

BRASS FITTINGS TECHNICAL INFORMATION

Pipe Thread

1. Pipe thread is normally tapered.
2. Use the chart to determine the size.

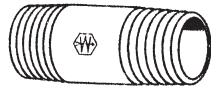

Pipe Size:

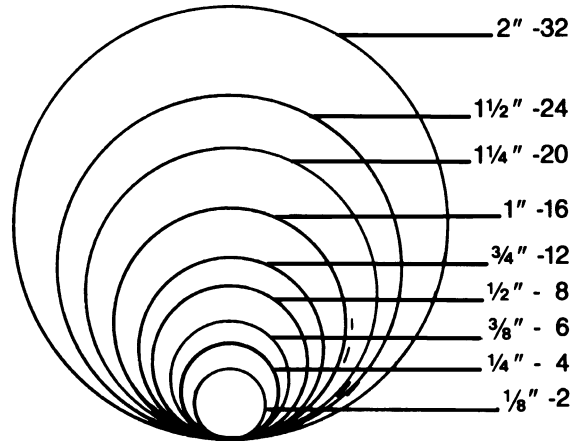

Compression Fittings

To identify look at the sleeves and bodies.

Air brake (copper)



Notice the sleeve is rounded.

Air brake (nylon)



The body will have the insert pressed into it. The sleeve has a support machined in the center of it.

Self align



If using plastic tube, an insert must be used.

Compression

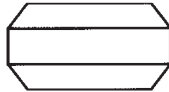

If using plastic tube, an insert must be used.

Polyline



Plastic sleeve, has insert machined into the body.

Flare

Use the chart to determine the size.

Brass:

Usually has a 45 degree angle cut. It is also called SAE 45. Society of Automotive Engineers

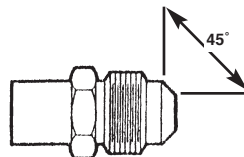

Steel:

Usually has a 37 degree angle cut. It is also called JIC 37. Joint Industrial Conference

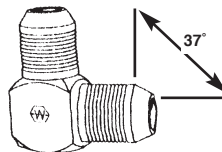

Inverted Flare

This fitting has a 45 degree chamfer cut on the inside. It is most often used in the automotive industry for the braking systems and the industrial air systems.

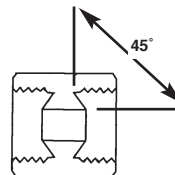

Tube

Tube is measured by the outside diameter OD.

Hose

Hose is measured by the inside diameter ID.

Pressure Specifications

Brass fittings are good for up to 2,000 P.S.I. (Pounds per Square Inch). Depending on the type and size of individual fittings. Steel fittings are good for up to 6,000 P.S.I. Depending on the type and size of individual fittings.

BRASS FITTING TECHNICAL INFORMATION

Tube Fitting Thread Size Comparison Chart

This chart gives the thread size for the different fitting styles and sizes. EXAMPLE: Compression fitting with 1/4" tube size has a thread size of 7/16-24.

Tube O.D.\Port size	1/8	3/16	1/4	5/16	3/8	7/16	1/2	5/8	3/4	7/8	1	1-1/4	1-1/2	2
Inverted	5/16	3/8	7/16	1/2	5/8	11/16	3/4	7/8	1-1/16	1-3/16	1-5/16	—	—	—
Flare	-28	-24	-24	-20	-18-	-18	-18	-18	-16	-16	-16	—	—	—
SAE 45°	5/16	3/8	7/16	1/2	5/8	11/16	3/4	7/8	1-1/16	—	—	—	—	—
Flare	-24	-24	-20	-20	-18	-16	-16	-14	-14	—	—	—	—	—
Compression	5/16	3/8	7/16	1/2	9/16	5/8	11/16	13/16	1	—	1-1/4	—	—	—
Self align	-24	-24	-24	-24	-24	-24	-20	-18	-18	—	-18	—	—	—
Polyline	5/16	3/8	3/8	7/16	1/2	—	11/16	—	—	—	—	—	—	—
	-24	-24	-24	-24	-24	—	-20	—	—	—	—	—	—	—
Air	—	—	7/16	—	17/32	—	11/16	13/16	1	—	1-1/4	—	—	—
Brake	—	—	-24	—	-24	—	-20	-18	-18	—	-16	—	—	—
SAE 37° (JIC)	5/16	3/8	7/16	1/2	9/16	—	3/4	7/8	1-1/16	1-3/16	1-5/16	1-5/8	1-7/8	2-1/2
Str. Thr'd O-Ring	-24	-24	-20	-20	-18	—	-16	-14	-12	-12	-12	-12	-12	-12
Eremeto® 7000 Ser.	—	—	9/16	—	11/16	—	13/16	1	1-3/16	—	1-7/16	1-11/16	2	2-1/2
FOR-SEAL™	—	—	-18	—	-16	—	-16	-14	-12	—	-12	-12	-12	-12

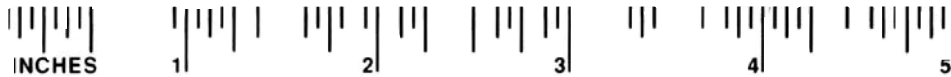
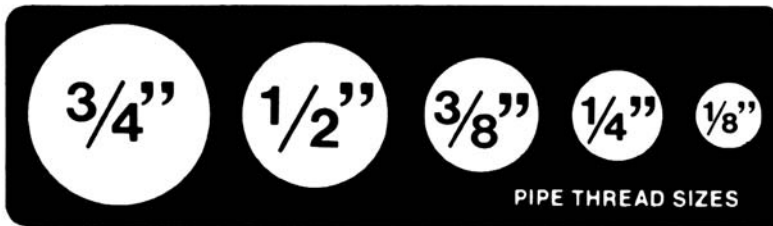
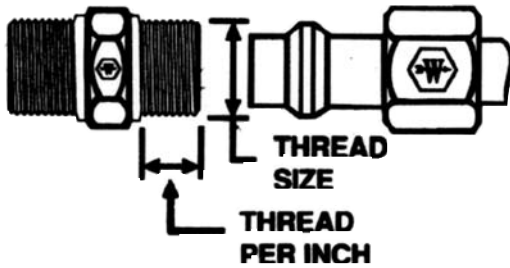

To Measure a Pipe Fitting: Measure the diameter of the 1st full thread and subtract 1/4 of an inch.

Example: Male thread diameter measures 3/4 of an inch

$$3/4" - 1/4" = 1/2" \text{ Pipe Thread}$$

Brass Pipe Fittings

F.T.N | Weatherhead

Pipe thread is always measured by outside diameter (OD) less 1/4". There are many different sizes for pipe so the outside diameter will change. The wall thickness and the process used in making the pipe will determine the amount of pressure a pipe can carry.

Brass pipe fittings are measured by pipe thread. They have NPTF male or female threads - a.k.a. "dryseal." Used with brass, copper, or iron pipe. Weatherhead® is a registered trademark.

How to Order: To order the premium domestic line of Weatherhead, use the 7 or 13-digit part numbers. To order the utility line, use the 5-digit part numbers.

Cap



FPT	Weatherhead		Utility	
	Part No.	Price /Each	Part No.	Price /Each
1/8"	440001-131280	\$0.92	69840	\$0.69
1/4"	440002-131280	1.34	69841	1.20
3/8"	440003-131280	1.69	69842	1.67
1/2"			69843	2.07
3/4"			69844	3.43

Slotted Plug

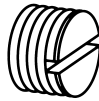

MPT	Vendor No.	Weatherhead		Utility	
		Part No.	Price /Each	Part No.	Price /Each
1/8"	3150X2	440004-131280	\$0.36	68609	\$0.32
1/4"	3150X4	440005-131280	0.51	68610	0.48
3/8"	3150X6	440006-131280	1.35	68611	1.32

Square Head Plug (Cored)

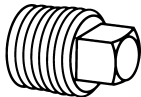

MPT	Weatherhead		Utility	
	Part No.	Price /Each	Part No.	Price /Each
1/8"	440007-131280	\$0.48	69845	\$0.48
1/4"	440008-131280	0.75	69846	0.73
3/8"	440009-131280	0.99	69847	0.96
1/2"	440010-131280	1.59	69848	1.54
3/4"	440011-131280	3.29	69849	3.07
1"			69519	7.52

Cored plug is standard.

Square Head Plug (Solid)

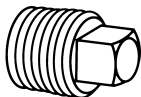

MPT	Part No.	Price /Each
3/8"	68586	0.84
1/2"	68587	4.83
3/4"	68588	5.99

Hex Head Plug (Cored)

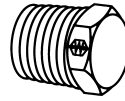

MPT	Weatherhead		Utility	
	Part No.	Price /Each	Part No.	Price /Each
1/8"	440012-131280	\$0.40	69904	\$0.28
1/4"	440013-131280	0.57	69905	0.48
3/8"	440014-131280	0.92	69906	0.88
1/2"	440015-131280	1.27	69907	1.53
3/4"	440016-131280	2.49	69908	2.44
1"			69909	8.39

Cored plug is standard.

Hex Head Plug (Solid)

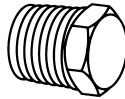

MPT	Part No.	Price /Each
1/8"	68612	\$0.42
1/4"	68613	0.62
3/8"	68614	1.15
1/2"	68615	1.84
3/4"	68616	3.41



7/8" Taper, Commercial Brass

- 7/8" Taper
- Flush steel
- Commercial brass



Size	T.P.I.	Key Size	Pkg. Qty.	Wt./100	Part No.	Price /Each
1/16"	27	5/32	100	.50	80742	\$0.48
1/8"	27	3/16	100	.80	80743	0.54
1/4"	18	1/4	100	2.00	80744	0.81
3/8"	18	5/16	100	4.00	80745	1.55
1/2"	14	3/8	50	2.90	80746	2.73
3/4"	14	9/16	50	5.10	80747	3.52

F.T.N | Weatherhead

Hex Countersunk Plug



MPT	Part No.	Price /Each
1/8"	68590	\$0.42
1/4"	68591	0.69
3/8"	68592	1.84
1/2"	68593	1.68
3/4"	68594*	5.69

*Square countersunk plug.

Locknut



FPT	Part No.	Price /Each
1/8"	68597	\$0.54
1/4"	68598	1.22
3/8"	68599	1.06
1/2"	68600	1.37

Bushing



MPT	FPT	Weatherhead		Utility	
		Part No.	Price /Each	Part No.	Price /Each
1/4"	1/8"	440017-131280	\$0.43	69850	\$0.42
3/8"	1/8"	440018-131280	0.70	69851	0.67
3/8"	1/4"	440019-131280	0.70	69852	0.63
1/2"	1/8"	440020-131280	1.34	69853	1.29
1/2"	1/4"	440021-131280	1.17	69854	1.15
1/2"	3/8"	440022-131280	1.21	69855	1.18
3/4"	1/8"			69856	2.77
3/4"	1/4"			69857	3.86
3/4"	3/8"	440023-131280	2.45	69858	2.41
3/4"	1/2"	440024-131280	1.57	69859	1.49
1"	1/4"			69362	6.57
1"	3/8"			69363	5.70
1"	1/2"			69364	4.82
1"	3/4"			69860	4.05

Union

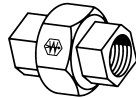

MPT	Vendor No.	Weatherhead		Utility	
		Part No.	Price /Each	Part No.	Price /Each
1/8"				68580	\$8.03
1/4"	3250X4	440026-131280	9.72	68581	9.49
3/8"				68582	15.32
1/2"	3250X8	440028-131280	16.83	68583	16.50
3/4"				68584	23.24

Coupling



440034-131280

440029-131280

FPT	Vendor No.	Weatherhead		Utility	
		Part No.	Price /Each	Part No.	Price /Each
1/8"	3300X2	440029-131280	\$0.60	69835	\$0.54
1/4"	3300X4	440030-131280	1.00	69836	0.95
1/4"x1/8"	3300X4X2	440034-131280	1.27	69890	0.90
3/8"	3300X6	440031-131280	1.48	69837	1.39
3/8"x1/8"	3300X6X2	440035-131280	1.69	69891	2.69
3/8"x1/4"	3300X6X4	440036-131280	1.57	69892	1.27
1/2"	3300X8	440032-131280	2.55	69838	2.51
1/2 x1/8				69252	3.78
1/2 x1/4				69893	2.62
1/2"x3/8"	3300X8X6	440037-131280	3.27	69894	2.15
3/4"	3300X12	440033-131280	4.58	69839	3.49
3/4 x1/2				69895	3.94

Adapter

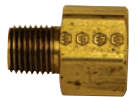

FPT	MPT	Vendor No.	Weatherhead		Utility	
			Part No.	Price /Each	Part No.	Price /Each
1/8"	1/8"	3200X2	440038-131280	\$0.64	69896	\$0.51
1/4"	1/8"	3200X4X2	440039-131280	1.34	69897	0.85
1/4"	1/4"	3200X4	440040-131280	1.48	69898	0.87
3/8"	1/8"				69253	1.83
3/8"	1/4"	3200X6X4	440041-131280	1.65	69899	1.54
3/8"	3/8"	3200X6	440042-131280	1.77	69900	1.60
1/2"	1/4"				69254	2.91
1/2"	3/8"	3200X8X6	440043-131280	2.69	69901	2.55
1/2"	1/2"				69902	2.51
3/4"	3/8"	3200X12X6	440044-131280	9.86		
3/4"	1/2"	3200X12X8	440045-131280	6.79	69903	3.63

BRASS PIPE FITTINGS

Brass Pipe Fittings Cont.

FAT-N | Weatherhead

Brass Fittings

Nipple (Close & Long)



Close Nipple



Long Nipple

MPT	Length	Vendor No.	Weatherhead		Utility	
			Part No.	Price /Each	Part No.	Price /Each
Close Nipple						
1/8	-	3326X2	440054-131280	0.35	69861	\$0.33
1/4	-	3326X4	440055-131280	0.49	69862	0.47
3/8	-	3326X6	440056-131280	0.73	69863	0.71
1/2	-	3326X8	440057-131280	1.08	69864	1.41
3/4	-	3326X12	440058-131280	3.83	69865	3.34
1	-				69260	6.08
Long Nipple						
1/8	1-1/2	3327X2	440059-131280	0.64	69866	0.53
1/4	1-1/2	3327X4	440060-131280	1.13	69870	0.93
3/8	1-1/2	3327X6	440061-131280	3.24	69874	1.52
1/2	1-1/2				69261	1.89
3/4	1-1/2				69262	2.42
1/8	2	3328X2	440062-131280	0.90	69867	0.88
1/4	2	3328X4	440063-131280	1.20	69871	1.14
3/8	2	3328X6	440064-131280	2.63	69875	1.46
1/2	2	3328X8	440065-131280	4.67	69879	2.38
3/4	2				69263	3.08
1/8	2-1/2	3329X2	440067-131280	1.19	69868	1.07
1/4	2-1/2	3329X4	440068-131280	3.21	69872	1.26
3/8	2-1/2	3329X6	440069-131280	3.90	69876	1.65
1/2	2-1/2	3329X8	440070-131280	3.57	69264	2.93
3/4	2-1/2	3329X12	440071-131280	5.88	69265	4.93
1/8	3	3330X2	440072-131280	2.71	69869	1.79
1/4	3	3330X4	440073-131280	3.33	69873	3.09
3/8	3	3330X6	440074-131280	4.39	69877	2.79
1/2	3	3330X8	440075-131280	6.87	69729	3.62
3/4	3				69266	6.13
1/8	3-1/2				69267	2.74
1/4	3-1/2				69268	3.41
3/8	3-1/2				69269	4.09
1/2	3-1/2				69270	5.65
3/4	3-1/2				69271	7.10
1/8	4				69272	3.16
1/4	4				69273	4.03
3/8	4				69878	4.72
1/2	4				69274	6.13
3/4	4				69275	7.77
1/8	4-1/2				69276	3.24
1/4	4-1/2				69277	4.31
3/8	4-1/2				69278	5.13
1/2	4-1/2				69279	7.23
3/4	4-1/2				69280	8.19
1/8	5				69281	3.53
1/4	5				69282	4.25
3/8	5				69283	5.80
1/2	5				69284	8.29
3/4	5				69285	9.35
1/8	5-1/2				69286	3.83
1/4	5-1/2				69287	5.20
3/8	5-1/2				69288	6.07
1/2	5-1/2				69289	8.38
3/4	5-1/2				69290	9.75
1/8	6				69291	4.09
1/4	6				69292	5.67
3/8	6				69293	6.42
1/2	6				69294	9.14
3/4	6				69295	11.05

Hex Nipple



MPT	Vendor No.	Weatherhead		Utility	
		Part No.	Price /Each	Part No.	Price /Each
1/8	3325X2	440046-131280	\$0.57	69950	\$0.48
1/4x1/8*	3325X4X2	440051-131280	0.85	69247	0.71
1/4	3325X4	440047-131280	0.92	69951	0.76
3/8x1/8*	3325X6X2	440052-131280	1.77	69248	1.18
3/8x1/4*	3325X6X4	440053-131280	1.98	69249	1.25
3/8	3325X6	440048-131280	1.42	69952	1.30
1/2x1/4*				69250	4.38
1/2x3/8*				69984	2.29
1/2	3325X8	440049-131280	2.83	69953	2.15
3/4x1/2*				69251	3.87
3/4	3325X12	440050-131280	5.39	69954	2.82

*Reducing Hex Nipple

45° Street Elbow



FPT	MPT	Vendor No.	Weatherhead		Utility	
			Part No.	Price /Each	Part No.	Price /Each
1/8	1/8	3350X2	440079-131280	\$1.44	69910	\$1.33
1/4	1/4	3350X4	440080-131280	1.99	69911	1.95
3/8	3/8	3350X6	440081-131280	2.65	69912	2.58
1/2	1/2	3350X8	440082-131280	5.53	69913	5.43
3/4	3/4	3350X12	440083-131280	10.98	69959	10.52

90° Street Elbow



FPT	MPT	Vendor No.	Weatherhead		Utility	
			Part No.	Price /Each	Part No.	Price /Each
1/8	1/8*	3400X2	440084-131280	\$0.93	69880	\$0.88
1/8	1/8 F*				69255	2.61
1/8"	1/8"	3400X2W	440085-131280	1.46		
1/4	1/8*	3400X4X2	440086-131280	2.30		
1/4"	1/4"	3400X4W	440087-131280	2.85		
1/4	1/4*	3400X4	440088-131280	1.59	69881	1.57
1/4	1/4 F*				69257	3.45
3/8	3/8*	3400X6	440089-131280	1.85	69882	1.79
3/8	3/8 F*				69258	3.92
1/2	1/2*	3400X8	440090-131280	3.95	69883	3.89
1/2	1/2 F*				69259	5.64
3/4	3/4*	3400X12	440091-131280	7.29	69884	6.95

F = Forged

* May be rounded bottom

90° Male Elbow

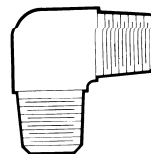

MPT	Part No.	Price /Each
1/8 x 1/8	68602	\$2.28
1/4 x 1/4	68603	2.74
1/4 x 1/8	68604	3.05
3/8 x 3/8	68605	4.53
3/8 x 1/4	68606	4.01
1/2 x 1/2	68607	5.76
1/2 x 3/8	68608	5.27

Female Cross

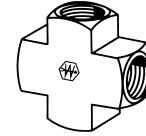

FPT	Vendor No.	Weatherhead		Utility	
		Part No.	Price /Each	Part No.	Price /Each
1/8	3950X2	440092-131280	\$2.75	68575	\$2.69
1/4	3950X4	440093-131280	4.09	68576	3.99
3/8	3950X6	440094-131280	8.02	68577	7.57
1/2	3950X8	440095-131280	10.49	68578	10.35
3/4				68579	12.38

90° Female Elbow



FPT	Vendor No.	Weatherhead		Utility	
		Part No.	Price /Each	Part No.	Price /Each
1/8	3500X2	440097-131280	\$1.55	68563	\$1.50
1/8 F				68564	1.99
1/4	3500X4	440098-131280	1.99	68565	1.95
1/4 F				68566	3.36
1/4 x 1/8				68567	3.99
3/8	3500X6	440099-131280	2.99	68568	2.94
3/8 F				68569	4.35
1/2	3500X8	440100-131280	5.59	68570	5.45
1/2 F				68571	6.15
1/2 x 3/8				68572	7.69
3/4	3500X12	440101-131280	8.90	68573	8.83
3/4 F				68574	12.31

F = Forged

45° Female Elbow

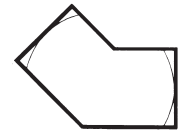

FPT	Part No.	Price /Each
1/8	69885	\$3.82
1/4	69886	5.83
3/8	69887	6.25
1/2	69888	9.21

Street Tee (F x M x F)



FPT x MPT x FPT	Vendor No.	Weatherhead		Utility	
		Part No.	Price /Each	Part No.	Price /Each
1/8	3750X2	440102-131280	\$1.55	69955	\$1.49
1/4	3750X4	440103-131280	2.75	69956	2.69
3/8	3750X6	440104-131280	3.98	69957	3.95
1/2	3750X8	440105-131280	11.82		
3/4	3750X12	440106-131280	19.23		

BRASS PIPE FITTINGS & BRASS SAE 45° FLARE

Brass Pipe Fittings Cont.

F.T.N | Weatherhead

Street Tee (F x M x M)

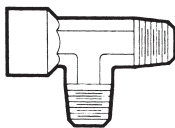

FPT x MPT x MPT	Part No.	Price /Each
1/8	68617	\$3.88
1/4	68618	5.27

Female Tee

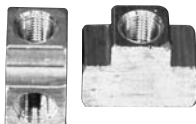

		Weatherhead		Utility	
FPT	Vendor No.	Part No.	Price /Each	Part No.	Price /Each
1/8	3700X2	440107-131280	\$1.59	69825	\$1.54
1/8 F				69830	2.53
1/4	3700X4	440108-131280	2.42	69826	2.35
1/4 F				69831	3.74
1/4 x1/4 x1/8				69770	4.55
3/8	3700X6	440109-131280	3.49	69827	3.45
3/8 F				69832	5.31
3/8 x3/8 x1/4				69969	8.61
1/2	3700X8	440110-131280	5.55	69828	6.25
1/2 F				69833	8.32
1/2 x1/2 x3/8				0481000	8.69
3/4	3700X12	440111-131280	11.24	69829	10.46
3/4 F				69834	12.30

F = Forged

Bulkhead

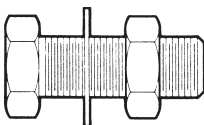

MPT	Length	Part No.	Price /Each
1/8	-	67885	\$4.18
1/4	.92	67886	3.85
1/4	1.5	67887	4.70
3/8	-	67888	6.19
1/2	-	67889	8.73

Male Branch Tee

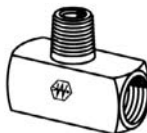

MPT	FPT	Vendor No.	Part No.	Price /Each
1/8	1/8	3600X2	424506-131280	\$2.27
1/4	1/8	3600X4	424507-131280	4.24
3/8	3/8	3600X6	424508-131280	6.55
1/2	1/2	3600X8	424509-131280	10.80
3/4	3/4	3600X12	424510-131280	15.77

Brass SAE 45° Flare

SAE 45° Flare fittings offer good working pressures with metal hydraulic tubing that can be flared.

Short Nut (Forged)

Works with copper, brass, aluminum and steel hydraulic tubing that can be flared.



Tube O.D.	Part No.	Price /Each
3/16	67452	\$2.03
1/4	67453	0.72
5/16	67454	1.15
3/8	67455	0.93
1/2	67456	1.20
5/8	67457	1.80
3/4	67458	5.19
7/8	67459	11.54

Short Forged Nut (Reducing)



Tube O.D.	Part No.	Price /Each
1/4 x3/16	67460	\$2.14
3/8 x1/4	67462	1.49
3/8 x5/16	67463	2.74
1/2 x3/8	67464	1.77
5/8 x3/8	67465	6.38
5/8 x1/2	67466	2.70

Long Nut (Machined)

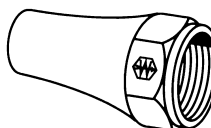

		Weatherhead		Utility	
Tube O.D.	Vendor No.	Part No.	Price /Each	Part No.	Price /Each
1/8				69500	\$2.13
3/16	41X3	440124-131280	0.55	69501	0.51
1/4	41X4	440125-131280	0.53	69502	0.49
5/16	41X5	440126-131280	0.69	69503	0.66
3/8	41X6	440127-131280	1.09	69504	1.04
1/2	41X8	440128-131280	1.89	69505	1.70
5/8				69506	3.00
3/4				69507	10.03

Short Nut (Machined)

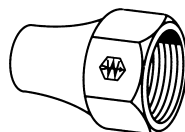

		Weatherhead		Utility	
Tube O.D.	Vendor No.	Part No.	Price /Each	Part No.	Price /Each
1/8	1110X2	440115-131280	\$0.46	67430	\$0.33
3/16	1110X3	440116-131280	0.30	67431	0.27
1/4	1110X4	440117-131280	0.48	67432	0.45
5/16	1110X5	440118-131280	0.82	67433	0.57
3/8	1110X6	440119-131280	0.79	67434	0.70
1/2	1110X8	440121-131280	1.15	67437	1.11
5/8	1110X10	440122-131280	1.99	67439	1.46
3/4				67441	4.69

Machined Nut (SAE Standard)

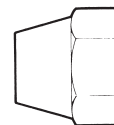

Tube O.D.	Part No.	Price /Each
3/8	67424	\$2.66
1/2	67425	3.33
5/8	67426	3.17

Cap

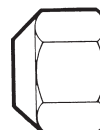

Tube O.D.	Part No.	Price /Each
3/16	67469	\$1.62
1/4	67470	0.30
5/16	67471	1.13
3/8	67472	0.57
1/2	67473	0.80
5/8	67474	1.31
3/4	67475	6.43

Plug

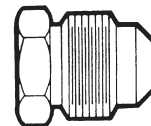

Tube O.D.	Part No.	Price /Each
3/16	67476	\$3.63
1/4	67477	0.45
5/16	67478	1.44
3/8	67479	0.82
1/2	67480	1.47
5/8	67481	1.84
3/4	67482	9.34

Cross

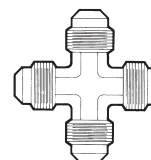

Tube O.D.	Part No.	Price /Each
3/8	67379	\$6.90
1/2	67381	10.91
5/8	67382	20.14

Tube all ends.

Brass Fittings

BRASS SAE 45° FLARE

Brass SAE 45° Flare Cont.

F.T.N | Weatherhead

Brass Fittings

90° Male Elbow

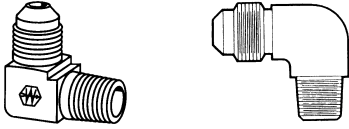

Tube O.D.	MPT	Weatherhead		Utility		
		Vendor No.	Part No.	Price /Each	Part No.	Price /Each
1/8	1/8	49X2	440130-131280	\$3.35	69560	\$3.29
3/16	1/8 F				69556	2.77
3/16	1/4	49X3	440131-131280	1.32	69561	1.29
3/16	1/4				69562	2.33
1/4	1/8 F				67341	1.93
1/4	1/8	49X4	440132-131280	1.18	69563	1.14
1/4	1/4	49X4X4	440133-131280	1.39	69564	1.36
1/4	1/4 F				69557	2.19
1/4	3/8	49X4X6	440134-131280	3.48	69565	2.36
1/4	1/2				69566	4.09
5/16	1/8 F				69558	3.10
5/16	1/8	49X5	440135-131280	1.55	69567	1.53
5/16	1/4 F				69559	3.06
5/16	1/4	49X5X4	440136-131280	1.69	69568	1.67
5/16	3/8				69569	3.12
3/8	1/8	49X6X2	440137-131280	2.06	69570	1.99
3/8	1/4 F				67364	2.29
3/8	1/4	49X6	440138-131280	1.93	69571	1.89
3/8	3/8 F				69586	2.64
3/8	3/8		440139-131280	2.39	69572	2.35
3/8	1/2	49X6X8	440140-131280	3.25	69573	2.91
3/8	3/4				69574	4.65
1/2	1/4 F				69587	3.42
1/2	1/4	49X8X4	440142-131280	3.19	69575	3.16
1/2	3/8 F				69588	3.16
1/2	3/8	49X8	440143-131280	2.54	69576	2.33
1/2	1/2 F				69589	3.92
1/2	1/2	49X8X8	440144-131280	3.14	69577	3.07
1/2	3/4				69578	5.01
5/8	1/4				69400	6.09
5/8	3/8	49X10X6	440145-131280	5.16	69579	4.08
5/8	1/2 F				69406	5.32
5/8	1/2	49X10	440146-131280	3.95	69580	3.92
5/8	3/4				69581	5.89
3/4	3/8				69453	11.68
3/4	1/2	49X12	440147-131280	6.85	69582	6.77
3/4	3/4	49X12X12	440148-131280	8.64	69583	7.73
7/8	3/4				69584	16.44

F = Forged

45° Male Elbow

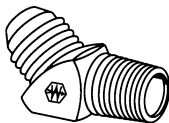

Tube O.D.	MPT	Weatherhead		Utility		
		Vendor No.	Part No.	Price /Each	Part No.	Price /Each
1/4	1/8	54X4	440149-131280	\$1.67	69610	\$1.55
1/4	1/4	54X4X4	440150-131280	4.09	69611	2.84
5/16	1/8	54X5	440151-131280	2.52	69612	2.49
5/16	1/4				69613	3.17
3/8	1/4	54X6	440152-131280	2.55	69614	2.51
3/8	3/8				69615	3.66
3/8	1/2				69616	6.75
1/2	3/8	54X8	440154-131280	3.48	69617	3.43
1/2	1/2	54X8X8	440155-131280	6.15	69618	6.03
5/8	3/8	54X10X6	440156-131280	7.85	69465	6.66
5/8	1/2	54X10	440157-131280	5.25	69619	5.19
3/4	1/2				69468	8.80
3/4	3/4				69469	12.56

90° Union Elbow

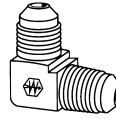

Tube O.D.	Part No.	Price /Each
1/8	67390	\$3.14
3/16	67391	2.94
1/4	67392	1.59
5/16	67393	2.32
3/8 F	67394	2.93
3/8	67395	2.32
1/2	67396	3.22
5/8	67397	4.20
3/4	67398	9.73

F = Forged

90° Female Elbow



Tube O.D.	FPT	Weatherhead		Utility		
		Vendor No.	Part No.	Price /Each	Part No.	Price /Each
1/4	3/8			67359	\$4.01	
3/16	1/8			69590	3.72	
1/4	1/8	50X4	440164-131280	1.85	69591	1.82
1/4	1/4	50X4X4	440165-131280	2.89	69592	2.75
5/16	1/4			69595	3.17	
3/8	1/8			69596	2.67	
3/8	1/4 F			69593	3.19	
3/8	1/4	50X6	440168-131280	2.79	69597	2.34
3/8	3/8 F			69510	2.61	
3/8	3/8			69598	2.29	
3/8	1/2			69599	4.20	
1/2	1/4			69601	4.10	
1/2	3/8			69602	3.36	
1/2	1/2			69603	3.40	
1/2	3/4			69604	4.70	
5/8	3/8			69605	5.82	
5/8	1/2	50X10	440172-131280	7.12	69606	4.10
5/8	3/4			69607	4.86	
3/4	1/2			69608	12.38	
3/4	3/4			69609	16.76	

F = Forged

90° Female Flare Swivel Elbow

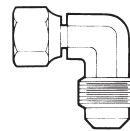

Tube O.D.	Part No.	Price /Each
1/4 x1/4	67417	\$10.00
3/8 x3/8	67418	14.13
1/2 x1/2	67419	21.38
5/8 x5/8	67420	21.67

Refrigerant Drum Cylinder Valve Adapter

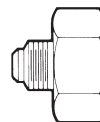

Tube O.D.	Part No.	Price /Each
1/4 x1/2	67422	\$9.83
1/4 x3/4	67423	7.42

Male Branch Tee

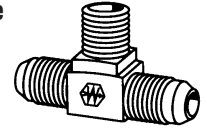

Tube O.D.	MPT	Part No.	Price /Each
1/8	1/8	67483	\$12.49
3/16	1/8	67484	3.62
1/4	1/8 F	67485	2.64
1/4	1/8	67486	2.01
1/4	1/4	67487	2.37
1/4	3/8	67488	3.71
5/16	1/8	67489	4.33
5/16	1/4	67490	3.54
3/8	1/8	67491	3.33
3/8	1/4	67492	2.75
3/8	3/8	67493	3.42
3/8	1/2	67494	6.04
1/2	1/4	67496	5.15
1/2	3/8	67497	4.55
1/2	1/2	67498	6.29
1/2	3/4	67499	14.35
5/8	3/8	67500	7.97
5/8	1/2	67501	8.29
3/4	1/2	67502	21.79
3/4	3/4	67503	13.66

F = Forged

Union Tee

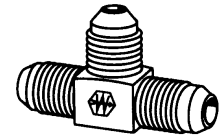

Tube O.D.	Part No.	Price /Each
1/8	67512	\$3.16
3/16	67513	2.28
1/4 F	67514	2.58
1/4	67515	2.25
5/16	67516	2.99
3/8 F	67517	3.10
3/8	67518	2.17
1/2	67519	3.35
5/8	67520	4.95
3/4	67521	12.91

F = Forged

Male Run Tee

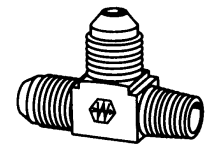

Tube O.D.	MPT	Part No.	Price /Each
1/4	1/8	67548	\$2.26
1/4	1/4	67549	3.12
1/4	3/8	67550	4.46
5/16	1/8	67551	3.84
5/16	1/4	67552	4.95
3/8	1/8	67553	3.47
3/8	1/4	67554	3.50
3/8	3/8	67555	3.47
3/8	1/2	67556	6.03
1/2	3/8	67558	5.47
1/2	1/2	67559	6.45
1/2	3/4	67560	18.98
5/8	3/8	67561	7.07
5/8	1/2	67562	7.54
3/4	1/2	67563	21.99
3/4	3/4	67564	17.08

BRASS SAE 45° FLARE & BRASS INVERTED FLARE FITTINGS

Brass SAE 45° Flare Cont.

F.T.N. | Weatherhead

Street Adapter Tee

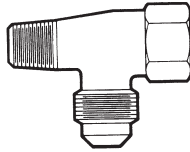

Tube O.D.	Part No.	Price /Each
1/4 x1/8	67568	\$3.36

Union

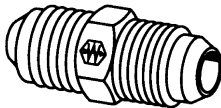

Tube O.D.	Vendor No.	Weatherhead		Utility	
		Part No.	Price /Each	Part No.	Price /Each
3/16	42X3	440202-131280	1.37	69521	\$1.12
1/4	42X4	440203-131280	0.68	69522	0.62
5/16	42X5	440204-131280	0.90	69523	0.72
3/8	42X6	440205-131280	1.31	69524	1.29
1/2	42X8	440206-131280	1.79	69525	1.77
5/8	42X10	440207-131280	4.09	69526	2.58
3/4				69527	5.73
7/8				69528	12.92

Reducing Union

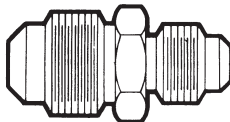

Tube O.D.	Part No.	Price /Each
3/8 x1/4	67570	\$1.13
3/8 x5/16	67571	4.98
1/2 x1/4	67572	3.46
1/2 x3/8	67573	1.68
5/8 x3/8	67340	2.39
5/8 x1/2	67574	2.26
3/4 x1/2	67575	7.41
3/4 x5/8	67576	16.67

Male Connector

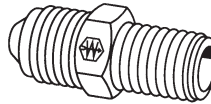

Tube O.D.	MPT	Vendor No.	Weatherhead		Utility	
			Part No.	Price /Each	Part No.	Price /Each
1/8	1/8	48X2	440209-131280	\$1.18	69530	\$1.79
3/16	1/8	48X3	440210-131280	0.55	69531	0.53
1/4	1/8	48X4	440211-131280	0.49	69532	0.48
1/4	1/4	48X4X4	440212-131280	0.71	69533	0.60
1/4	3/8				69534	0.91
1/4	1/2				69535	1.80
5/16	1/8	48X5	440213-131280	0.59	69536	0.55
5/16	1/4	48X5X4	440214-131280	0.80	69537	0.74
5/16	3/8				69538	1.72
3/8	1/8	48X6X2	440215-131280	1.04	69539	0.78
3/8	1/4	48X6	440216-131280	0.96	69540	0.95
3/8	3/8	48X6X6	440217-131280	1.28	69541	1.17
3/8	1/2	48X6X8	440218-131280	2.42	69542	1.47
3/8	3/4				69543	2.17
7/16	1/4				69529	3.86
1/2	1/4	48X8X4	440220-131280	2.17	69544	1.12
1/2	3/8	48X8	440221-131280	1.52	69545	1.41
1/2	1/2	48X8X8	440222-131280	2.06	69546	1.65
1/2	3/4				69547	2.38
5/8	1/4				69548	4.90
5/8	3/8	48X10X6	440223-131280	2.58	69549	1.79
5/8	1/2	48X10	440224-131280	1.98	69550	1.95
5/8	3/4				69551	2.48
3/4	1/2	48X12	440225-131280	4.29	69552	4.15
3/4	3/4	48X12X12	440226-131280	4.84	69553	4.53
7/8	3/4				69555	10.89

Male Ball Check Connector

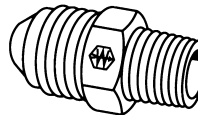

Tube O.D.	MPT	Vendor No.	Part No.	Price /Each
1/4	1/8	43X4	440227-131280	\$4.87
3/8	1/4	43X6	440229-131280	6.17

Female Connector

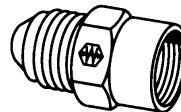

Tube O.D.	FPT	Vendor No.	Weatherhead		Utility	
			Part No.	Price /Each	Part No.	Price /Each
1/8	1/8				67630	\$2.48
3/16	1/8				67631	0.84
1/4	1/8	46X4	440231-131280	0.73	67632	0.61
1/4	1/4	46X4X4	440232-131280	1.48	67587	0.89
1/4	3/8				67588	3.28
5/16	1/8	46X5	440233-131280	1.15	67589	1.10
5/16	1/4				67590	1.15
3/8	1/8				67591	1.04
3/8	1/4	46X6	440236-131280	1.90	67592	1.01
3/8	3/8	46X6X6	440237-131280	1.15	67593	1.13
3/8	1/2				67594	1.38
3/8	3/4				67595	2.49
1/2	1/4				67596	1.30
1/2	3/8	46X8	440240-131280	2.45	67597	1.31
1/2	1/2				67598	1.62
1/2	3/4				67599	2.11
5/8	3/8				67600	2.14
5/8	1/2				67601	1.59
5/8	3/4				67602	4.37
3/4	1/2				67603	12.92
3/4	3/4				67604	10.44

Flare Connector

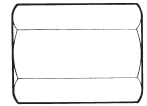

Tube O.D.	Part No.	Price /Each
1/4	67614	\$5.11
3/8	67615	7.96
1/2	67616	10.37

Female Adapter

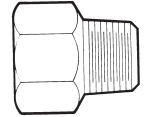

Tube O.D.	MPT	Part No.	Price /Each
1/4	1/8	67617	\$7.25
1/4	1/4	67618	7.18
3/8	1/4	67619	10.19
1/2	3/8	67620	9.79

Reducer Connector Flare

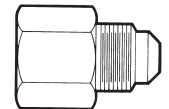

Tube O.D.	Part No.	Price /Each
1/4 x3/8	67577	\$2.56
3/8 x1/4	67578	4.27
3/8 x1/2	67579	3.31
1/2 x3/8	67580	4.05
3/8 x5/8	67581	5.46
5/8 x1/2	67583	5.00

Brass Inverted Flare Fittings

Tube Nut Steel

Inverted flare fittings offer good working pressures with metal hydraulic tubing that can be flared. Seats are threaded and protected. Can be used with copper, brass and steel hydraulic tubing that can be flared.

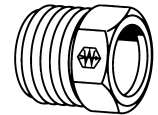

Tube O.D.	Vendor No.	Weatherhead		Utility	
		Part No.	Price /Each	Part No.	Price /Each
1/8	105X2	440243-131280	\$0.42	67736	\$0.41
3/16	105X3	440244-131280	0.17	67737	0.14
1/4	105X4	440245-131280	0.15	67738	0.14
5/16	105X5	440246-131280	0.18	67739	0.17
3/8	105X6	440247-131280	0.33	67740	0.32
3/8 (11/16 MPT)	105X6X7	440248-131280	2.32		
7/16	105X7	440249-131280	0.58		
1/2	105X8	440250-131280	0.53		
5/8	105X10	440251-131280	1.40		
3/4	105X12	440252-131280	2.03		
7/8	105X14	440253-131280	3.23		

Tube Nut Brass

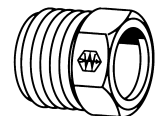

Tube O.D.	Vendor No.	Weatherhead		Utility	
		Part No.	Price /Each	Part No.	Price /Each
1/8				69620	\$1.00
3/16	100X3	440255-131280	0.33	69621	0.32
1/4	100X4	440256-131280	0.34	69622	0.33
5/16	100X5	440257-131280	0.35	69623	0.34
3/8	100X6	440258-131280	0.52	69624	0.51
1/2	100X8	440259-131280	1.04	69625	0.93

The : symbol after a price denotes that it is a Direct Ship Product (DSP) and shipping, availability & lead times may vary.

HYDRAULICS, PNEUMATICS & POWER TRANSMISSION

BRASS INVERTED FLARE FITTINGS & BRASS THREADED SLEEVES

Brass Inverted Flare Fittings Cont.

Brass Fittings

F.T.N. | Weatherhead

Tube Nut (Long Steel)

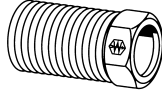

Tube O.D.	Vendor No.	Part No.	Price /Each
3/16	7896X3	440260-131280	\$1.06
1/4	7896X4	440261-131280	1.12

Union

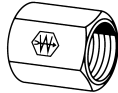

Tube O.D.	Vendor No.	Weatherhead		Utility	
		Part No.	Price /Each	Part No.	Price /Each
1/8	302X2	440262-131280	\$1.17	69630	\$1.12
3/16	302X3	440263-131280	0.69	69631	0.65
1/4	302X4	440264-131280	0.59	69632	0.58
5/16	302X5	440265-131280	0.86	69633	0.70
3/8	302X6	440266-131280	1.18	69634	1.16
1/2	302X8	440267-131280	2.69	69635	6.15

Plug (Steel)

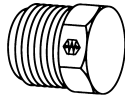

Tube O.D.	Vendor No.	Weatherhead		Utility	
		Part No.	Price /Each	Part No.	Price /Each
3/16	131X3	440269-131280	\$0.35	69626	\$0.35
1/4	131X4	440270-131280	0.47	69627	0.47
5/16	131X5	440271-131280	0.50	69628	0.51
3/8	131X6	440272-131280	1.29	69629	1.25

Union Tee



Tube O.D.	Vendor No.	Weatherhead		Utility	
		Part No.	Price /Each	Part No.	Price /Each
1/8	702X2	440273-131280	\$4.39		
3/16	702X3	440274-131280	1.98	67744	1.95
1/4	702X4	440275-131280	2.25	67745	2.19
5/16	702X5	440276-131280	3.35	67746	3.30
3/8	702X6	440277-131280	5.15	67747	4.98
1/2				67748	9.19

Female Connector

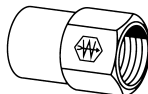

Tube O.D.	FPT	Vendor No.	Weatherhead		Utility	
			Part No.	Price /Each	Part No.	Price /Each
3/16	1/8	252X3	440299-131280	\$1.69	67749	\$1.67
1/4	1/8	252X4	440300-131280	0.94	67750	0.93
5/16	1/8	252X5	440301-131280	2.35	67751	0.92
3/8	1/4				67752	1.93
1/2	3/8				67753	4.28

Male Connector

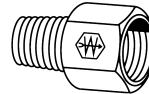

Tube O.D.	MPT	Vendor No.	Weatherhead		Utility	
			Part No.	Price /Each	Part No.	Price /Each
1/8	1/8	202X2	440280-131280	\$1.45		
3/16	1/8	202X3	440281-131280	0.39	69636	0.39
1/4	1/8	202X4	440282-131280	0.45	69637	0.43
1/4	1/4	202X4X4	440283-131280	0.79	69638	0.75
5/16	1/8	202X5	440284-131280	0.52	69639	0.50
5/16	1/4	202X5X4	440285-131280	0.72	69640	0.70
3/8	1/8	202X6X2	440286-131280	1.07	69641	1.04
3/8	1/4	202X6	440287-131280	0.95	69642	0.94
3/8	3/8	202X6X6	440288-131280	1.35	69643	1.32
7/16	1/4				69644	3.20
1/2	1/4	202X8X4	440290-131280	5.53		
1/2	3/8	202X8	440291-131280	1.85	69511	1.69
1/2	1/2	202X8X8	440292-131280	1.95	69645	1.90
5/8	1/2	202X10	440293-131280	4.31	69646	3.43
3/4	1/2				69647	9.00
3/4	3/4	202X12	440295-131280	7.54		
7/8	3/4	202X14	440296-131280	16.62		

90° Union Elbow

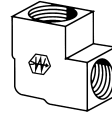

Tube O.D.	Vendor No.	Part No.	Price /Each
1/4	502X4	440307-131280	\$1.70

90° Male Elbow

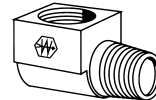

Tube O.D.	MPT	Vendor No.	Weatherhead		Utility	
			Part No.	Price /Each	Part No.	Price /Each
1/8	1/8	402X2	440311-131280	\$1.59	69648	\$1.59
3/16	1/8	402X3	440312-131280	0.83	69649	0.98
1/4	1/8	402X4	440313-131280	0.85	69650	1.16
*1/4	1/8	431X4	0440314	2.44		
1/4	1/4	402X4X4	440315-131280	1.59	69651	1.87
5/16	1/8	402X5	440316-131280	0.99	69652	1.19
5/16	1/4	402X5X4	440317-131280	2.39	69653	2.35
3/8	1/8	402X6X2	440319-131280	2.15		
3/8	1/4	402X6	440320-131280	2.25	69655	2.25
3/8	3/8	402X6X6	440321-131280	4.51	69656	3.04
1/2	1/4				69659	4.76
1/2	3/8	402X8	440324-131280	3.65	69657	3.59
1/2	1/2	402X8X8	440325-131280	4.92	69658	4.85
5/8	1/2				69659	9.80
3/4	1/2	402X12X8	440328-131280	14.07		
7/8	3/4	402X14	440330-131280	21.26		
1	1	402X16	440331-131280	24.97		

* .062 restricted orifice

45° Male Elbow

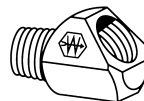

Tube O.D.	MPT	Vendor No.	Weatherhead		Utility	
			Part No.	Price /Each	Part No.	Price /Each
3/16	1/8	352X3	440333-131280	\$1.89	67759	\$3.45
1/4	1/8	352X4	440334-131280	1.95	67760	1.92
5/16	1/8	352X5	440335-131280	2.49	67761	2.49
5/16	1/4				67762	3.77
3/8	1/4	352X6	440338-131280	3.72	67763	3.72
1/2	3/8				67764	6.03

90° Female Elbow

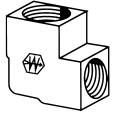

Tube O.D.	FPT	Vendor No.	Part No.	Price /Each
1/4	1/8	452X4	440342-131280	\$2.25
3/8	1/4	452X6	440344-131280	4.70

Male Run Tee

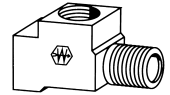

Tube O.D.	MPT	Vendor No.	Part No.	Price /Each
1/4	1/8	752X4	440348-131280	\$1.98

Male Branch Tee

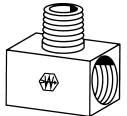

Tube O.D.	MPT	Vendor No.	Part No.	Price /Each
3/16	1/8	602X3	440352-131280	\$2.20
1/4	1/8	602X4	440353-131280	3.59
5/16	1/8	602X5	440354-131280	3.42
3/8	1/4	602X6	440355-131280	4.26

Female Branch Tee

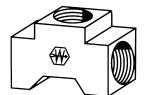

Tube O.D.	MPT	Vendor No.	Part No.	Price /Each
3/16	1/8	652X3	440357-131280	\$5.96

Brass Threaded Sleeves

Nut

Brass threaded sleeve products are used in low-pressure oil, air, water and lubrication systems. Threaded sleeve is two-piece construction. "DOUBLE COMPRESSION"

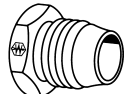

Tube O.D.	Vendor No.	Part No.	Price /Each
1/8	6100X2	440934-131280	\$0.43
3/16	6100X3	440935-131280	0.58
1/4	6100X4	440936-131280	0.55

Male Connector

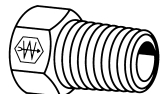

Tube O.D.	MPT	Vendor No.	Part No.	Price /Each
1/8	1/8	6200X2	440941-131280	\$0.49
1/8	1/4-28	6200X2X21	440942-131280	1.10
3/16	1/8	6200X3	440943-131280	0.97
1/4	1/8	6200X4	440944-131280	0.73

Male Elbow

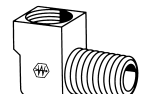

Tube O.D.	MPT	Vendor No.	Part No.	Price /Each
1/8	1/8	6400X2	440947-131280	\$2.94
1/8	1/4-28	6400X2X21	440948-131280	2.43
3/16	1/8	6400X3	440949-131280	3.77
1/4	1/8	6400X4	440950-131280	3.72

NEEDLE & SPECIAL DUTY VALVES

Brass Fittings

Needle Valves

Typical Applications

Instrumentation, Hydraulic, and Pneumatic systems.

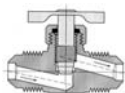

Advantages

Metal-to-Metal seat, with fine thread screw down, enables valves to seat positively, adjust easily and hold to any amount of flow up to capacity of the valve.

Pressure

150 psi maximum. (Does not include plastic tubing)

Material

Brass bodies and steel handles, except where noted. POLYLINE® valves have brass bodies and brass handles.

Used With

Copper, aluminum, steel and plastic tubing where applicable. When using POLYLINE® valves, use aluminum and copper tubing with brass sleeve only. Plastic tubing may be used with either brass or plastic sleeve.

Temperature Range

-65°F to +250°F (-53°C to + 121°C). POLYLINE® Valves -40°F to +150°F (-40°C to +66°C) with plastic sleeve. (Refer to tubing temperature range.)

Conformance

Designed for automotive and industrial use. Not intended for natural gas, LPG, nuclear or aircraft applications.

Assembly Instructions

Install with the pressure against the seat. Inspection of a straight valve discloses one opening to be higher than the other. Pressure should always be directed against the seat in angle valves, not the stem threads.

Female Pipe



FPT	Part No.	Price /Each
1/8 x1/8	68750	\$6.57
1/4 x1/4	68751	9.52

Compression Angle



Tube O.D.	MPT	Part No.	Price /Each
3/16	1/8	68752	\$11.36
1/4	1/8	68753	5.28
1/4	1/4	68754	10.02
5/16	1/8	68755	10.14
5/16	1/4	68756	19.03
3/8	1/8	68757	6.11
3/8	1/4	68758	12.90

Female to Male Pipe



FPT	MPT	Part No.	Price /Each
1/8	1/8	68759	\$6.24
1/4	1/4	68760	11.92

Compression Straightway



Tube O.D.	MPT	Part No.	Price /Each
1/4	1/8	68762	\$8.02
1/4	1/4	68763	9.82
5/16	1/8	68764	10.75
3/8	1/4	68765	14.10

SAE 45° Flare Angle



Tube O.D.	MPT	Part No.	Price /Each
1/4	1/8	68766	\$5.49
5/16	1/4	68769	11.73
3/8	1/4	68770	10.25

SAE 45° Flare Straightway



Tube O.D.	MPT	Part No.	Price /Each
1/4	1/8	68771	\$7.10
1/4	1/4	68772	9.52
3/8	1/4	68774	12.77

SAE 45° Flare Double



Tube O.D.	Part No.	Price /Each
1/4x1/4	67334	\$10.10
3/8 x3/8	68775	8.50

Male Pipe (Double)



MPT	Part No.	Price /Each
1/8x1/8	68776	\$10.19
1/4x1/4	68777	9.05

Compression Double



Tube O.D.	Part No.	Price /Each
1/4 x1/4	68778	\$4.70
5/16 x5/16	68779	10.07
3/8 x3/8	68780	5.84

E.T.N. | Weatherhead

Needle Valves

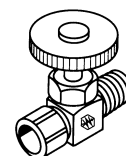

Polyline Rightway

Tube O.D.	MPT	Vendor No.	Part No.	Price /Each
1/4	1/8	A690P	440740-131280	\$24.65
3/8	1/4	A6760P	440741-131280	28.88

Polyline Angle

Tube O.D.	MPT	Vendor No.	Part No.	Price /Each
1/4	1/8	A555P	440742-131280	\$16.61
1/4	1/4	A556P	440743-131280	17.02
3/8	1/4	A6860P	440744-131280	19.78

Special Duty Valves

Information

- Forged bodies, solid bottom, spring loaded top
- Neoprene "O" ring seal, steel cad plated handles
- Individually ground plugs
- Valves are packed with a non-drying, synthetic grease
- Use with copper, aluminum, steel and plastic tubing where applicable
- Used for low pressure applications where a quick on and off operation is desired with a generous flow.
- 30 psi
- Solid bottom and O-ring seal prevents leakage to and from the atmosphere
- Use on fuel oil, water, gas, air and LP gas
- Compression valves are complete with nuts and sleeves

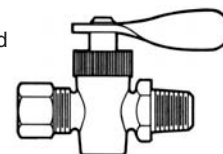

Flare to MPT

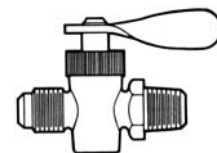

Tube O.D.	MPT	Part No.	Price /Each
1/4	1/8	69978	\$17.61
1/4	1/4	69979	17.00
3/8	1/4	69990	18.28
3/8	3/8	69982	20.09

SPECIAL DUTY, SPECIAL SERVICE VALVES & DRAIN COCKS

Brass Fittings

Special Duty Valves Cont.

Flare to Flare

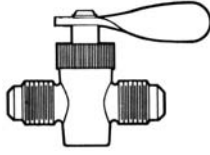

Tube O.D.	Part No.	Price /Each
1/4 x1/4	68791	\$17.79
3/8 x3/8	68793	24.24
1/2 x1/2	68794	16.38

FPT to FPT

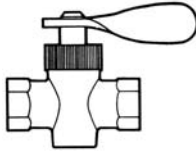

FPT	Part No.	Price /Each
1/4 x1/4	68796	\$23.68
3/8 x3/8	68797	18.76

MPT to MPT

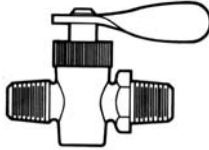

MPT	Part No.	Price /Each
1/8 x1/8	68798	\$16.81
1/4 x1/4	68799	24.47

FPT to MPT

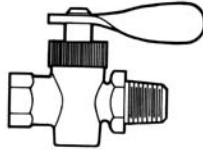

FPT	MPT	Part No.	Price /Each
1/8	1/8	68801	\$22.86
1/4	1/4	68802	20.09
3/8	3/8	68803	25.35

Special Service Valves and Drain Cocks

Drain Cocks and Drain Valves have been a specialty with Weatherhead since 1919. Millions are in use. The original design has proved so efficient that it is still the leader with most original equipment manufacturers. The metal-to-metal seat requires only hand tightening to assure positive leak-proof performance.

Material

Brass bodies and steel handles, except where noted.

Pressure

150 psi maximum (does not include hose or plastic tubing).

Used With

Copper, aluminum, steel, hose and plastic tubing where applicable.

Temperature

-65°F to +250°F (-53°C to +121°C). (Refer to tubing temperature range.)

Conformance

Designed for automotive or industrial use. Not intended for natural gas, LPG, nuclear or aircraft applications, except as noted.

Internal Seat



MPT	Part No.	Price /Each
1/8	68848	\$6.12
1/4	68849	5.64
3/8	68850	7.11

Angle Bib Drain

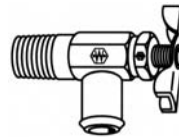

MPT	Hose I.D.	Part No.	Price /Each
1/4	3/8	68851	\$5.81

Internal Seat Drain Valve



MPT	Part No.	Price /Each
1/8	68852	\$3.95
1/4	0467777	3.44
3/8	0467778	4.24

FAT•N | Weatherhead

External Seat



MPT	Part No.	Price /Each
1/8	68853	\$2.13
1/4	68854	1.73
3/8	68855	5.42
1/2	0449032	11.88

Draincock



MPT	Part No.	Price /Each
1/8	68856	\$9.87
1/4	68857	15.24

Ground Plug and Multiple Shut-Offs

Material

Brass bodies and handles.

Pressure

30 psi working pressure, except where noted.

Used With

Copper, aluminum, steel and plastic tubing where applicable.

Temperature

-40°F to +250°F (-53°C to +121°C). (Refer to tubing temperature range.)

Conformance

Designed for automotive or industrial use. Not intended for natural gas, LPG, nuclear or aircraft applications, except as noted.

Note

Ground Plug Drains and Shut-Offs use a universal lubricant satisfactory for use with most common fluids. However, the lubricant may wash out at higher pressures or with some exotic fluids.

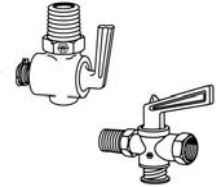

Ground Plug Drain



MPT	Part No.	Price /Each
1/8	69960	\$10.09
1/4	69961	10.53
3/8	69962	17.42
1/2	69963	18.93

4-Way Multiple Shut-Off



FPT	Part No.	Price /Each
1/4 1.37" STEM	68804	\$27.29

3-Way Multiple Shut-Off



FPT	Part No.	Price /Each
1/8	68806	\$32.63
1/4	68807	35.07
3/8	68808	41.80

BRASS VALVES & BRASS MINI-BARB FITTINGS

Ground Plug Valves

MPT to MPT

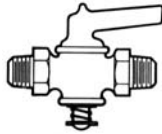

MPT	Part No.	Price /Each
1/8 x1/8	68826	\$12.63
1/4 x1/4	68827	10.65
3/8 x3/8	68828	16.53

Female Pipe



FPT	Part No.	Price /Each
1/8 x1/8	69964	\$11.34
1/4 x1/4	69965	13.52
3/8 x3/8	69966	18.96

Male to Female Pipe



MPT	FPT	Part No.	Price /Each
1/8	1/8	68829	\$8.65
1/4	1/4	68830	8.98
3/8	3/8	68831	18.88

Special Service Drain and Truck Valves

Barrel Faucet Self-Closing, Zinc Body, Nylon Seat

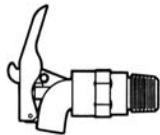

MPT	Part No.	Price /Each
3/4	68864	\$15.43

Pipe To Hose Shut-Off Brass Body

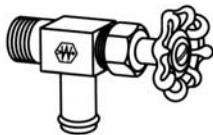

Tube O.D.	MPT	Part No.	Price /Each
3/8	3/8	69970	\$15.51
1/2	3/8	69240	16.91
5/8	3/8	69971	14.91
3/4	3/8	69241	24.41
3/4	1/2	69973	29.57

Oil Tank Valve MPT to FPT

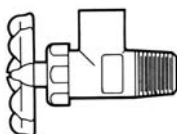

Tube O.D.	MPT	FPT	Part No.	Price /Each
1/2	1/2	3/8	68871	\$17.43

A-align Needle Valves

A-align to A-align

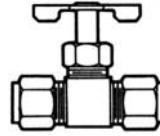

Tube O.D.	Part No.	Price /Each
1/4	68877	\$6.29

Brass Mini-Barb Fittings

FAT-N | Weatherhead

Union Tee

The Mini-Barb is a clampless connector of Polyethylene tubing.

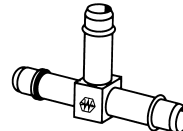

Tube O.D.	Vendor No.	Part No.	Price /Each
1/4	1064X4	441325-131280	\$2.08
3/8 x3/8 x1/4	1064X6X6X4	441326-131280	2.25
3/8	1064X6	441327-131280	2.03
3/8 x1/2 x3/8	1064X6X8X6	441328-131280	3.01
1/2 x1/2 x1/4	1064X8X8X4	441329-131280	3.40
1/2 x1/2 x3/8	1064X8X8X6	441330-131280	2.97
1/2	1064X8	441331-131280	3.41

Plug

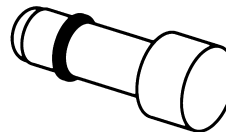

Tube O.D.	Vendor No.	Part No.	Price /Each
1/4	1073X4	441344-131280	\$0.66
3/8	1073X6	441345-131280	1.83

Male Branch Tee

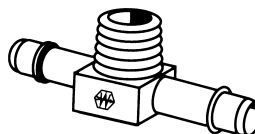

Tube O.D.	MPT	Vendor No.	Part No.	Price /Each
1/4	1/8	1072X4	441338-131280	\$2.49
3/8	1/8	1072X6X2	441339-131280	2.52
3/8	1/4	1072X6	441340-131280	3.98

Union

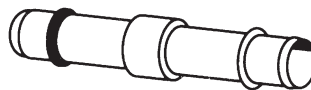

Tube O.D.	Vendor No.	Part No.	Price /Each
1/4 x3/16*	1062X4X3	441348-131280	\$1.80
1/4	1062X4	441349-131280	1.11
1/4	1062X4L	441350-131280	1.58
3/8 x1/4	1062X6X4	441351-131280	1.66
3/8	1062X6	441352-131280	0.68
1/2 x3/8	1062X8X6	441354-131280	2.01
1/2	1062X8	441355-131280	2.14

*No barb on 3/16" end.
L = Long Union

Female Branch Tee

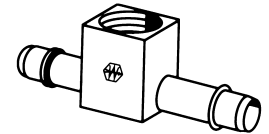

Tube O.D.	FPT	Vendor No.	Part No.	Price /Each
1/4	1/8	1077X4	441342-131280	\$3.33

Male Connector

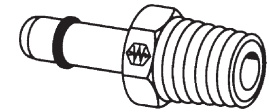

Tube O.D.	MPT	Vendor No.	Part No.	Price /Each
5/32	1/8	1068X2.5X2	441358-131280	\$1.85
1/4	1/16	1068X4X1	441359-131280	1.01
1/4	1/8	1068X4	441360-131280	0.90
1/4	1/4	1068X4X4	441361-131280	1.70
3/8	1/8	1068X6X2	441362-131280	1.12
3/8	1/4	1068X6	441363-131280	2.11
1/2	3/8	1068X8	441365-131280	3.59

90° Male Elbow

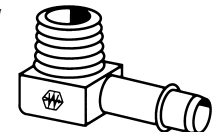

Tube O.D.	MPT	Vendor No.	Part No.	Price /Each
1/4	1/16	1069X4X1	441377-131280	\$1.99
1/4	1/8	1069X4	441378-131280	1.50
1/4	1/4	1069X4X4	441379-131280	2.13
3/8	1/8	1069X6X2	441380-131280	2.25
3/8	1/4	1069X6	441381-131280	3.24
1/2	3/8	1069X8	441382-131280	6.41

Female Connector

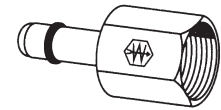

Tube O.D.	FPT	Vendor No.	Part No.	Price /Each
1/4	1/8	1066X4	441367-131280	\$1.94
1/4	1/4	1066X4X4	441368-131280	4.13

90° Female Elbow

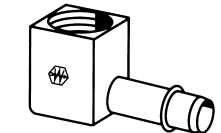

Tube O.D.	FPT	Vendor No.	Part No.	Price /Each
1/4	1/8	1070X4	441384-131280	\$2.26
3/8	1/8	1070X6X2	441386-131280	3.36
3/8	1/4	1070X6	441387-131280	3.82

Compression Connector

Compression size is 1/4" O.D.

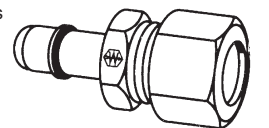

Tube O.D.	Vendor No.	Part No.	Price /Each
3/16 x1/4 comp*	1078X3X4	441372-131280	\$2.38
1/4 x1/4 comp	1078X4X4	441373-131280	2.50

*No Barb on 3/16" end.

BRASS MINI-BARB FITTINGS, BRASS HOSE BARB FITTINGS

Brass Mini-Barb Fittings Cont.

F.T.N. | Weatherhead

90° Union Elbow

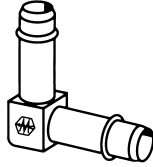

Tube O.D.	Vendor No.	Part No.	Price /Each
1/4	1065X4	441389-131280	\$1.63
3/8	1065X6	441390-131280	1.89
1/2	1065X8	441391-131280	2.80

Bulkhead Union

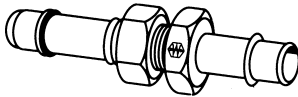

Tube O.D.	Thread	Vendor No.	Part No.	Price /Each
1/4	5/16-24	1074X4	441374-131280	\$4.03
3/8	3/8-24	1074X6	441375-131280	5.73

Bulkhead Comp Connector

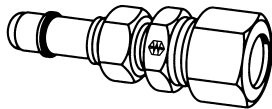

Tube O.D.	Vendor No.	Part No.	Price /Each
1/4 x1/4	1067X4X4	441392-131280	\$3.95

Brass Hose Barb Fittings

Male Hose Barb

Brass hose barb fittings are designed for use with a hose clamp or a crimped ferrule on low-pressure air lines.

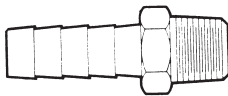

Hose I.D.	MPT	Part No.	Price /Each
1/8	1/8	69917	\$0.75
3/16	1/8	69918	0.79
3/16	1/4	69919	0.97
1/4	1/8	69920	0.71
1/4	1/4	69921	0.88
1/4	3/8	69922	1.22
1/4	1/2	69923	3.12
5/16	1/8	69924	0.88
5/16	1/4	69925	0.83
5/16	3/8	69926	1.48
3/8	1/8	69927	1.21
3/8	1/4	69928	1.33
3/8	3/8	69929	1.33
3/8	1/2	69930	1.99
3/8	3/4	69977	2.75
1/2	1/4	69931	1.21
1/2	3/8	69932	1.60
1/2	1/2	69933	1.87
1/2	3/4	69934	3.16
5/8	3/8	69935	1.56
5/8	1/2	69936	2.00
5/8	3/4	69937	2.74
3/4	1/2	69938	2.17
3/4	3/4	69939	2.94
1	3/4	69940	3.76
1	1	69941	7.09

Female Hose Barb

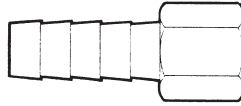

Hose I.D.	FPT	Part No.	Price /Each
1/8	1/8	68668	\$1.46
3/8	1/8	68669	1.27
1/4	1/8	68670	1.02
1/4	1/4	68671	1.26
1/4	3/8	68672	1.78
5/16	1/8	68673	2.70
5/16	1/4	68674	1.64
5/16	3/8	68675	3.48
3/8	1/8	68676	1.46
3/8	1/4	68677	1.27
3/8	3/8	68678	1.69
3/8	1/2	68679	2.18
1/2	3/8	68680	2.14
1/2	1/2	68681	2.40

Female Hose Barb to Swivel Ball End Female Straight Mechanical (FSM)

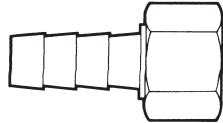

Hose I.D.	Thread	Part No.	Price /Each
1/8	1/8 FSM	68682	\$1.52
3/16	1/8 FSM	68683	1.71
3/16	1/4 FSM	68684	1.66
1/4	1/4 FSM	68685	1.26
5/16	1/4 FSM	68686	1.27
3/8	1/4 FSM	68687	1.29
3/8	3/8 FSM	68688	1.73
1/2	3/8 FSM	68689	2.28
1/2	1/2 FSM	68690	2.77
3/4	3/4 FSM	68691	4.29

Male Swivel Ball Adapter

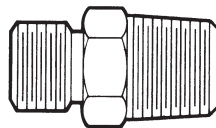

MPT	Part No.	Price /Each
1/4 x1/8	68692	\$1.41
1/4 x1/4	68693	0.94
3/8 x1/4	68694	2.66
3/8 x3/8	68695	4.34
1/2 x3/8	68696	3.09
1/2 x1/2	68697	4.59

Use with 209AS

Hose Barb Female Swivel 37° JIC Flare

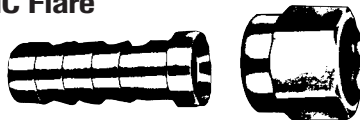

MPT	Part No.	Price /Each
3/16 x3/16	67176	\$1.15
1/4 x3/8	67177	1.20
5/16 x3/8	67178	1.41
3/8 x3/8	67179	1.74

Hose Barb to Female 45° SAE Flare Swivel

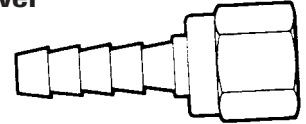

Hose I.D.	Tube O.D.	Part No.	Price /Each
1/4	1/4	68698	\$1.35
1/4	3/8	68699	1.77
5/16	5/16	68700	2.41
3/8	3/8	68701	1.72
3/8	1/2	68702	3.15
1/2	1/2	68703	2.75

Brass Ferrules and Hand Crimping Vice For Crimping Industrial Air Hose

Brass Ferrules for use with hose barb fittings. Make sure ferrule closely matches hose O.D. Use the 5229-CV500 crimper.

Hose I.D.	Part No.	Price /Each
.525	03093716542	\$0.30
.562	03093716543	0.37
.593	03093716544	0.40
.625	03093716545	0.40
.656	03093716546	0.42
.687	03093716547	0.50
.718	03093716548	0.56
.750	03093716549	0.57
.900	0429999	0.43
1.110	0429998	0.49

Heavy-Duty Ferrule Crimping Machine

- Low cost, portable and self-contained
- Allows for fitting/repairing most popular hose sizes without changing dies
- One-hand operation, rugged
- Instant die selection
- Crimps 1/4" to 3/8" I.D. hose in 1 or 2 braid design
- Furnished with mounting holes for permanent installations or use it as a portable tool for hose assembly in the field



Part No.	Price /Each
5229-CV500	\$164.37

Hose Barb to Male 45° SAE Flare

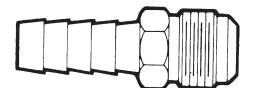

Hose I.D.	Tube O.D.	Part No.	Price /Each
1/4	1/4	68715	\$1.43
1/4	3/8	68717	1.23
5/16	5/16	68718	4.50
3/8	3/8	68719	1.37
1/2	1/2	68720	3.16

BRASS HOSE BARB FITTINGS, BRASS BARB-TITE/PUSH-ON HOSE FITTINGS

Brass Hose Barb Fittings Cont.

Hose Mender/Splicer

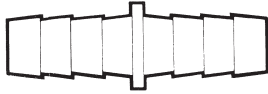

Hose I.D.	Part No.	Price /Each
3/16	69985	\$1.09
1/4"	69986	1.26
5/16	69987	1.28
3/8"	69988	1.29
1/2"	69989	1.63
5/8"	67196	2.11
3/4"	67197	3.14

45° Male Elbow

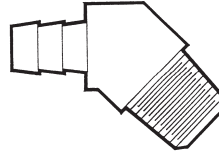

Hose I.D.	MPT	Part No.	Price /Each
1/4	1/8	68704	\$3.05
5/16	1/8	68705	2.21
5/16	1/4	68706	2.60
3/8	1/8	68707	3.49
3/8	1/4	68708	3.03
3/8	3/8	68709	3.84
1/2	1/4	68710	3.98
1/2	3/8	68711	3.61
5/8	3/8	68712	3.54

Male 90° Elbow Hose Barb



Hose I.D.	Thread	Part No.	Price /Each
1/4	1/8	69942	\$1.96
1/4	1/4	69943	2.64
5/16	1/4	69944	2.13
3/8	1/4	69945	2.13
3/8	3/8	69946	2.56
1/2	3/8	69947	3.54
5/8	3/8	69948	2.87
5/8	1/2	69949	3.82

F.T.N | Weatherhead

Brass Barb-Tite/Push-on Hose Fittings

The Barb-Tite/Grip-On hose fitting is designed for use with low-pressure air, lube or oil lines. The fitting pushes directly onto the hose. No clamp, ferrule or crimping is needed. Other trade names for this hose fitting include: Push-Lok, Lock-On and Socketless. Parts are reusable.

How to Order: To order the premium domestic line of Weatherhead, use the 13-digit part numbers. The 5-digit part numbers are a mix of other companies that make up our utility line.

Weatherhead compatible hoses are H100, H101, H201 and H332.

Male Pipe (Rigid)

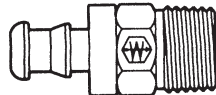

Hose I.D.	MPT	Vendor No.	Weatherhead		Utility	
			Part No.	Price /Each	Part No.	Price /Each
1/4	1/8-27	10004B-102	441462-131280	\$1.38	68523	\$1.02
1/4	1/4-18	10004B-104	441463-131280	1.48	68524	1.15
5/16	1/8-27	10005B-102	441464-131280	2.59	67198	1.65
5/16	1/4-18	10005B-104	441465-131280	2.86	67199	1.57
3/8	1/8-27	10006B-102	441466-131280	2.25	67268	1.39
3/8	1/4-18	10006B-104	441467-131280	2.25	68525	1.90
3/8	3/8-18	10006B-106	441468-131280	2.31	68526	1.61
1/2	3/8-18	10008B-106	441469-131280	3.99	68527	3.90
1/2	1/2-14	10008B-108	441470-131280	4.19	68528	4.15
5/8	1/2-14	10010B-108	441471-131280	4.65	68529	4.52
3/4	3/4-14	10012B-112	441472-131280	7.94	68530	7.62

SAE 45° Male Flare (Rigid)

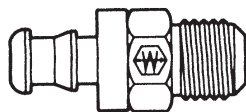

Hose I.D.	Tube O.D.	Vendor No.	Weatherhead		Utility	
			Part No.	Price /Each	Part No.	Price /Each
1/4	1/4	10004B-304	441473-131280	\$1.76	68531	\$1.49
1/4	5/16	10004B-305	441474-131280	2.59	68532	2.16
5/16	5/16	10005B-305	441475-131280	3.32		
3/8	3/8	10006B-306	441476-131280	2.76	68533	1.82
1/2	1/2				68534	7.61

90° Male Pipe (Rigid Elbow)

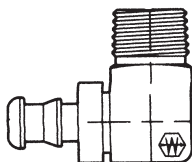

Hose I.D.	MPT	Vendor No.	Part No.	Price /Each
5/16	1/8	10005B-C02	441477-131280	\$5.15
5/16	1/4	10005B-C04	441478-131280	5.04
3/8	1/8	10006B-C02	441479-131280	6.21
3/8	1/4	10006B-C04	441480-131280	4.69

Inverted Male (Swivel)

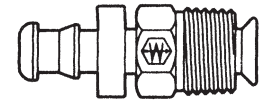

Hose I.D.	Tube O.D.	No.	Weatherhead		Utility	
			Vendor Part No.	Price /Each	Part No.	Price /Each
1/4	3/16	10004B-B03	441481-131280	\$2.53	68545	\$2.25
1/4	1/4	10004B-B04	441482-131280	2.41	68546	1.65
1/4	5/16	10004B-B05	441483-131280	2.64	68547	2.52
5/16	1/4	10005B-B04	441484-131280	4.42		
5/16	5/16	10005B-B05	441485-131280	3.07		
5/16	3/8	10005B-B06	441486-131280	5.83		
3/8	5/16	10006B-B05	441487-131280	2.76		
3/8	3/8	10006B-B06	441488-131280	3.15	68548	3.09
1/2	1/2	10008B-B08	441489-131280	3.81		
5/8	5/8				68550	5.98

Inverted Female (Rigid)

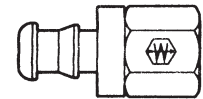

Hose I.D.	Tube Size	Vendor No.	Weatherhead		Utility	
			Part No.	Price /Each	Part No.	Price /Each
1/4	3/16	10004B-A03	441490-131280	\$1.98	68551	\$1.75
1/4	1/4	10004B-A04	441491-131280	1.84	68552	1.62
1/4	5/16	10004B-A05	441492-131280	2.05	68553	1.87
5/16	5/16	10005B-A05	441493-131280	4.56		
3/8	5/16	10006B-A05	441494-131280	2.89	67269	2.84
3/8	3/8	10006B-A06	441495-131280	2.54	67270	1.95
1/2	1/2	10008B-A08	441496-131280	5.56	68554	4.75

SAE 37° (JIC) Female (Swivel)

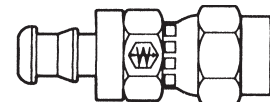

Hose I.D.	Tube O.D.	Vendor No.	Weatherhead		Utility	
			Part No.	Price /Each	Part No.	Price /Each
1/4	1/4	10004B-604	441497-131280	\$2.99		
5/16	5/16	10005B-605	441498-131280	3.72		
3/8	3/8	10006B-606	441499-131280	4.75	68557	4.75
1/2	1/2	10008B-608	441500-131280	6.10		
5/8	5/8	10010B-610	441501-131280	9.86		
3/4	3/4	10012B-612	441502-131280	14.25	68558	8.55

BRASS BARB-TITE, SS HOSE BARB & BRASS COMPRESSION

Brass Barb-Tite/Push-on Hose Fittings Cont.

F.T.N | Weatherhead

SAE 45° Flare Female (Swivel)

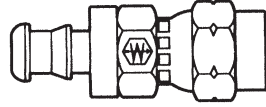

Hose I.D.	Tube O.D.	Weatherhead		Utility		
		Vendor No.	Part No.	Price /Each	Part No.	Price /Each
3/8	3/8	10006B-406	441507-131280	2.98	68555	\$2.70
3/4	3/4	10012B-412	441510-131280	8.97	68556	7.55

45°/37° Female Dual Angle Seal (Swivel)

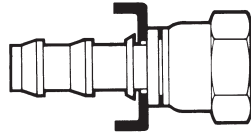

Hose I.D.	Thread	Part No.	Price /Each
1/4	1/4	68559	\$1.32
1/4	5/16	68560	6.06
1/2	1/2	68561	2.57
5/8	5/8	68562	5.60
5/16	5/16	65316	1.73
3/8	1/2	65317	3.86

Stainless Steel Hose Barbs

Straight Beaded Hose Stem

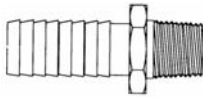

Tube O.D.	NPTF	Part No.	Price /Each
1/4	1/4	426199	\$21.16
3/8	1/4	426200	18.92
3/8	3/8	426201	21.96
1/2	1/4	426202	14.73
1/2	3/8	426203	18.42
1/2	1/2	426204	29.55
3/4	3/4	426205	45.03
1	1	426206	55.72

Brass Compression Fittings (Standard)

F.T.N | Weatherhead

Tube Support For Plastic Tubing

Compression fittings are popular 3-piece flareless fittings for metal and plastic tubing. Insert is only used on PT200 and PT2400, not PT230 (Nylon 6/6).



Tube O.D.	Vendor No.	Weatherhead		Utility	
		Part No.	Price /Each	Part No.	Price /Each
1/4*	2030X44	440364-131280	\$0.09		
1/4**	2030X4	440365-131280	0.42	67898	0.12
5/16	2030X5	440366-131280	0.32	67899	0.44
3/8	2030X6	440367-131280	0.36	67900	0.29
1/2	2030X8	440368-131280	0.45	67901	0.45
5/8	2030X10	440369-131280	0.87	67902	0.84
3/4	2030X12	440370-131280	1.23		

*For tubing with .170 I.D. / .040 wall thickness

**For tubing with .126 I.D. / .062 wall thickness

10-14

Female Pipe (Swivel)

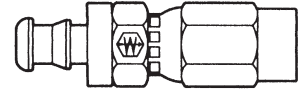

Hose I.D.	FPT	Vendor No.	Part No.	Price /Each
1/4	1/4	10004B-254	441511-131280	\$5.10
3/8	3/8	10006B-256	441512-131280	9.55
1/2	1/2	10008B-258	441513-131280	11.13

Rigid Tube Shank (Straight)

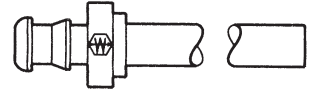

Hose I.D.	Tube O.D.	Vendor No.	Weatherhead		Utility	
			Part No.	Price /Each	Part No.	Price /Each
1/4	3/16	10004B-X03	441514-131280	\$1.98	68535	\$1.77
1/4	1/4	10004B-X05	441515-131280	2.29	68536	2.16
1/4	5/16	10004B-X05	441516-131280	2.74	68537	1.95
3/8	3/8	10006B-X06	441518-131280	3.15	68538	2.78
1/2	1/2				68539	2.05

Hose Mender/Splicer



Hose I.D.	Vendor No.	Weatherhead		Utility	
		Part No.	Price /Each	Part No.	Price /Each
1/4	10004B-Y04	441519-131280	\$2.67	68541	\$1.77
5/16	10005B-Y05	441520-131280	3.76	67271	1.45
3/8	10006B-Y06	441521-131280	3.16	68542	2.74
1/2	10008B-Y08	441522-131280	4.89	68543	4.53
5/8				68544	6.40

Compression Sleeve



Tube O.D.	Vendor No.	Weatherhead		Utility	
		Part No.	Price /Each	Part No.	Price /Each
1/8	60X2	440372-131280	\$0.11	69670	\$0.09
3/16	60X3	440373-131280	0.12	69671	0.09
1/4	60X4	440374-131280	0.11	69672	0.11
5/16	60X5	440375-131280	0.09	69673	0.08
3/8	60x6	440376-131280	0.12	69674	0.12
7/16	60X7	440377-131280	0.29	69675	0.27
1/2	60X8	440378-131280	0.21	69676	0.19
1/2*				69514	0.44
5/8	60X10	440379-131280	0.49	69677	0.23
5/8*				69515	0.46
3/4				69678	0.49
7/8*				69679	0.61

*Wide Sleeve

Delrin Sleeve



Tube O.D.	Part No.	Price /Each
1/4	68263	\$0.07
5/16	68264	0.25
3/8	68265	0.13
1/2	68266	0.23
5/8	68267	0.41

Nut



Tube O.D.	Vendor No.	WH		Utility	
		Part No.	Price /Each	Part No.	Price /Each
1/8	61X2	440382-131280	\$0.17	69680	\$0.16
3/16	61X3	440383-131280	0.22	69681	0.21
1/4	61X4	440384-131280	0.25	69682	0.25
5/16	61X5	440385-131280	0.29	69683	0.27
3/8	61X6	440386-131280	0.29	69684	0.30
7/16	61X7	440387-131280	0.92	69685	0.79
1/2	61X8	440388-131280	0.59	69686	0.55
1/2*				69516	1.38
5/8	61X10	440389-131280	0.66	69687	0.65
3/4				69688	1.77
7/8				69689	1.54

*Heavy Pattern

Long Nut

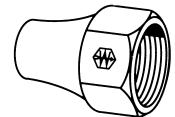

Tube O.D.	Vendor No.	Weatherhead		Utility	
		Part No.	Price /Each	Part No.	Price /Each
1/8				68268	\$0.87
3/16				68269	0.65
1/4	1611X4	440392-131280	0.48	68270	0.46
5/16				68271	1.44
3/8				68272	0.65
1/2				68273	2.95
5/8				68274	2.02
3/4				68275	6.97

BRASS COMPRESSION FITTINGS

Brass Compression Fittings (Standard)

FAT-N | Weatherhead

Bulkhead Nut

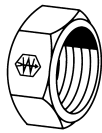

Tube O.D.	Vendor No.	Part No.	Price /Each
1/4	0102X4	440399-131280	\$0.96
5/16	0102X5	440400-131280	1.29
3/8	0102X6	440401-131280	1.11
1/2	0102X8	440402-131280	1.50

Use with 74 series Bulkhead Union.

Union

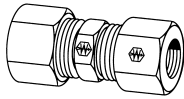

Tube O.D.	Weatherhead		Utility	
	Vendor No.	Part No.	Price /Each	Price /Each
1/8	62X2	440403-131280	\$1.19	69690
3/16	62X3	440404-131280	1.19	69691
1/4 x1/8*				69389
1/4 x3/16*				69390
1/4	62X4	440405-131280	0.93	69692
5/16 x1/4*				69391
5/16	62X5	440406-131280	1.65	69693
3/8 x1/4*				69392
3/8 x5/16*				69393
3/8	62X6	440407-131280	1.52	69694
7/16				69695
1/2 x3/8*				69394
1/2	62X8	440409-131280	3.21	69696
5/8 x3/8*				69395
5/8 x1/2*				69700
5/8	62X10	440410-131280	4.94	69697
3/4				69698
7/8				69699

*Reducing Union

Bulkhead Union

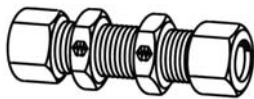

Tube O.D.	Weatherhead		Utility	
	Vendor No.	Part No.	Price /Each	Price /Each
1/4	74X4	440412-131280	\$4.90	68276
3/8				68277

Male Ball Check Connector

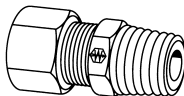

Tube O.D.	MPT	Weatherhead		Utility	
		Vendor No.	Part No.	Price /Each	Price /Each
1/8	1/8			68284	\$13.57
1/4	1/8	63X4	440417-131280	3.92	68285
3/8	1/4	63X6	440419-131280	4.15	68286

Male Connector

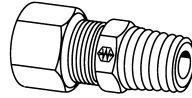

Tube O.D.	MPT	Weatherhead		Utility	
		Vendor No.	Part No.	Price /Each	Price /Each
1/8	1/8	68X2	440420-131280	\$0.83	69701
3/16	1/8	68X3	440421-131280	0.79	69702
3/16	1/4				69703
1/4	1/8	68X4	440422-131280	0.69	69704
1/4	1/4	68X4X4	440423-131280	0.95	69705
1/4	3/8				69706
1/4	1/2				69707
5/16	1/8	68X5	440424-131280	0.84	69708
5/16	1/4	68X5X4	440425-131280	1.15	69709
5/16	3/8				69710
3/8	1/8	68X6X2	440426-131280	1.15	69712
3/8	1/4	68X6	440427-131280	1.15	69713
3/8	3/8	68X6X6	440428-131280	1.63	69714
3/8	1/2	68X6X8	440429-131280	2.03	69715
3/8	3/4				69716
7/16	1/4				69717
7/16	3/8				69518
1/2	1/4	68X8X4	440431-131280	2.60	69718
1/2	3/8	68X8	440432-131280	2.00	69719
1/2	1/2	68X8X8	440433-131280	1.72	69720
1/2	3/4				69721
5/8	3/8				69722
5/8	1/2	68X10	440434-131280	3.58	69723
5/8	3/4				69724
3/4	1/2				69725
3/4	3/4				69726
7/8	1/2				69727
7/8	3/4				69728

Female Connector

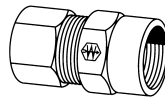

Tube O.D.	FPT	Weatherhead		Utility	
		Vendor No.	Part No.	Price /Each	Price /Each
1/8	1/8	66X2	440438-131280	\$1.04	69478
3/16	1/8	66X3	440439-131280	1.23	69479
3/16	1/4				69480
1/4	1/8	66X4	440440-131280	1.00	69481
1/4	1/4	66X4X4	440441-131280	1.67	69482
1/4	3/8				69483
1/4	1/2				69484
5/16	1/8	66X5	440442-131280	0.95	69485
5/16	1/4				69486
3/8	1/8	66X6X2	440444-131280	1.34	69488
3/8	1/4	66X6	440445-131280	1.93	69489
3/8	3/8				69490
3/8	1/2				69491
1/2	1/4				69492
1/2	3/8	66X8	440446-131280	2.70	69493
1/2	1/2				69494
1/2	3/4				67361
5/8	3/8				69495
5/8	1/2				69496
5/8	3/4				69497
3/4	1/2				67362
3/4	3/4				69498
7/8	3/4				69499

Male Connector (Drilled Through)

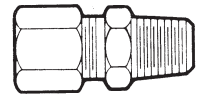

Tube O.D.	MPT	Part No.	Price /Each
1/4	1/8	68291	\$0.75
1/4	1/4	68292	0.93
3/8	3/8	68295	1.31
3/8	1/2	68296	1.68
1/2	3/8	68297	1.55
1/2	1/2	68298	1.68
5/8	1/2	68299	2.35
5/8	3/4	68300	5.57

45° Male Elbow

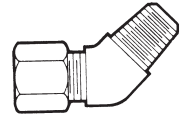

Tube O.D.	MPT	Part No.	Price /Each
3/16	1/8	69771	\$15.49
1/4	1/8	69772	3.83
5/16	1/8	69773	7.99
5/16	1/4	69774	7.62
3/8	1/4	69775	4.63
1/2	3/8	69776	7.04
5/8	1/2	69777	12.32

Union Elbow

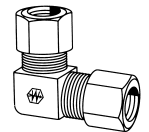

Tube O.D.	Weatherhead		Utility	
	Vendor No.	Part No.	Price /Each	Price /Each
1/8				69379
3/16				69380
1/4	65X4	440449-131280	1.92	69381
5/16	65X5	440450-131280	3.24	69383
3/8 x1/4				69384
3/8	65X6	440451-131280	2.54	69512
1/2	65X8	440452-131280	4.00	69513
5/8				69386
5/8 x3/8				67363
3/4				69387
7/8				69388

BRASS COMPRESSION FITTINGS & SELF-ALIGN BRASS FITTINGS

Brass Compression Fittings (Standard) Cont.

F.T.N | Weatherhead

90° Male Elbow

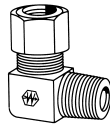

		Weatherhead		Utility		
Tube O.D.	MPT	Vendor No.	Part No.	Price /Each	Part No.	Price /Each
1/8	1/16	69X2X1	440453-131280	\$4.08		
1/8	1/8	69X2	440454-131280	1.44	69730	1.39
3/16	1/8	69X3	440455-131280	1.29	69731	1.29
3/16	1/8 F				69370	2.33
3/16	1/4				69732	2.44
1/4	1/8	69X4	440456-131280	1.27	69733	1.25
1/4	1/8 F				69371	2.25
1/4	1/4	69X4X4	440457-131280	1.55	69734	1.50
1/4	1/4 F				69372	2.53
1/4	3/8				69735	2.53
1/4	1/2				69736	4.75
5/16	1/8	69X5	440458-131280	1.85	69737	1.80
5/16	1/8 F				69373	2.46
5/16	1/4	69X5X4	440459-131280	1.92	69738	1.86
5/16	1/4 F				69374	2.79
5/16	3/8				69739	3.30
3/8	1/8	69X6X2	440460-131280	1.76	69741	1.70
3/8	1/4	69X6	440461-131280	1.94	69742	1.89
3/8	1/4 F				69375	3.18
3/8	3/8	69X6X6	440462-131280	2.10	69743	1.99
3/8	3/8 F				69376	3.24
3/8	1/2	69X6X8	440463-131280	2.95	69744	2.91
7/16	1/4				69377	4.77
1/2	1/4	69X8X4	440465-131280	3.33	69745	3.25
1/2	3/8	69X8	440466-131280	2.89	69746	2.85
1/2	1/2	69X8X8	440467-131280	3.99	69747	3.66
1/2	3/4				69748	5.67
5/8	3/8				69749	4.71
5/8	1/2	69X10	440468-131280	4.79	69750	4.65
5/8	3/4				69751	8.59
3/4	1/2				69752	8.05
3/4	3/4				69753	9.01
7/8	3/4				69754	12.25

F = Forged

90° Female Elbow

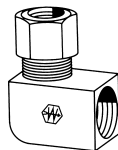

Tube O.D.	FPT	Part No.	Price /Each
1/8	1/8	68324	\$4.98
3/16	1/8	68325	2.99
1/4	1/8	68326	1.66
1/4	1/4	68327	2.77
5/16	1/8	68328	3.27
5/16	1/4	68329	3.71
3/8	1/8	68330	3.25
3/8	1/4	68331	2.84
3/8	3/8	68332	3.25
3/8	1/2	68333	3.39
1/2	1/4	68334	6.63
1/2	3/8	68335	4.54
1/2	1/2	68336	4.91
1/2	3/4	68337	7.95
5/8	1/2	68338	6.06
5/8	3/4	68339	9.25
3/4	1/2	68340	15.22
3/4	3/4	68341	19.29

Street/Adapter Tee

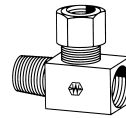

Tube O.D.	MPT	FPT	Part No.	Price /Each
1/8	1/8	1/8	68354	\$6.35
3/16	1/8	1/8	68355	3.65
1/4	1/8	1/8	68356	3.84
1/4	1/4	1/4	68357	6.53
3/8	1/4	1/4	68358	7.34

Union Tee

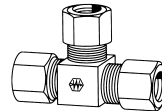

		Weatherhead		Utility	
Tube O.D.	Vendor No.	Part No.	Price /Each	Part No.	Price /Each
1/8				69660	\$4.27
3/16	64X3	440481-131280	3.12	69661	3.07
1/4	64X4	440482-131280	3.53	69662	2.81
1/4 F				69396	3.84
5/16	64X5	440483-131280	3.74	69663	3.70
3/8 x1/4				69397	5.69
3/8	64X6	440484-131280	4.33	69664	2.90
3/8 F				69398	4.40
1/2	64X8	440485-131280	5.51	69665	4.97
5/8				69666	7.14
3/4				69667	18.62

F = Forged

Male Run Tee

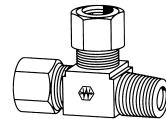

		Weatherhead		Utility		
Tube O.D.	MPT	Vendor No.	Part No.	Price /Each	Part No.	Price /Each
1/8	1/8			68342		\$3.12
3/16	1/8	71X3	440486-131280	2.66	68343	2.66
1/4	1/8	71X4	440487-131280	2.95	68344	2.79
1/4	1/4				68345	3.50
1/16	1/8				68346	4.13
3/8	1/8				68347	4.10
3/8	1/4	71X6	440490-131280	3.65	68348	3.59
3/8	3/8				68349	4.49
1/2	3/8				68350	6.57
1/2	1/2				68351	9.38
3/4	1/2				68353	23.06

Male Branch Tee

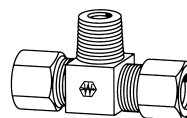

		Weatherhead		Utility		
Tube O.D.	Vendor No.	Part No.	Price /Each	Part No.	Price /Each	
1/8	1/8			69756	\$6.04	
3/16	1/8			69757	3.01	
1/4	1/8	72X4	440493-131280	2.95	69758	2.88
1/4	1/4	72X4x 4x 4	440494-131280	3.29	69759	3.15
5/16	1/8	72 x 5	440495-131280	3.45	69760	3.39
5/16	1/4			69761	3.60	
3/8	1/8			69762	4.53	
3/8	1/4	72X6	440496-131280	3.51	69763	3.45
3/8	3/8			69764	4.49	
1/2	3/8	72 x 8	440497-131280	7.96	69766	5.43
1/2	1/2			69767	7.45	
5/8	1/2			69768	8.65	
3/4	1/2			69769	24.44	
3/4	3/4			69755	23.92	

Control Nut



Tube O.D.	Part No.	Price /Each
1/4	68359	\$1.60

Self-Align Brass Fittings

Used with aluminum, copper and plastic tubing. Plastic tubing, except for PT2300 and TP160 requires 2030x insert. Not recommended for steel tubing. Should include the tube support 2030x.

Nut with Captive Sleeve

Please Note: Utility Align Nuts come assembled with brass sleeve. Weatherhead nuts/sleeves must be ordered separately. Self-Align fittings are 3-piece compression-style flareless fittings used with metal or plastic tubing. Compression and Self-Align fittings differ only in nut and sleeve; bodies are interchangeable.

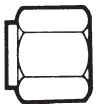

Tube O.D.	Part No.	Price /Each
1/8	67890	\$1.12
3/16	67891	1.10
1/4	67892	1.10
5/16	67893	1.34
3/8	67894	1.42
1/2	67895	1.49
5/8	67896	17.25
3/4	67897	5.31

Sleeve



Tube O.D.	Vendor No.	Part No.	Price /Each
1/8	601X2	440498-131280	\$0.23
3/16	601X3	440499-131280	0.17
1/4	601X4	440500-131280	0.19
5/16	601X5	440501-131280	0.20
3/8	601X6	440502-131280	0.29
1/2	601X8	440503-131280	0.61
5/8	601X10	440504-131280	1.13
3/4	601X12	440505-131280	1.29
1	601X16	440506-131280	1.90

Nut



Tube O.D.	Vendor No.	Part No.	Price /Each
1/8	611X2	440507-131280	\$0.22
3/16	611X3	440508-131280	0.24
1/4	611X4	440509-131280	0.39
5/16	611X5	440510-131280	0.38
3/8	611X6	440511-131280	0.47
1/2	611X8	440512-131280	0.95
5/8	611X10	440513-131280	2.66
3/4	611X12	440514-131280	3.41

SELF-ALIGN BRASS FITTINGS

Self-Align Brass Fittings Cont.

F.T.N. | Weatherhead Long Nut

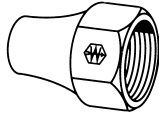

Tube O.D.	Part No.	Price /Each
3/16	68269	\$0.65
1/4	68270	0.46
5/16	68271	1.44
3/8	68272	0.65
1/2	68273	2.95
5/8	68274	2.02
3/4	68275	6.97

Bulkhead Nut

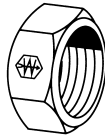

Tube O.D.	Vendor No.	Part No.	Price /Each
1/4	0102X4	440399-131280	\$0.96
5/16	0102X5	440400-131280	1.29
3/8	0102X6	440401-131280	1.11
1/2	0102X8	440402-131280	1.50

Use on 741 Bulkhead Unions (this page)

Union

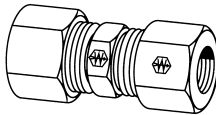

Tube O.D.	Vendor No.	Weatherhead		Utility	
		Part No.	Price /Each	Part No.	Price /Each
1/8	621X2	440523-131280	\$1.43	67903	\$1.39
3/16	621X3	440524-131280	1.95	67904	1.93
1/4	621X4	440525-131280	1.65	67905	1.61
5/16	621X5	440526-131280	2.49	67906	2.45
3/8	621X6	440527-131280	1.99	67907	1.98
1/2	621X8	440528-131280	2.98	67908	2.95
5/8	621X10	440529-131280	11.71	67909	3.89

Bulkhead Union

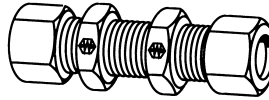

Tube O.D.	Vendor No.	Weatherhead		Utility	
		Part No.	Price /Each	Part No.	Price /Each
1/4	741X4	440531-131280	\$6.79	67910	\$6.79
3/8				67911	8.53

Male Connector

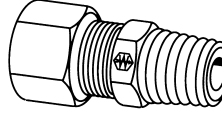

Tube O.D.	MPT	Vendor No.	Weatherhead		Utility	
			Part No.	Price /Each	Part No.	Price /Each
1/8	1/16	681X2X1	440535-131280	\$2.01		
1/8	1/8	681X2	440536-131280	0.96	67947	0.91
3/16	1/8	681X3	440537-131280	1.15	67948	1.05
1/4	1/8	681X4	440539-131280	0.98	67949	0.96
1/4	1/4	681X4X4	440540-131280	1.19	67950	1.15
5/16	1/8	681X5	440541-131280	1.39	67951	1.37
5/16	1/4	681X5X4	440542-131280	1.55	67952	1.55
3/8	1/8	681X6X2	440543-131280	1.25	67953	1.24
3/8	1/4	681X6	440544-131280	1.47	67954	1.44
3/8	3/8	681X6X6	440545-131280	2.26	67955	1.81
3/8	1/2	681X6X8	440546-131280	3.46	67956	2.29
1/2	1/4	681X8X4	440547-131280	3.65		
1/2	3/8	681X8	440548-131280	3.07	67957	2.23
1/2	1/2	681X8X8	440549-131280	2.15	67958	2.10
5/8	1/2	681X10	440550-131280	2.69	67960	2.49

Male Ball Check Connector

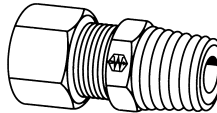

Tube O.D.	MPT	Vendor No.	Part No.	Price /Each
3/8	1/4	631X6	440557-131280	\$5.37

Female Connector

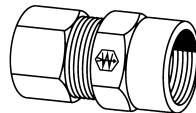

Tube O.D.	FPT	Vendor No.	Weatherhead		Utility	
			Part No.	Price /Each	Part No.	Price /Each
1/8	1/8	661X2	440558-131280	\$1.58	67934	\$1.54
3/16	1/8	661X3	440559-131280	1.99		
1/4	1/8	661X4	440560-131280	1.55	67936	1.09
1/4	1/4	661X4X4	440561-131280	1.79	67937	1.65
5/16	1/8	661X5	440562-131280	3.15		
3/8	1/8	661X6X2	440564-131280	2.33		
3/8	1/4	661X6	440565-131280	1.59	67941	1.57
1/2	3/8	661X8	440566-131280	3.74	67942	2.74
1/2	1/2				67943	2.91

90° Union Elbow

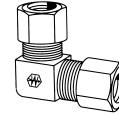

Tube O.D.	Vendor No.	Weatherhead		Utility	
		Part No.	Price /Each	Part No.	Price /Each
1/4	651X4	440569-131280	2.19	67930	\$2.15
3/8	651X6	440571-131280	3.99	67931	2.74
1/2				67932	4.36

90° Male Elbow

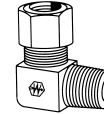

Tube O.D.	MPT	Vendor No.	Weatherhead		Utility	
			Part No.	Price /Each	Part No.	Price /Each
1/8	1/16	691X2X1	440573-131280	\$3.54		
1/8	1/8	691X2	440574-131280	1.48	67966	1.44
3/16	1/8	691X3	440575-131280	2.01	67967	1.66
1/4	1/8	691X4	440576-131280	1.59	67968	1.58
1/4	1/4	691X4X4	440577-131280	1.85	67969	1.83
5/16	1/8	691X5	440578-131280	2.31	67970	2.17
5/16	1/4	691X5X4	440579-131280	2.87	67971	2.29
3/8	1/8	691X6X2	440580-131280	2.17	67972	2.09
3/8	1/4	691X6	440581-131280	2.19	67973	2.15
3/8	3/8	691X6X6	440582-131280	2.25	67974	2.21
3/8	1/2	691X6X8	440583-131280	3.19	67975	3.15
1/2	1/4	691X8X4	440584-131280	6.62		
1/2	3/8	691X8	440585-131280	3.65	67976	3.63
1/2	1/2	691X8X8	440586-131280	3.95	67977	3.90
5/8	1/2	691X10	440587-131280	10.64	67978	5.44

90° Female Elbow

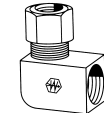

Tube O.D.	FPT	Part No.	Price /Each
1/4	1/8	67979	\$2.28
1/4	1/4	67980	3.25
3/8	1/4	67982	3.25
1/2	3/8	67983	4.81

45° Male Elbow

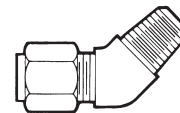

Tube O.D.	MPT	Part No.	Price /Each
1/4	3/8	67962	\$4.35
5/16	1/8	67963	6.22
3/8	1/4	67964	3.56

SELF-ALIGN BRASS FITTINGS & BRASS POLYLINE FITTINGS

Self-Align Brass Fittings Cont.

F.T.N | Weatherhead

Union Tee

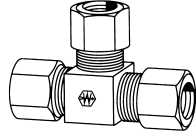

Tube O.D.	Vendor No.	Weatherhead		Utility	
		Part No.	Price /Each	Part No.	Price /Each
1/8				67921	\$5.44
3/16	641X3	440597-131280	4.45	67922	4.45
1/4	641X4	440598-131280	2.95	67923	2.93
5/16	641X5	440599-131280	3.81	67924	3.63
3/8	641X6	440600-131280	3.75	67925	3.68
1/2	641X8	440601-131280	6.24	67926	5.66

Male Run Tee

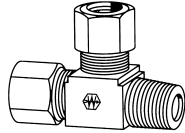

Tube O.D.	MPT	Vendor No.	Weatherhead		Utility	
			Part No.	Price /Each	Part No.	Price /Each
3/16	1/8	711X3	440602-131280	\$4.33		
1/4	1/8	711X4	440603-131280	3.12	67986	2.99
3/8	1/4	711X6	440606-131280	5.03	67988	4.19

Male Branch Tee

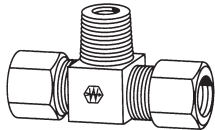

Tube O.D.	MPT	Vendor No.	Weatherhead		Utility	
			Part No.	Price /Each	Part No.	Price /Each
1/4	1/8	721X4	440609-131280	\$3.92	67990	\$3.25
1/4	1/4	721X4X4X4	440610-131280	5.73		
3/8	1/4	721X6	440612-131280	3.49	67992	3.46
1/2	3/8	721X8	440613-131280	6.55	67993	6.50
1/2	1/2				67994	7.56

Brass Polyline Fittings

Plastic Sleeve

Polyline flareless fittings are used with plastic tubing. Anderson's cross is the Poly-Fit; Parker's cross is the Poly-Tite; Standard sleeve is plastic. Note: Wall thickness of tube should be considered with the 1/4" O.D. tube size. The standard wall thickness in the 1/4" size is .040 and uses suffix of X4. Example (1262X4). The .062 wall thickness is shown as suffix X46 (1262X46). When buying tubing, standard wall thickness is also .040 and carries the Weatherhead Part Number PT24044. The 1/4" tubing with a wall of .040 outsells (10:1) the 1/4" with .062 wall. The tube fittings for .040 outsells .062 significantly.

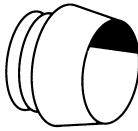

Tube O.D.	Vendor No.	Weatherhead		Utility	
		Part No.	Price /Each	Part No.	Price /Each
1/4	1260X4	440618-131280	\$0.13	68361	\$0.13
5/16	1260X5	440619-131280	0.18	68362	0.15
3/8	1260X6	440620-131280	0.12	68363	0.12
1/2	1260X8	440621-131280	0.31	68364	0.21

Brass Sleeve



Tube O.D.	Part No.	Price /Each
1/8	68365	\$0.81
1/4	68366	0.40
3/8	68368	2.39

Brass Nut (No Sleeve)



Tube O.D.	Vendor No.	Weatherhead		Utility	
		Part No.	Price /Each	Part No.	Price /Each
1/8	1261X2	440628-131280	\$0.74	68370	\$0.72
3/16	1261X3	440629-131280	0.57		
1/4	1261X4	440630-131280	0.49	68371	0.74
5/16				68372	0.74
3/8	1261X6	440632-131280	0.52	68373	0.75
1/2				68374	0.81

Brass Nut (Plastic Sleeve Assembly)

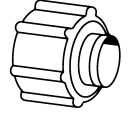

Tube O.D.	Vendor No.	Weatherhead		Utility	
		Part No.	Price /Each	Part No.	Price /Each
1/4	1261X4A	440634-131280	\$0.59	68375	\$0.59
5/16				68376	0.92
3/8	1261X6A	440636-131280	0.61	68377	0.58

Brass Nut (Brass Sleeve Assembly)

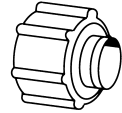

Tube O.D.	Part No.	Price /Each
1/8	68379	\$1.00
1/4	68380	0.97
3/8	68382	2.83
1/2	68383	1.01

Reducing Union

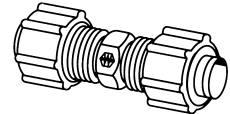

Tube O.D.	Part No.	Price /Each
3/8 x 1/4	68384	\$4.14

Union

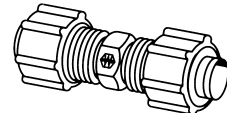

Tube O.D.	Vendor No.	Weatherhead		Utility	
		Part No.	Price /Each	Part No.	Price /Each
1/8				69822	\$3.34
1/4	1262X4	440651-131280	2.95	69785	2.88
5/16				69786	6.32
3/8	1262X6	440653-131280	3.00	69787	2.94
1/2				69788	7.34

Self-Align® to Polyline Union

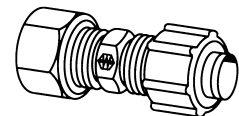

Tube O.D.	Part No.	Price /Each
1/4	69823	\$1.86

BRASS POLYLINE FITTINGS

Compression Fittings

Brass Polylines Fittings Cont.

F.T.N | Weatherhead

Bulkhead Union

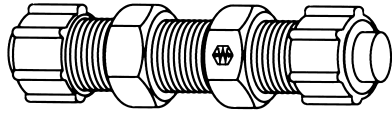

Tube O.D.	Part No.	Price /Each
1/4	68412	\$7.34
3/8	68413	7.40
1/2	68414	10.84

Female Connector

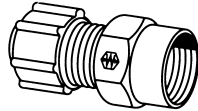

Tube O.D.	FPT	Weatherhead		Utility		
		Vendor No.	Part No.	Price /Each	Part No.	Price /Each
1/8	1/8	1266X2	440664-131280	\$2.17	68390	\$2.10
1/4	1/8	1266X4	440666-131280	1.70	68391	1.65
1/4	1/4	1266X4X4	440667-131280	2.60	68392	3.36
5/16	1/8				68393	4.23
3/8	1/4	1266X6	440671-131280	3.19	68394	2.89
1/2	3/8				68395	4.61

Male Connector

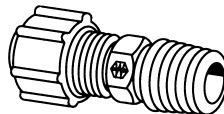

Tube O.D.	MPT	Weatherhead		Utility		
		Vendor No.	Part No.	Price /Each	Part No.	Price /Each
1/8	1/8			69800	\$1.93	
1/8	10-32			69798	3.72	
1/4	10-32			69799	4.64	
1/4	1/16	1268X4X1	440679-131280	4.12		
1/4	1/8	1268X4	440680-131280	1.55	69790	1.49
1/4	1/4	1268X4X4	440681-131280	1.79	69791	1.75
1/4	3/8			69801	4.36	
5/16	1/8			69792	3.54	
5/16	1/4			69793	2.59	
3/8	1/8	1268X6X2	440685-131280	1.88	69796	1.79
3/8	1/4	1268X6	440686-131280	2.18	69794	2.12
3/8	3/8	1268X6X6	440687-131280	2.33	69795	2.33
1/2	3/8	1268X8	440689-131280	3.65	69797	3.17

Male Run Tee

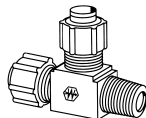

Tube O.D.	MPT	Part No.	Price /Each
1/4	1/8	68397	\$3.97
1/4	1/4	68398	4.52
5/16	1/8	68399	6.12
3/8	1/4	68400	4.46
1/2	3/8	68401	10.05

Female Branch Tee

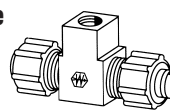

Tube O.D.	FPT	Part No.	Price /Each
1/4	1/4	68410	\$14.09
1/4	3/8	68411	9.89

Male Branch Tee

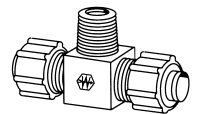

Tube O.D.	MPT	Part No.	Price /Each
1/8	1/8	68402	\$7.13
1/4	1/8	68403	4.26
1/4	1/4	68404	6.06
5/16	1/8	68405	7.20
3/8	1/8	68406	9.89
3/8	1/4	68407	5.78
1/2	3/8	68408	11.65

90° Female Elbow

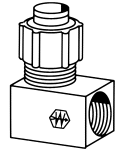

Tube O.D.	FPT	Weatherhead		Utility		
		Vendor No.	Part No.	Price /Each	Part No.	Price /Each
1/8	1/8				69803	\$11.66
1/4	1/8	1270X4	440694-131280	3.99	69815	2.60
1/4	1/4	1270X4X4	440695-131280	4.25	69816	4.19
3/8	1/4				69817	3.91
1/2	3/8				69820	6.99

90° Male Elbow

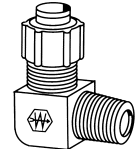

Tube O.D.	MPT	Weatherhead		Utility		
		Vendor No.	Part No.	Price /Each	Part No.	Price /Each
1/8	1/8				69814	\$2.59
1/4	1/16	1269X4X1	440703-131280	4.48		
1/4	1/8	1269X4	440704-131280	1.62	69804	1.59
1/4	1/4	1269X4X4	440705-131280	1.79	69805	1.75
1/4	3/8	1269X4X6	440707-131280	3.65	69802	3.59
5/16	1/8				69806	3.37
3/8	1/8	1269X6X2	440710-131280	2.36	69813	2.35
3/8	1/4	1269X6	440711-131280	3.12	69808	2.65
3/8	3/8	1269X6X6	440712-131280	3.29	69809	3.25
1/2	3/8				69811	5.23

Union Tee

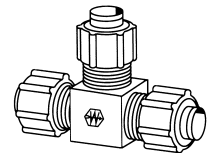

Tube O.D.	Weatherhead		Utility		
	Vendor No.	Part No.	Price /Each	Part No.	Price /Each
1/8				68385	\$9.10
1/4	1264X4	440718-131280	4.19	68386	3.99
5/16				68387	6.80
3/8	1264X6	440721-131280	5.81	68388	5.75
1/2				68389	7.94

NYLON MOLDED & STAINLESS STEEL COMPRESSION FITTINGS

Nylon Molded Compression Fittings

EATON | Weatherhead

Male Connector



Tube O.D.	Pipe Thread	Part No.	Vendor No.	Price /EA
1/8"	1/8"	0443227	1568X2	\$0.85
1/4"	1/8"	0443236	1568X4	0.85
1/4"	1/4"	0443237	1568X4X4	0.94
1/4"	3/8"	0443238	1568X4X6G	1.07
5/16"	1/8"	0443256	1568X5	1.01
5/16"	1/4"	0443257	1568X5X4	1.12
3/8"	1/8"	0443274	1568X6X2	1.19
3/8"	1/4"	0443273	1568X6	1.04
3/8"	3/8"	0443275	1568X6X6	1.17
3/8"	1/2"	0443276	1568X6X8	1.68
1/2"	1/4"	0443295	1568X8X4	2.14
1/2"	3/8"	0443294	1568X8	1.68
1/2"	1/2"	0443296	1568X8X8	1.50
5/8"	1/2"	0443312	1568X10G	1.98
3/4"	3/4"	0443317	1568X12X12G	4.05

Female Connector



Tube O.D.	Pipe Thread	Part No.	Vendor No.	Price /EA
1/4"	1/8"	0443234	1566X4	\$1.08
1/4"	1/4"	0443235	1566X4X4	1.07
3/8"	1/4"	0443270	1566X6	1.71
3/8"	3/8"	0443271	1566X6X6	1.68
3/8"	1/2"	0443272	1566X6X8	1.91
1/2"	3/8"	0443292	1566X8	1.57
1/2"	1/2"	0443293	1566X8X8	1.68

Union Connector



Tube O.D.	Pipe Thread	Part No.	Vendor No.	Price /EA
1/4"	7/16"	0443231	1562X4	\$1.34
5/16"	1/2"	0443253	1562X5	1.69
3/8"	5/8"	0443267	1562X6	1.90
1/2"	3/4"	0443290	1562X8	2.44
5/8"	7/8"	0443309	1562X10G	3.76
3/4"	1-1/16-20	0443315	1562X12G	5.96

Bulkhead Union



Tube O.D.	Part No.	Vendor No.	Price /EA
1/4"	0443248	1574X4	\$2.01
3/8"	0443285	1574X6	2.52
1/2"	0443306	1574X8	3.49
3/4"	0443318	1574X12G	7.24

Male Elbow



Tube O.D.	Pipe Thread	Part No.	Vendor No.	Price /EA
1/4"	1/8"	0443239	1569X4	\$1.51
1/4"	1/4"	0443240	1569X4X4	1.43
1/4"	3/8"	0443241	1569X4X6	1.49
3/8"	1/4"	0443277	1569X6	1.56
3/8"	3/8"	0443278	1569X6X6	1.58
1/2"	1/4"	0443298	1569X8X4G	2.37
1/2"	3/8"	0443297	1569X8	2.18
1/2"	1/2"	0443299	1569X8X8	2.26
5/8"	1/2"	0443313	1569X10G	3.11

Female Elbow



Tube O.D.	Pipe Thread	Part No.	Vendor No.	Price /EA
1/4"	1/4"	0443243	1570X4X4	\$1.68
3/8"	3/8"	0443280	1570X6X6	2.55

Union Elbow



Tube O.D.	Part No.	Vendor No.	Price /EA
1/4"	0443233	1564X8	\$1.55
3/8"	0443269	1565X6	2.55

Male Branch Tee



Tube O.D.	Pipe Thread	Part No.	Vendor No.	Price /EA
1/4"	1/8"	0443246	1572X4	\$2.11
1/4"	1/4"	0443247	1572X4X4X4	1.96
3/8"	3/8"	0443284	1572X6X6X6	2.71
1/2"	1/2"	0443305	1572X8X8X8	3.65

Union Tee



Tube O.D.	Part No.	Vendor No.	Price /EA
1/8"	0443226	1564X2	\$2.23
1/4"	0443232	1564X4	1.96
3/8"	0443268	1564X6	3.17
1/2"	0443291	1564X8	3.49

Male Run Tee



Tube O.D.	Pipe Thread	Part No.	Vendor No.	Price /EA
1/4"	1/4"	0443245	1571X4X4X4	\$1.96
1/2"	1/2"	0443303	1571X8X8X8G	4.37

Compression Nut



Tube O.D.	Part No.	Vendor No.	Price /EA
1/4"	0443230	1561X4G	\$0.59
3/8"	0443266	1561X6G	1.13
1/2"	0443289	1561X8G	1.05

Insert



Tube O.D.	Part No.	Vendor No.	Price /EA
1/4"	0443249	1584X4	\$0.13
5/16"	0443263	1584X5	0.20
3/8"	0443286	1584X6	0.19
1/2"	0443307	1584X8	0.32

Cap Nut



Tube O.D.	Part No.	Vendor No.	Price /EA
1/8"	0443225	1529X2	\$0.50
1/4"	0443229	1529X4	0.54
3/8"	0443265	1529X6	0.63
1/2"	0443288	1529X8	0.85

Bulkhead Nut



Tube O.D.	Part No.	Vendor No.	Price /EA
1/4"	0443228	1502X4	\$0.24
3/8"	0443264	1502X6	0.36

Stainless Steel Compression Fittings



Tube O.D.	Part No.	Price /Each
1/4"	425010	\$3.60
3/8"	425012	4.02
1/2"	425013	5.90
5/8"	425014	12.67

Nut



Tube O.D.	Part No.	Price /Each
1/8"	425019	\$3.49
3/16"	425020	3.60
1/4"	425021	3.04
5/16"	425022	5.96
3/8"	425023	4.32
1/2"	425024	4.24
5/8"	425025	9.65
3/4"	425026	13.91
1"	425028	20.54
1-1/4"	425029	44.75

Tube Sleeve Ferrule

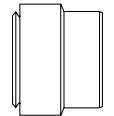

Tube O.D.	Part No.	Price /Each
1/8"	425032	\$2.68
3/16"	425033	3.01
1/4"	425034	1.80
5/16"	425035	3.02
3/8"	425036	3.12
1/2"	425037	2.53
5/8"	425038	4.22
3/4"	425039	6.47
1"	425041	12.10
1-1/4"	425042	21.95

Straight Tube Union

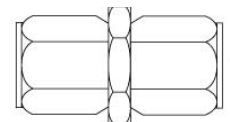

Tube O.D.	Part No.	Price /Each
1/8"	425045	\$28.93
3/16"	425046	21.16
1/4"	425047	13.13
5/16"	425048	26.25
3/8 x 1/4"	425049	24.64
3/8"	425050	16.88
1/2"	425051	26.78
3/4"	425053	72.03
1"	425055	106.93

Compression Fittings

STAINLESS STEEL COMPRESSION FITTINGS

Stainless Steel Compression Fittings Cont.

Straight Tube Union Large Hex

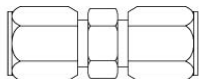

Tube O.D.	Part No.	Price /Each
1/4	425059	\$22.50
3/8	425060	23.84
1/2 x3/8	425061	43.92
1/2	425062	42.85

Male Straight Adapter

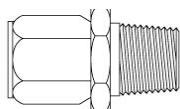

Tube O.D.	MPT	Part No.	Price /Each
1/8	1/8	425066	\$13.39
1/4	1/4	425067	11.79
1/4	3/8	425068	14.73
1/4	1/2	425069	18.75
5/16	1/4	425070	14.63
3/8	1/8	425071	14.07
3/8	3/8	425072	13.83
3/8	1/2	425073	20.31
1/2	1/4	425074	18.70
1/2	1/2	425075	21.01
1/2	3/4	425076	38.84
5/8	3/4	425078	81.04
3/4	1/2	425079	51.42
3/4	3/4	425080	50.35
1	3/4	425081	79.91
1	1	425082	72.84
1-1/4	1-1/4	425083	253.26

Female Straight Adapter



Tube O.D.	FPT	Part No.	Price /Each
1/4	1/4	425087	\$14.20
3/8	3/8	425088	20.09
3/8	1/2	425089	30.00
1/2	1/4	425090	21.43
1/2	1/2	425091	35.62
3/4	3/4	425092	58.53
1	1	425093	96.40

90° Male Elbow

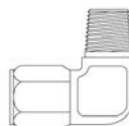

Tube O.D.	MPT	Part No.	Price /Each
1/4	1/4	425105	\$18.75
1/4	3/8	425106	38.03
5/16	1/4	425107	25.45
3/8	1/8	425108	24.21
3/8	3/8	425109	27.86
3/8	1/2	425110	39.64
1/2	1/4	425111	34.28
1/2	1/2	425112	42.85
1/2	3/4	425113	100.69
3/4	1/2	425115	160.18
3/4	3/4	425116	70.16
1	1	425118	123.83
1-1/4	1-1/4	425119	242.01

90° Female Elbow

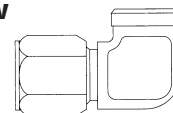

Tube O.D.	FPT	Part No.	Price /Each
1/4	1/8	425142	\$20.89
1/4	1/4	425143	27.59
3/8	3/8	425144	74.44
1/2	1/2	425146	55.16
3/4	3/4	425147	110.40

Male Side Tee

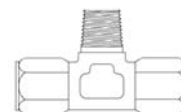

Tube O.D.	MPT	Part No.	Price /Each
1/4	1/8	425158	\$28.71
1/4	1/4	425159	34.28
3/8	1/4	425161	36.16
1/2	3/8	425162	105.80
1/2	1/2	425163	106.93

Tube Tee

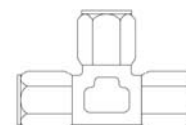

Tube O.D.	Part No.	Price /Each
1/4	425177	\$28.39
5/16	425178	52.91
3/8	425179	36.43
1/2	425180	58.64
3/4	425182	138.43

HOSE CRIMPING

- Fastenal can crimp low pressure air hose, or high pressure hydraulic hose (0-5,000 psi), 1/4" to 2" in diameter
- Whether you need 20 or 20,000 hose assemblies we have the capability to meet your needs
- Custom lettering or part numbers can be applied directly to your assembled hose
- Rush orders are made possible through our Emergency Hose Crimping Service
- Our factory trained technicians possess the knowledge and expertise to handle a wide range of crimping assignments



INSTRUMENTATION STYLE COMPRESSION FITTINGS

Instrumentation Style Compression Fittings



CBC-Lok™ Tube Fittings are fully interchangeable with tube fittings of Swagelok® and Parker A-Lok® fittings featuring double collet (ferrule) swaging action.

*Parker A-Lok® is a registered trademark of Parker Hannifin Corporation.
Swagelok® is a registered trademark of Swagelok Company.

How to Order Tylok® Tube Fittings

Tylok Tube Fittings (CBC-Lok™) are ordered as listed in this catalog by inserting the material code before the part number. Tylok Tube Fittings can be identified through the part number as to material, tube size, configuration, and thread connection. The part number describes a complete fitting assembly. Other part families may be available, but not listed in this catalog. Go to www.tylok.com for a list of all product families offered.

Tylok Tube Fittings are made in the USA.

Example: A stainless steel male connector, 1/2" tube size to a 1/2" male pipe is designated below...

SS - 8 - D MC - 8

Material **Chart 1** Tube OD **Chart 2** Style **Chart 3** Part Family **Chart 2** Odd End Size **Chart 2**

CHART 1 - MATERIAL

Designator	Material
B	Brass
SS	Stainless Steel

CHART 2 - TUBE O.D.

Designator	Tube O.D. or Hose I.D. (inches)	Pipe Thread (NPT)
1	1/16	1/16-27
2	1/8	1/8-27
3	3/16	
4	1/4	1/4-18
5	5/16	
6	3/8	3/8-18
8	1/2	1/2-14
10	5/8	
12	3/4	3/4-14
14	7/8	
16	1	1-11.5

CHART 3 - STYLE

Designator	Style
D	CBC-Lok™, Nut & 2 Ferrules

Male Connector



Tube Size	MPT	Stainless Steel					Brass				
		Part No.	CBC-LOK Ref. No.	Swagelok® Ref. No.	Parker A-Lok® Ref. No.	UOM /Each	Part No.	CBC-LOK Ref. No.	Swagelok® Ref. No.	Parker A-Lok® Ref. No.	UOM /Each
1/4"	1/8"	0426435	SS-4-DMC-2	SS-400-1-2	SS-4MSC2N	\$7.18	0426515	B-4-DMC-2	B-400-1-2	B-4MSC2N	\$2.59
1/4"	1/4"	0426436	SS-4-DMC-4	SS-400-1-4	SS-4MSC4N	7.45	0426516	B-4-DMC-4	B-400-1-4	B-4MSC4N	2.58
3/8"	1/4"	0426437	SS-6-DMC-4	SS-600-1-4	SS-6MSC4N	10.17	0426517	B-6-DMC-4	B-600-1-4	B-6MSC4N	3.11
3/8"	3/8"	0426438	SS-6-DMC-6	SS-600-1-6	SS-6MSC6N	11.46	0426518	B-6-DMC-6	B-600-1-6	B-6MSC6N	3.42
1/2"	1/4"	0426439	SS-8-DMC-4	SS-810-1-4	SS-8MSC4N	14.80	0426519	B-8-DMC-4	B-810-1-4	B-8MSC4N	5.54
1/2"	1/2"	0426440	SS-8-DMC-8	SS-810-1-8	SS-8MSC8N	17.08	0426520	B-8-DMC-8	B-810-1-8	B-8MSC8N	5.93
3/4"	3/4"	0426441	SS-12-DMC-12	SS-1210-1-12	SS-12MSC12N	26.04	0426521	B-12-DMC-12	B-1210-1-12	B-12MSC12N	8.26
1"	1"	0426442	SS-16-DMC-16	SS-1610-1-16	SS-16MSC16N	45.64	0426522	B-16-DMC-16	B-1610-1-16	B-16MSC16N	15.26

Union



Tube Size	Part No.	Stainless Steel				Brass				
		CBC-LOK Ref. No.	Swagelok® Ref. No.	Parker A-Lok® Ref. No.	UOM /Each	Part No.	CBC-LOK Ref. No.	Swagelok® Ref. No.	Parker A-Lok® Ref. No.	UOM /Each
1/16"	0426443	SS-1-DU	SS-100-6	SS-1SC1	\$16.65	0426523	B-1-DU	B-100-6	B-1SC1	\$4.67
1/8"	0426444	SS-2-DU	SS-200-6	SS-2SC2	11.64	0426524	B-2-DU	B-200-6	B-2SC2	3.67
3/16"	0426445	SS-3-DU	SS-300-6	SS-3SC3	10.62	0426525	B-3-DU	B-300-6	B-3SC3	3.55
1/4"	0426446	SS-4-DU	SS-400-6	SS-4SC4	11.48	0426526	B-4-DU	B-400-6	B-4SC4	3.01
5/16"	0426447	SS-5-DU	SS-500-6	SS-5SC5	12.95	0426527	B-5-DU	B-500-6	B-5SC5	4.06
3/8"	0426448	SS-6-DU	SS-600-6	SS-6SC6	16.50	0426528	B-6-DU	B-600-6	B-6SC6	4.31
1/2"	0426449	SS-8-DU	SS-810-6	SS-8SC8	24.50	0426529	B-8-DU	B-810-6	B-8SC8	6.90
5/8"	0426450	SS-10-DU	SS-1010-6	SS-10SC10	31.79	0426530	B-10-DU	B-1010-6	B-10SC10	9.98
3/4"	0426451	SS-12-DU	SS-1210-6	SS-12SC12	39.68	0426531	B-12-DU	B-1210-6	B-12SC12	11.92
7/8"	0426452	SS-14-DU	SS-1410-6	SS-14SC14	64.68	0426532	B-14-DU	B-1410-6	B-14SC14	19.20
1"	0426453	SS-16-DU	SS-1610-6	SS-16SC16	68.86	0426533	B-16-DU	B-1610-6	B-16SC16	21.50

INSTRUMENTATION STYLE COMPRESSION FITTINGS

Instrumentation Style Compression Fittings Cont.



Union Elbow

Tube Size	Part No.	Stainless Steel				Brass				
		CBC-LOK Ref No.	Swagelok® Ref. No.	Parker A-Lok® Ref. No.	UOM /Each	Part No.	CBC-LOK Ref No.	Swagelok® Ref. No.	Parker A-Lok® Ref. No.	UOM /Each
1/8"	0426454	SS-2-DELU-2	SS-200-9	SS-2EE2	\$15.60	0426534	B-2-DELU-2	B-200-9	B-2EE2	\$6.66
3/16"	0426455	SS-3-DELU-3	SS-300-9	SS-3EE3	15.56	0426535	B-3-DELU-3	B-300-9	B-3EE3	6.15
1/4"	0426456	SS-4-DELU-4	SS-400-9	SS-4EE4	16.76	0426536	B-4-DELU-4	B-400-9	B-4EE4	5.31
5/16"	0426457	SS-5-DELU-5	SS-500-9	SS-5EE5	17.89	0426537	B-5-DELU-5	B-500-9	B-5EE5	6.93
3/8"	0426458	SS-6-DELU-6	SS-600-9	SS-6EE6	20.46	0426538	B-6-DELU-6	B-600-9	B-6EE6	7.03
1/2"	0426459	SS-8-DELU-8	SS-810-9	SS-8EE8	33.65	0426539	B-8-DELU-8	B-810-9	B-8EE8	10.26
5/8"	0426460	SS-10-DELU-10	SS-1010-9	SS-10EE10	37.67	0426540	B-10-DELU-10	B-1210-9	B-12EE12	13.11
3/4"	0426461	SS-12-DELU-12	SS-1210-9	SS-12EE12	59.37	0426541	B-12-DELU-12	B-1210-9	B-12EE12	19.19
7/8"	0426462	SS-14-DELU-14	SS-1410-9	SS-14EE14	91.14	0426542	B-14-DELU-14	B-1410-9	B-14EE14	30.25
1"	0426463	SS-16-DELU-16	SS-1610-9	SS-16EE16	113.63	0426543	B-16-DELU-16	B-1610-9	B-16EE16	35.81



Male Elbow

Tube Size	MPT	Stainless Steel				Brass					
		Part No.	CBC-LOK Ref No.	Swagelok® Ref. No.	Parker A-Lok® Ref. No.	UOM /Each	Part No.	CBC-LOK Ref No.	Swagelok® Ref. No.	Parker A-Lok® Ref. No.	UOM /Each
1/4"	1/8"	0426464	SS-4-DME-2	SS-400-2-2	SS-4MSEL2N	\$13.17	0426544	B-4-DME-2	B-400-2-2	B-4MSEL2N	\$4.90
1/4"	1/4"	0426465	SS-4-DME-4	SS-400-2-4	SS-4MSEL4N	14.16	0426545	B-4-DME-4	B-600-2-4	B-6MSEL4N	5.27
3/8"	1/4"	0426466	SS-6-DME-4	SS-600-2-4	SS-6MSEL4N	17.60	0426546	B-6-DME-4	B-600-2-4	B-6MSEL4N	5.93
3/8"	3/8"	0426467	SS-6-DME-6	SS-600-2-6	SS-6MSEL6N	21.17	0426547	B-6-DME-6	B-600-2-6	B-6MSEL6N	6.80
3/8"	1/2"	0426468	SS-6-DME-8	SS-600-2-8	SS-6MSEL8N	27.23	0426548	B-6-DME-8	B-600-2-8	B-6MSEL8N	8.30
1/2"	1/2"	0426469	SS-8-DME-8	SS-810-2-8	SS-8MSEL8N	31.06	0426549	B-8-DME-8	B-810-2-8	B-8MSEL8N	8.38
3/4"	3/4"	0426470	SS-12-DME-12	SS-1210-2-12	SS-12MSEL12N	37.80	0426550	B-12-DME-12	B-1210-2-12	B-12MSEL12N	13.81
1"	1"	0426471	SS-16-DME-16	SS-1610-2-16	SS-16MSEL16N	73.67	0426551	B-16-DME-16	B-1610-2-16	B-16MSEL16N	27.03



Union Tee

Tube Size	Part No.	Stainless Steel				Brass				
		CBC-LOK Ref No.	Swagelok® Ref. No.	Parker A-Lok® Ref. No.	UOM Each	Part No.	CBC-LOK Ref No.	Swagelok® Ref. No.	Parker A-Lok® Ref. No.	UOM /Each
1/8"	0426472	SS-2-DTTT-2	SS-200-3	SS-2ET2	\$25.32	0426552	B-2-DTTT-2	B-200-3	B-2ET2	\$8.40
3/16"	0426473	SS-3-DTTT-3	SS-300-3	SS-3ET3	25.63	0426553	B-3-DTTT-3	B-300-3	B-3ET3	9.34
1/4"	0426474	SS-4-DTTT-4	SS-400-3	SS-4ET4	23.64	0426554	B-4-DTTT-4	B-400-3	B-4ET4	8.36
5/16"	0426475	SS-5-DTTT-5	SS-500-3	SS-5ET5	26.99	0426555	B-5-DTTT-5	B-500-3	B-5ET5	9.01
3/8"	0426476	SS-6-DTTT-6	SS-600-3	SS-6ET6	30.80	0426556	B-6-DTTT-6	B-600-3	B-6ET6	9.75
1/2"	0426477	SS-8-DTTT-8	SS-810-3	SS-8ET8	46.79	0426557	B-8-DTTT-8	B-810-3	B-8ET8	14.23
5/8"	0426478	SS-10-DTTT-10	SS-1010-3	SS-10ET10	54.67	0426558	B-10-DTTT-10	B-1010-3	B-10ET10	18.09
3/4"	0426479	SS-12-DTTT-12	SS-1210-3	SS-12ET12	69.96	0426559	B-12-DTTT-12	B-1210-3	B-12ET12	22.99
7/8"	0426480	SS-14-DTTT-14	SS-1410-3	SS-14ET14	129.58	0426560	B-14-DTTT-14	B-1410-3	B-14ET14	43.08
1"	0426481	SS-16-DTTT-16	SS-1610-3	SS-16ET16	149.95	0426561	B-16-DTTT-16	B-1610-3	B-16ET16	46.19

INSTRUMENTATION STYLE COMPRESSION FITTINGS

Instrumentation Style Compression Fittings Cont.



Compression Fittings

Front Collet



Tube Size	Stainless Steel					Brass				
	Part No.	CBC-LOK Ref No.	Swagelok® Ref. No.	Parker A-Lok® Ref. No.	UOM /Each	Part No.	CBC-LOK Ref No.	Swagelok® Ref. No.	Parker A-Lok® Ref. No.	UOM /Each
1/16"	0426482	SS-DFC-1	SS-103-1	SS-1FF1	\$2.18	0426562	B-DFC-1	B-103-1	B-1FF1	\$0.67
1/8"	0426483	SS-DFC-2	SS-203-1	SS-2FF2	1.41	0426563	B-DFC-2	B-203-1	B-2FF2	0.42
3/16"	0426484	SS-DFC-3	SS-303-1	SS-3FF3	1.39	0426564	B-DFC-3	B-303-1	B-3FF3	0.39
1/4"	0426485	SS-DFC-4	SS-403-1	SS-4FF4	1.20	0426565	B-DFC-4	B-403-1	B-4FF4	0.37
5/16"	0426486	SS-DFC-5	SS-503-1	SS-5FF5	1.37	0426566	B-DFC-5	B-503-1	B-5FF5	0.49
3/8"	0426487	SS-DFC-6	SS-603-1	SS-6FF6	1.40	0426567	B-DFC-6	B-603-1	B-6FF6	0.52
1/2"	0426488	SS-DFC-8	SS-813-1	SS-8FF8	2.00	0426568	B-DFC-8	B-813-1	B-8FF8	0.74
5/8"	0426489	SS-DFC-10	SS-1013-1	SS-10FF10	2.34	0426569	B-DFC-10	B-1013-1	B-10FF10	0.91
3/4"	0426490	SS-DFC-12	SS-1213-1	SS-12FF12	3.39	0426570	B-DFC-12	B-1213-1	B-12FF12	1.13
7/8"	0426491	SS-DFC-14	SS-1413-1	SS-14FF14	5.40	0426571	B-DFC-14	B-1413-1	B-14FF14	1.39
1"	0426492	SS-DFC-16	SS-1613-1	SS-16FF16	6.03	0426572	B-DFC-16	B-1613-1	B-16FF16	2.12

Nut

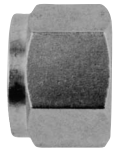

Tube Size	Stainless Steel					Brass				
	Part No.	CBC-LOK Ref No.	Swagelok® Ref. No.	Parker A-Lok® Ref. No.	UOM /Each	Part No.	CBC-LOK Ref No.	Swagelok® Ref. No.	Parker A-Lok® Ref. No.	UOM /Each
1/16"	0426493	SS-DN-1	SS-102-1	SS-NU1	\$3.79	0426573	B-DN-1	B-102-1	B-NU1	\$0.96
1/8"	0426494	SS-DN-2	SS-202-1	SS-NU2	2.44	0426574	B-DN-2	B-202-1	B-NU2	0.63
3/16"	0426495	SS-DN-3	SS-302-1	SS-NU3	2.19	0426575	B-DN-3	B-302-1	B-NU3	0.56
1/4"	0426496	SS-DN-4	SS-402-1	SS-NU4	2.16	0426576	B-DN-4	B-402-1	B-NU4	0.42
5/16"	0426497	SS-DN-5	SS-502-1	SS-NU5	2.29	0426577	B-DN-5	B-502-1	B-NU5	0.62
3/8"	0426498	SS-DN-6	SS-602-1	SS-NU6	3.00	0426578	B-DN-6	B-602-1	B-NU6	0.71
1/2"	0426499	SS-DN-8	SS-812-1	SS-NU8	4.99	0426579	B-DN-8	B-812-1	B-NU8	0.98
5/8"	0426500	SS-DN-10	SS-1012-1	SS-NU10	6.89	0426580	B-DN-10	B-1012-1	B-NU10	1.31
3/4"	0426501	SS-DN-12	SS-1212-1	SS-NU12	8.20	0426581	B-DN-12	B-1212-1	B-NU12	1.79
7/8"	0426502	SS-DN-14	SS-1412-1	SS-NU14	10.65	0426582	B-DN-14	B-1412-1	B-NU14	3.27
1"	0426503	SS-DN-16	SS-1612-1	SS-NU16	15.64	0426583	B-DN-16	B-1612-1	B-NU16	4.30

Rear Collet

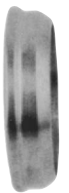

Tube Size	Stainless Steel					Brass				
	Part No.	CBC-LOK Ref No.	Swagelok® Ref. No.	Parker A-Lok® Ref. No.	UOM /Each	Part No.	CBC-LOK Ref No.	Swagelok® Ref. No.	Parker A-Lok® Ref. No.	UOM /Each
1/16"	0426504	SS-DRC-1	SS-104-1	SS-1BF1	\$2.06	0426584	B-DRC-1	B-104-1	B-1BF1	\$0.60
1/8"	0426505	SS-DRC-2	SS-204-1	SS-2BF2	1.30	0426585	B-DRC-2	B-204-1	B-2BF2	0.36
3/16"	0426506	SS-DRC-3	SS-304-1	SS-3BF3	1.23	0426586	B-DRC-3	B-304-1	B-3BF3	0.36
1/4"	0426507	SS-DRC-4	SS-404-1	SS-4BF4	1.02	0426587	B-DRC-4	B-404-1	B-4BF4	0.37
5/16"	0426508	SS-DRC-5	SS-504-1	SS-5BF5	1.29	0426588	B-DRC-5	B-504-1	B-5BF5	0.39
3/8"	0426509	SS-DRC-6	SS-604-1	SS-6BF6	1.34	0426589	B-DRC-6	B-604-1	B-6BF6	0.42
1/2"	0426510	SS-DRC-8	SS-814-1	SS-8BF8	1.83	0426590	B-DRC-8	B-814-1	B-8BF8	0.69
5/8"	0426511	SS-DRC-10	SS-1014-1	SS-10BF10	2.17	0426591	B-DRC-10	B-1014-1	B-10BF10	0.78
3/4"	0426512	SS-DRC-12	SS-1214-1	SS-12BF12	3.05	0426592	B-DRC-12	B-1214-1	B-12BF12	1.08
7/8"	0426513	SS-DRC-14	SS-1414-1	SS-14BF14	4.05	0426593	B-DRC-14	B-1414-1	B-14BF14	1.27
1"	0426514	SS-DRC-16	SS-1614-1	SS-16BF16	4.65	0426594	B-DRC-16	B-1614-1	B-16BF16	1.74

NYLON LF3000 PUSH-TO-CONNECT FITTINGS

Nylon LF3000 Push-to-Connect Fittings



Specifications for Nylon Push-To-Connect Fittings(LF3000 System)

Fluids: Compressed air and vacuum

Body Material: Nylon 6.6 or Nickel Plated Brass

Seal: Nitrile

Pressure Rating: 28" Hg to 290 PSI

Temperature Rating: -4F to 175F

Thread Sizes: 10-32 to 1/2 and M5 to 1/2 (BSP)

Thread Types: NPT, BSPT, BSPP, UNF, Metric

Tube Sizes: 1/8" to 1/2" and 3mm to 14mm

Tubing Types: Nylon, Polyurethane, Polyethylene, Teflon

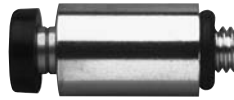

Straight Male Connector
UNF



Straight Male Connector
NPT

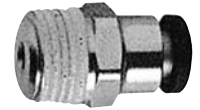

Straight Male Connector
BSPT



Male Elbow
UNF / NPT



Male Elbow
BSPT

Push to Connect
Fittings

Tube O.D.	Thread	Straight Male Connector Fractional Tube x Male NPT or 10-32 UNF			Straight Male Connector Fractional Tube x Male BSPT			Male Elbow Fractional Tube x Male NPT or 10-32 UNF			Male Elbow Fractional Tube x Male BSPT		
		Part No.	Vendor No.	Price /Each	Part No.	Vendor No.	Price /Each	Part No.	Vendor No.	Price /Each	Part No.	Vendor No.	Price /Each
1/8"	10-32	442054	3171 53 20	\$2.51				0442256	3109 53 20	\$5.19			
1/8"	1/16	442057	3175 53 08	3.82				442028	3109 53 08	7.34			
1/8"	1/8	442058	3175 53 11	2.52	0449602	3175 53 10	6.50	442029	3109 53 11	3.60	0449617	3109 53 10	5.25
1/8"	1/4	442059	3175 53 14	4.83				442030	3109 53 14	5.60			
5/32"	10-32	442055	3171 04 20	2.44				442031	3109 04 20	4.62			
5/32"	1/8"	442060	3175 04 11	2.25	442136	3175 04 10	3.04	442032	3109 04 11	3.42	442109	3109 04 10	4.38
5/32"	1/4	442061	3175 04 14	3.80	442137	3175 04 13	4.95	442033	3109 04 14	6.22	442110	3109 04 13	5.91
3/16"	1/8	442062	3175 55 11	3.00	0450003	3175 55 10	5.56	442034	3109 55 11	7.44	0450011	3109 55 10	7.94
3/16"	1/4	442063	3175 55 14	4.87	0450002	3175 55 13	6.56						
1/4"	10-32	442056	3171 56 20	3.60				0442257	3109 56 20	4.88			
1/4"	1/8"	442064	3175 56 11	3.17	0449514	3175 56 10	4.81	442035	3109 56 11	3.65	0449553	3109 56 10	4.88
1/4"	1/4"	442065	3175 56 14	3.11	0449513	3175 56 13	4.94	442036	3109 56 14	3.95	0449532	3109 56 13	4.94
1/4"	3/8	442066	3175 56 18	4.48				442037	3109 56 18	5.66			
5/16"	1/8	442067	3175 08 11	5.61	442140	3175 08 10	5.13	442038	3109 08 11	7.20	442113	3109 08 10	5.95
5/16"	1/4	442068	3175 08 14	5.20	442141	3175 08 13	5.39	442039	3109 08 14	7.71	442114	3109 08 13	6.39
5/16"	3/8	442069	3175 08 18	6.86	442142	3175 08 17	5.79	442040	3109 08 18	7.27	442115	3109 08 17	7.56
5/16"	1/2				0451307	3175 08 21	5.88				0451375	3109 08 21	7.75
3/8"	1/8	442070	3175 60 11	5.92				442041	3109 60 11	5.84			
3/8"	1/4"	442071	3175 60 14	4.51	0450044	3175 60 13	7.31	442042	3109 60 14	5.71	0450063	3109 60 13	5.13
3/8"	3/8	442072	3175 60 18	5.76	0450045	3175 60 17	7.50	442043	3109 60 18	5.85	0450707	3109 60 17	5.31
3/8"	1/2	442073	3175 60 22	8.11	0450043	3175 60 21	8.69	442044	3109 60 22	8.37			
1/2"	1/4	442074	3175 62 14	7.72	0449455	3175 62 13	11.69	442045	3109 62 14	6.47	0449470	3109 62 13	14.31
1/2"	3/8	442075	3175 62 18	8.57	0449456	3175 62 17	12.00	0442258	3109 62 18	7.75	0449483	3109 62 17	14.44
1/2"	1/2	442076	3175 62 22	8.07	0449454	3175 62 21	12.13	0442259	3109 62 22	8.63	0449462	3109 62 21	14.88



Extended Male
Elbow
NPT



45° Male Elbow
UNF / NPT

O.D.	Thread	Extended Male Elbow Fractional Tube x Male NPT			45 Degree Male Elbow Fractional Tube x Male NPT or 10-32 UNF		
		Part No.	Vendor No.	Price /Each	Part No.	Vendor No.	Price /Each
1/8"	10-32				0449625	3133 53 20	\$5.38
1/8"	1/8	0445836	3129 53 11	5.38	0449616	3113 53 11	3.94
1/8"	1/4	0445837	3129 53 14	5.50			
5/32"	1/8"	0442267	3129 04 11	6.75			
5/32"	1/4	0442268	3129 04 14	8.88			
1/4"	1/8"	0442269	3129 56 11	5.60	0449552	3113 56 11	3.81
1/4"	1/4"	0442270	3129 56 14	5.50	0449531	3113 56 14	4.13
1/4"	3/8	0449571	3129 56 18	7.00			
5/16"	1/8	0442271	3129 08 11	8.63			
5/16"	1/4	0442272	3129 08 14	9.31			
3/8"	1/8	0450692	3129 60 11	7.75			
3/8"	1/4"	0442273	3129 60 14	8.17	0450062	3113 60 14	5.56
3/8"	3/8	0442274	3129 60 18	9.50	0450706	3113 60 18	5.75

Legris' fittings have a unique seal - The 'D' seal within the fitting provides a positive seal on the O.D. of the tube, in both static and dynamic positions due to an optimized design of the fitting cavity.

NYLON LF3000 PUSH-TO-CONNECT FITTINGS

Nylon LF3000 Push-to-Connect Fittings Cont.



Push to Connect Fittings



Male Branch Tee
UNF / NPT



Male Branch Tee
BSPT



Male Run Tee
UNF / NPT



Male Standpipe
UNF / NPT



"Y" Male
NPT

Tube O.D.	Thread	Male Branch Tee Fractional Tube x Male NPT/ 10-32 UNF			Male Branch Tee Fractional Tube x Male BSPT			Male Run Tee Fractional Tube x Male NPT/ 10-32 UNF			Male Standpipe NPT / 10-32 UNF			"Y" Male Fractional Tube x NPT		
		Part No.	No.	Price	Part No.	No.	Price	Part No.	No.	Price	Part No.	No.	Price	Part No.	No.	Price
1/8"	10-32	0442243	3108 53 20	\$7.13				0442226	3103 53 20	\$7.25						
1/8"	1/16	0442244	3108 53 08	8.00				0442227	3103 53 08	7.31						
1/8"	1/8	0442245	3108 53 11	5.36	0451592	3108 53 10	12.19	0442228	3103 53 11	5.56						
1/8"	1/4	0445832	3108 53 14	5.63												
5/32"	10-32	442021	3108 04 20	7.95				0442229	3103 04 20	8.04	0442275	3131 04 20	10.63			
5/32"	1/8	442022	3108 04 11	5.18	0442491	3108 04 10	6.36	0442230	3103 04 11	5.57	0442276	3121 04 11	3.00	0442284	3148 04 11	6.99
5/32"	1/4	442023	3108 04 14	7.80	0442492	3108 04 13	8.32	0442231	3103 04 14	7.69	0442277	3121 04 14	3.56	0442285	3148 04 14	6.53
3/16"	1/8	442024	3108 55 11	8.77				0442232	3103 55 11	9.68						
1/4"	1/8	442025	3108 56 11	4.77	0449551	3108 56 10	6.69	442165	3103 56 11	5.06	0449555	3121 56 11	4.06	0442286	3148 56 11	8.09
1/4"	1/4	442026	3108 56 14	5.21	0449530	3108 56 13	6.75	442166	3103 56 14	5.14	0445835	3121 56 14	3.06	0442287	3148 56 14	7.00
1/4"	3/8	442027	3108 56 18	6.33				442167	3103 56 18	6.07						
5/16"	1/8	0442246	3108 08 11	7.16	442154	3108 08 10	7.39	0442233	3103 08 11	7.00						
5/16"	1/4	0442247	3108 08 14	7.56	442155	3108 08 13	8.05	0442234	3103 08 14	7.25						
5/16"	3/8	0442248	3108 08 18	7.50	0442494	3108 08 17	7.75	0442235	3103 08 18	7.50						
3/8"	1/8	0442249	3108 60 11	9.89				0442236	3103 60 11	9.19						
3/8"	1/4	0442250	3108 60 14	7.16	0450061	3108 60 13	7.06	0442237	3103 60 14	7.81	0442280	3121 60 14	3.19	0445839	3148 60 14	9.50
3/8"	3/8	0442251	3108 60 18	8.40	0450705	3108 60 17	7.38	0442238	3103 60 18	9.08	0442281	3121 60 18	3.69	0445840	3148 60 18	11.38
3/8"	1/2	0442252	3108 60 22	10.50				0442239	3103 60 22	11.80						
1/2"	1/4	0442253	3108 62 14	9.13				0442240	3103 62 14	9.13						
1/2"	3/8	0442254	3108 62 18	11.44				0442241	3103 62 18	11.44						
1/2"	1/2	0442255	3108 62 22	12.94				0442242	3103 62 22	12.94						



Female Elbow
NPT



Female Branch Tee
NPT



Straight Female Connector
NPT



Single Banjo



"Y"

Tube O.D.	Thread	Female Elbow Fractional Tube x NPT			Female Branch Tee Fractional Tube x NPT			Straight Female Connector Fractional Tube x NPT			Single Banjo Fractional Tube x NPT / 10-32 UNF			"Y" Fractional Tube x Tube		
		Part No.	No.	Price	Part No.	No.	Price	Part No.	No.	Price	Part No.	No.	Price	Part No.	No.	Price
1/8"	10-32										0442294	3118 53 20	\$5.46			
1/8"	1/8	0442206	3009 53 11	6.52	0442215	3008 53 11	7.73	0442260	3014 53 11	4.15				0442636	3140 53 00	4.19
1/8"	1/4							442082	3014 53 14	5.82						
5/32"	10-32										442046	3118 04 20	5.37	442122	3140 04 00	4.50
5/32"	1/8	0442207	3009 04 11	5.31	0442216	3008 04 11	6.42	442083	3014 04 11	5.25	0400179	3018 04 11	13.50			
5/32"	1/4	0442208	3009 04 14	7.64	0442217	3008 04 14	7.69	442084	3014 04 14	6.87						
3/16"	1/8							0442261	3014 55 11	5.13						
3/16"	1/4							0442262	3014 55 14	16.69						
1/4"	10-32										0442295	3118 56 20	9.31			
1/4"	1/8	0442209	3009 56 11	4.13	0442218	3008 56 11	5.87	442085	3014 56 11	4.07	0400180	3018 56 11	13.50			
1/4"	1/4	0442210	3009 56 14	6.13	0442219	3008 56 14	7.44	0442263	3014 56 14	5.60	0442290	3018 56 14	11.56	0442225	3140 56 00	4.98
5/16"	1/8	0442211	3009 08 11	8.31	0442220	3008 08 11	6.69	0442264	3014 08 11	7.13				442125	3140 08 00	6.50
5/16"	1/4	0442212	3009 08 14	9.28	0442221	3008 08 14	10.56	0442265	3014 08 14	7.13						
3/8"	1/8							0450694	3014 60 11	6.75						
3/8"	1/4	0442213	3009 60 14	7.56	0442222	3008 60 14	9.06	442086	3014 60 14	8.39						
3/8"	3/8							0442266	3014 60 18	9.12				0442184	3140 60 00	8.77
1/2"	3/8	0442214	3009 62 18	11.85	0442223	3008 62 18	13.14	0445829	3014 62 18	8.56						
1/2"	1/2							0445830	3014 62 22	8.94						

NYLON LF3000 PUSH-TO-CONNECT FITTINGS

Nylon LF3000 Push-to-Connect Fittings Cont.



Union / Unequal Union



Union Elbow / Unequal Union Elbow



Tee / Unequal Tee



Bulkhead Union



Elbow Bulkhead

Tube O.D. x Tube O.D.	Union / Unequal Union Fractional Tube x Tube			Union Elbow / Unequal Elbow Fractional Tube x Tube			Tee / Unequal Tee Fractional Tube x Tube x Tube			Bulkhead Union Fractional Tube x Tube			Elbow Bulkhead Fractional Tube x Tube		
	Part No.	Vendor No.	Price /Each	Part No.	Vendor No.	Price /Each	Part No.	Vendor No.	Price /Each	Part No.	Vendor No.	Price /Each	Part No.	Vendor No.	Price /Each
1/8" x 1/8"	442047	3106 53 00	\$3.69	0442305	3102 53 00	\$3.88	442005	3104 53 00	\$5.50	442077	3116 53 00	\$5.28	0449585	3139 53 00	\$7.25
1/8" x 1/4"	0442940	3106 53 56	4.31	0442936	3102 53 56	3.88	0445831	3104 53 56	5.94						
5/32" x 5/32"	442048	3106 04 00	3.07	442098	3102 04 00	3.49	442006	3104 04 00	4.82	0442301	3116 04 00	5.12	0442592	3139 04 00	13.04
5/32" x 1/4"	0450932	3106 04 56	3.81	0450931	3102 04 56	3.50	0450933	3104 04 56	4.94						
3/16" x 3/16"	442018	3106 55 00	4.19	442000	3102 55 00	5.29	442007	3104 55 00	7.32						
1/4" x 1/8"							0451989	3104 56 53	5.50						
1/4" x 1/4"	442019	3106 56 00	3.72	442001	3102 56 00	4.27	442008	3104 56 00	5.44	442080	3116 56 00	5.88	0449492	3139 56 00	7.56
1/4" x 3/8"							0449578	3104 56 60	8.63						
5/16" x 5/16"	442020	3106 08 00	4.91	442002	3102 08 00	5.50	442009	3104 08 00	6.97	442081	3116 08 00	7.88	0442594	3139 08 00	16.59
3/8" x 1/4"	0442941	3106 60 56	7.13	0442937	3102 60 56	7.69									
3/8" x 3/8"	442049	3106 60 00	4.86	442003	3102 60 00	5.99	442010	3104 60 00	7.41	0442304	3116 60 00	7.94	0450021	3139 60 00	10.69
3/8" x 1/2"							0450054	3104 60 62	10.88						
1/2" x 1/2"	442050	3106 62 00	8.21	442004	3102 62 00	8.30	442011	3104 62 00	11.39	0445833	3116 62 00	11.38	0449435	3139 62 00	13.00



Plug-In Elbow



Plug-In "Y"



Reducer



Plug



Barbed Connector

Tube O.D. x Tube O.D.	Plug-In Elbow Fractional Tube x Tube			Plug-In "Y" Fractional Tube x Tube			Reducer Fractional Tube x Tube x Tube			Plug Fractional Tube x Tube			Barbed Connector Fractional Tube x Tube		
	Part No.	Vendor No.	Price /Each	Part No.	Vendor No.	Price /Each	Part No.	Vendor No.	Price /Each	Part No.	Vendor No.	Price /Each	Part No.	Vendor No.	Price /Each
1/8" x 5/32"							0442188	3166 53 04	\$4.00						
1/8" x 1/8"	0445842	3182 53 00	2.00	0442185	3142 53 00	4.12				442051	3126 53 00	1.43			
1/8" x 3/16"							0442189	3166 53 55	4.52						
1/8" x 1/4"							0442190	3166 53 56	4.00						
5/32" x 5/32"	0442203	3182 04 00	1.75							442052	3126 04 00	0.44	0442368	3122 04 05	3.08
5/32" x 1/8"													0442369	3122 04 53	1.47
5/32" x 3/16"							0442191	3166 04 55	1.45						
5/32" x 1/4"	0445841	3182 04 56	4.88				0442192	3166 04 56	1.44						
5/32" x 5/16"							0442193	3166 04 08	3.21						
5/32" x 3/8"							0442194	3166 54 60	5.69						
3/16" x 3/16"										442053	3126 55 00	1.48			
3/16" x 1/4"							0442195	3166 55 56	2.66						
3/16" x 5/16"							0442196	3166 55 08	2.63						
1/4" x 3/16"													0442370	3122 56 55	5.92
1/4" x 1/4"	0442204	3182 56 00	1.81	0400140	3142 56 00	6.38				0442224	3126 56 00	1.07			
1/4" x 5/16"							0442198	3166 56 08	2.15						
1/4" x 3/8"	0449572	3182 56 60	4.38				0442199	3166 56 60	1.95						
1/4" x 1/2"							0442200	3166 56 62	5.62						
5/16" x 3/8"							0442201	3166 08 60	2.50						
5/16" x 1/2"							0442202	3166 08 62	6.99						
3/8" x 5/16"													0442373	3122 60 08	4.62
3/8" x 3/8"	0450708	3182 60 00	4.31	0400141	3142 60 00	6.63				0442365	3126 60 00	2.29			
3/8" x 1/2"							0442320	3166 60 62	3.19						
1/2" x 1/2"	0449463	3182 62 00	5.38							0442366	3126 62 00	2.54			

Push to Connect
Fittings

NYLON LF3000 PUSH-TO-CONNECT FITTINGS

Nylon LF3000 Push-to-Connect Fittings Cont.



Fractional Fittings Kit Part #0442939

- Kit contains: 22 popular items and sizes (166 total pieces)
- Glass-filled, nylon constructed
- Easy to use push-in-connection
- Compatible with Nylon, Polyurethane, and Polyethylene tubing
- Seals tubing with an O-ring with a 'D' seal, which provides a positive seal on the O.D. of the tube



Part No.	Description	Price /Each
0442939	Fractional Fittings Kit	\$589.00

Kit Components

Tube O.D.	Thread	Type	Part No.	Pkg. Qty.
1/8"	1/8"	Straight Male Connector Fractional Tube x Male NPT	442058	10
5/32"	1/8"	Straight Male Connector Fractional Tube x Male NPT	442060	10
1/4"	1/8"	Straight Male Connector Fractional Tube x Male NPT	442064	10
1/4"	1/4"	Straight Male Connector Fractional Tube x Male NPT	442065	10
3/8"	1/4"	Straight Male Connector Fractional Tube x Male NPT	442071	5
3/8"	3/8"	Straight Male Connector Fractional Tube x Male NPT	442072	5
5/32"	1/8"	Male Elbow Fractional Tube x Male NPT	442032	10
1/4"	1/8"	Male Elbow Fractional Tube x Male NPT	442035	10
1/4"	1/4"	Male Elbow Fractional Tube x Male NPT	442036	10
3/8"	1/8"	Male Elbow Fractional Tube x Male NPT	442041	5
3/8"	1/4"	Male Elbow Fractional Tube x Male NPT	442042	5
3/8"	3/8"	Male Elbow Fractional Tube x Male NPT	442043	5
5/32"		Union / Unequal Union Fractional Tube x Tube	442048	10
1/4"		Union / Unequal Union Fractional Tube x Tube	442019	10
3/8"		Union / Unequal Union Fractional Tube x Tube	442049	5
5/32"		"Y" Connector	0442182	10
1/4"	1/4"	"Y" Fractional Tube x Tube	0442225	10
3/8"	3/8"	"Y" Fractional Tube x Tube	0442184	5
5/32"		Tee / Unequal Tee Fractional Tube x Tube x Tube	442006	10
1/4"		Tee / Unequal Tee Fractional Tube x Tube x Tube	442008	5
3/8"		Tee / Unequal Tee Fractional Tube x Tube x Tube	442010	5
		Tubing Cutter	0450606	1

The Leader in Innovative Connection Solutions

- Fittings
- Function Valves
- Tubing
- Accessories
- Air Preparation



NYLON LF3000 PUSH-TO-CONNECT FITTINGS

Nylon LF3000 Push-to-Connect Fittings Cont.



Nylon LF3000 Metric Push-to-Connect Fittings



Straight Male Connector
BSPT



Straight Male Connector
BSPP, M3, M5, M7



Male Elbow
BSPT



Male Elbow
BSPP, M3, M5, M7



Extended Male Elbow
BSPT



45°

Tube O.D.	Thread	Straight Male Connector Tube x Male BSPT			Straight Male Connector Metric Tube x Male BSPP, M3, M5 or M7			Male Elbow Tube x Male BSPT			Male Elbow Metric Tube x BSPP, M3, M5 or M7			Extended Male Elbow Metric Tube x Male BSPT			45 Degree Male Elbow Metric Tube x Male BSPT		
		Part No.	Vendor No.	Price	Part No.	Vendor No.	Price	Part No.	Vendor No.	Price	Part No.	Vendor No.	Price	Part No.	Vendor No.	Price	Part No.	Vendor No.	Price
3mm	M3				0450746	3101 03 09	\$5.88				0450718	3199 03 09	\$5.75						
3mm	M5				0450747	3101 03 19	5.75				0450727	3199 03 19	5.63						
4mm	M3				0450887	3101 04 09	4.25				0450779	3199 04 09	5.88						
4mm	M5				442087	3101 04 19	3.98				0442475	3199 04 19	3.94						
4mm	M7				0450891	3101 04 55	4.06				0450799	3199 04 55	3.50						
4mm	1/8	442136	3175 04 10	3.04	442088	3101 04 10	3.39	442109	3109 04 10	4.38	0442476	3199 04 10	4.46	0442426	3129 04 10	12.65	0450852	3113 04 10	3.75
4mm	1/4	442137	3175 04 13	4.95	442089	3101 04 13	5.01	442110	3109 04 13	5.91	0442477	3199 04 13	7.56	0442427	3129 04 13	10.95			
6mm	M5				442090	3101 06 19	5.90				0442478	3199 06 19	4.46						
6mm	M7				0451179	3101 06 55	5.69				0451992	3199 06 55	3.50						
6mm	1/8	442138	3175 06 10	3.46	442091	3101 06 10	3.91	442111	3109 06 10	4.45	0442479	3199 06 10	4.77	0442428	3129 06 10	9.50	0451122	3113 06 10	4.00
6mm	1/4	442139	3175 06 13	4.01	442092	3101 06 13	4.58	442112	3109 06 13	4.50	0442480	3199 06 13	6.85	0442429	3129 06 13	15.76	0451108	3113 06 13	4.75
6mm	3/8	0451131	3175 06 17	3.94	0451178	3101 06 17	4.19	0451187	3109 06 17	3.88	0451032	3199 06 17	6.19						
6mm	1/2	0451103	3175 06 21	5.56	0451169	3101 06 21	5.88	0451180	3109 06 21	6.38	0450993	3199 06 21	6.19						
8mm	1/8	442140	3175 08 10	5.13	442093	3101 08 10	5.54	442113	3109 08 10	5.95	0442481	3199 08 10	7.48	0442430	3129 08 10	14.98	0451324	3113 08 10	4.19
8mm	1/4	442141	3175 08 13	5.39	442094	3101 08 13	5.40	442114	3109 08 13	6.39	0442482	3199 08 13	7.01	0442431	3129 08 13	16.21	0451313	3113 08 13	4.94
8mm	3/8	442142	3175 08 17	5.79	442095	3101 08 17	7.72	442115	3109 08 17	7.56	0442483	3199 08 17	9.50	0442432	3129 08 17	14.29	0451335	3113 08 17	5.50
8mm	1/2	0451307	3175 08 21	5.88	0451367	3101 08 21	7.69	0451375	3109 08 21	7.75	0451193	3199 08 21	7.88						
10mm	1/4	442143	3175 10 13	6.12	442096	3101 10 13	8.93	0442457	3109 10 13	11.03	0442484	3199 10 13	10.62	0442433	3129 10 13	8.59	0449717	3113 10 13	5.63
10mm	3/8	442144	3175 10 17	6.81	442097	3101 10 17	9.59	0442458	3109 10 17	10.51	0442485	3199 10 17	12.62	0442434	3129 10 17	16.59	0449724	3113 10 17	6.38
10mm	1/2	442145	3175 10 21	8.38	0442401	3101 10 21	12.63	0442459	3109 10 21	10.95	0442486	3199 10 21	7.74						
12mm	1/4	0442396	3175 12 13	7.42	0442402	3101 12 13	11.76	0442460	3109 12 13	12.13	0442487	3199 12 13	13.25				0449835	3113 12 13	9.44
12mm	3/8	0442397	3175 12 17	7.60	0442403	3101 12 17	8.01	0442461	3109 12 17	13.13	0442488	3199 12 17	12.87				0449840	3113 12 17	9.94
12mm	1/2	0442398	3175 12 21	9.20	0442404	3101 12 21	13.03	0442462	3109 12 21	13.53	0449774	3199 12 21	13.13				0449829	3113 12 21	10.75
14mm	3/8	0442399	3175 14 17	9.58	0442405	3101 14 17	9.58	0442463	3109 14 17	13.50	0442489	3199 14 17	14.12						
14mm	1/2	0442400	3175 14 21	9.98	0442406	3101 14 21	10.63	0442464	3109 14 21	17.57	0442490	3199 14 21	13.69	0449915	3129 14 21	16.50			



Male Branch Tee
BSPT



Male Branch Tee
BSPP, M5



Male Run Tee
BSPT



Male Run Tee
BSPP, M5

Tube O.D.	Thread	Male Branch Tee Metric Tube x Male BSPT			Male Branch Tee Metric Tube x BSPP or M5			Male Run Tee Metric Tube x Male BSPT			Male Run Tee Metric Tube x BSPP or M5		
		Part No.	Vendor No.	Price	Part No.	Vendor No.	Price	Part No.	Vendor No.	Price	Part No.	Vendor No.	Price
4mm	1/8	0442491	3108 04 10	6.36	0442531	3198 04 10	6.12	442149	3103 04 10	6.47	0442514	3193 04 10	\$6.84
4mm	1/4	0442492	3108 04 13	8.32	0442532	3198 04 13	9.17	0442502	3103 04 13	8.54	0442515	3193 04 13	9.39
6mm	M5				0442533	3198 06 19	7.64				0442516	3193 06 19	8.14
6mm	1/8	0442493	3108 06 10	6.06	0442534	3198 06 10	6.68	442150	3103 06 10	6.43	0442517	3193 06 10	6.68
6mm	1/4	442153	3108 06 13	6.53	0442535	3198 06 13	7.96	442151	3103 06 13	6.53	0442518	3193 06 13	7.96
8mm	1/8	442154	3108 08 10	7.39	0442536	3198 08 10	8.32	442152	3103 08 10	8.17	0442519	3193 08 10	8.32
8mm	1/4	442155	3108 08 13	8.05	0442537	3198 08 13	12.15	0442503	3103 08 13	8.42	0442520	3193 08 13	8.60
8mm	3/8	0442494	3108 08 17	7.75	0442538	3198 08 17	11.16	0442504	3103 08 17	8.14	0400195	3193 08 17	8.31
10mm	1/4	442156	3108 10 13	15.52	0442539	3198 10 13	15.25	0442505	3103 10 13	15.06	0442522	3193 10 13	14.56
10mm	3/8	0442495	3108 10 17	15.65	0442540	3198 10 17	16.11	0442506	3103 10 17	15.12	0442523	3193 10 17	16.11
10mm	1/2	0442496	3108 10 21	15.46									
12mm	1/4	0442497	3108 12 13	17.19									
12mm	3/8	0442498	3108 12 17	17.19									
12mm	1/2	0442499	3108 12 21	18.39									
14mm	3/8	0442500	3108 14 17	18.81									
14mm	1/2	0442501	3108 14 21	19.54									

The : symbol after a price denotes that it is a Direct Ship Product (DSP) and shipping, availability & lead times may vary.

NYLON LF3000 PUSH-TO-CONNECT FITTINGS

Nylon LF3000 Push-to-Connect Fittings Cont.



Push to Connect Fittings



“Y”
BSPT



“Y”
BSPP, M5



Female Elbow
BSPP



Straight Female Connector
BSPP, M5



Single Banjo
BSPT



Single Banjo
BSPP, M5

Tube O.D.	Thread	“Y” Male Metric Tube x BSPT				“Y” Male Metric Tube x BSPP or M5				Female Elbow Metric Tube x BSPP				Straight Female Connector Metric Tube x BSPP or M5				Single Banjo Metric Tube x BSPT				Single Banjo Metric Tube x BSPP or M5					
		Part No.	No.	Price		Part No.	No.	Price		Part No.	No.	Price		Part No.	No.	Price		Part No.	No.	Price		Part No.	No.	Price			
4mm	M5					0450786	3158 04 19	\$6.50					0442419	3114 04 19	\$8.90								442160	3118 04 19	\$6.57		
4mm	1/8	0442407	3148 04 10	7.73		0442413	3158 04 10	10.62		0442603	3192 04 10	2.95		0442420	3114 04 10	5.30							442161	3118 04 10	6.87		
4mm	1/4	0442408	3148 04 13	7.96						0442604	3192 04 13	4.11		0442421	3114 04 13	7.06											
6mm	M5																						0451042	3118 06 19	8.63		
6mm	1/8	0442409	3148 06 10	7.29		0442415	3158 06 10	10.45		0442605	3192 06 10	3.06		442157	3114 06 10	5.13		0451117	3018 06 10	6.44		442162	3118 06 10	6.87			
6mm	1/4	0442410	3148 06 13	8.01		0442416	3158 06 13	8.59		0442606	3192 06 13	4.16		442158	3114 06 13	5.68		0451104	3018 06 13	8.31		442163	3118 06 13	8.77			
8mm	1/8	0442411	3148 08 10	7.86		0442417	3158 08 10	13.59		0442607	3192 08 10	3.58		442159	3114 08 10	6.44		0451320	3018 08 10	7.94		442164	3118 08 10	8.37			
8mm	1/4	0442412	3148 08 13	8.59		0442418	3158 08 13	14.52		0442608	3192 08 13	4.28		0442422	3114 08 13	6.42		0451308	3018 08 13	8.81		0451194	3118 08 13	8.88			
8mm	3/8	0451340	3148 08 17	9.69		0451246	3158 08 17	14.56						0451243	3114 08 17	7.44		0451331	3018 08 17	10.69		0451231	3118 08 17	10.69			
10mm	1/4									0442610	3192 10 13	7.68		0449642	3114 10 13	8.94		0449715	3018 10 13	13.50		0449638	3118 10 13	13.50			
10mm	3/8									0442611	3192 10 17	6.02		0442423	3114 10 17	10.39						0449648	3118 10 17	12.31			
12mm	3/8													0442424	3114 12 17	13.15											
12mm	1/2													0442425	3114 12 21	16.44											



Union / Unequal Union



Union Elbow /
Unequal Union Elbow



Tee/Unequal Tee



Bulkhead Union



Elbow Bulkhead

Tube O.D. (mm)	Tube O.D.	Union / Unequal Union Metric Tube x Tube				Union Elbow / Unequal Elbow Metric Tube x Tube				Tee / Unequal Tee Metric Tube x Tube x Tube				Bulkhead Union Metric Tube x Tube				Elbow Bulkhead Metric Tube x Tube						
		Part No.	No.	Price		Part No.	No.	Price		Part No.	No.	Price		Part No.	No.	Price		Part No.	No.	Price				
3mm	3mm	0450738	3106 03 00	\$3.88						0450736	3104 03 00	\$5.56												
3mm	4mm	0450745	3106 03 04	3.38																				
4mm	6mm	0442578	3106 04 06	6.97		0450877	3102 04 06	3.69		0450875	3104 04 06	5.00												
4mm	8mm	0442579	3106 04 08	7.32																				
6mm	6mm	442013	3106 06 00	3.94		442099	3102 06 00	4.10		442105	3104 06 00	5.32		0442621	3116 06 00	5.56		0442593	3139 06 00	11.96				
6mm	4mm									0451148	3104 06 04	5.00												
6mm	8mm	0442580	3106 06 08	7.54		0451168	3102 06 08	4.31		0451167	3104 06 08	6.38												
6mm	10mm	0442581	3106 06 10	9.50																				
8mm	8mm					442100	3102 08 00	4.34																
8mm	6mm									0451361	3104 08 06	5.88												
8mm	10mm	0442582	3106 08 10	9.52		0451353	3102 08 10	8.50		0451352	3104 08 10	12.38												
10mm	8mm	442015	3106 10 00	9.57		442101	3102 10 00	8.93		442107	3104 10 00	12.90		0442623	3116 10 00	9.19		0442595	3139 10 00	19.99				
10mm	12mm	0449751	3106 10 12	9.94		0449750	3102 10 12	10.69		0449749	3104 10 12	14.31												
12mm	12mm	442016	3106 12 00	11.85		442102	3102 12 00	11.29		442108	3104 12 00	15.51		0442624	3116 12 00	12.44		0442596	3139 12 00	23.92				
12mm	10mm									0449850	3104 12 10	14.31												
12mm	14mm	0451990	3106 12 14	13.56																				
14mm	14mm	442017	3106 14 00	15.72		442103	3102 14 00	13.50		0442583	3104 14 00	19.22		0442625	3116 14 00	16.69		0442597	3139 14 00	43.81				

Fleet Needs? Check out the full line of Legris Push-To-Connect DOT fittings and tubing on page 10-179!

NYLON LF3000 & SS LF3800 PUSH-TO-CONNECT FITTINGS

Nylon LF3000 Push-to-Connect Fittings Cont.

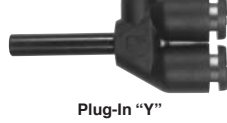

Tube O.D. (mm)	Tube O.D.	Plug-In Elbow Tube x Tube			Plug-In "Y" Metric Tube			Reducer Metric Tube			Plug Metric Tube			Barbed Connector Metric Tube		
		Part No.	Vendor No.	Price /Each	Part No.	Vendor No.	Price /Each	Part No.	Vendor No.	Price /Each	Part No.	Vendor No.	Price /Each	Part No.	Vendor No.	Price /Each
4mm	4mm	442146	3182 04 00	\$1.76	0442186	3142 04 00	\$6.25				442116	3126 04 00	\$0.50			
4mm	6mm	0450868	3182 04 06	2.63				442129	3166 04 06	2.91						
4mm	8mm							442130	3166 04 08	2.81						
6mm	6mm	442148	3182 06 00	2.11	0451153	3142 06 00	3.56				442117	3126 06 00	1.32			
6mm	4mm	442147	3182 06 04	2.45												
6mm	5mm													0442694	3122 06 05	3.01
6mm	8mm							442132	3166 06 08	3.26						
6mm	10mm							442133	3166 06 10	3.64						
8mm	8mm	0442205	3182 08 00	2.13	0451366	3142 08 00	3.75				442118	3126 08 00	1.48			
8mm	10mm	0451348	3182 08 10	4.88				0442626	3166 08 10	4.19						
8mm	12mm							0442627	3166 08 12	4.89						
10mm	10mm	0442633	3182 10 00	4.88	0449740	3142 10 00	5.50				442119	3126 10 00	2.97			
10mm	8mm													0442698	3122 10 08	3.74
10mm	12mm							0442629	3166 10 12	7.94						
10mm	14mm							0442630	3166 10 14	9.55						
12mm	12mm	0442634	3182 12 00	4.23	0449856	3142 12 00	7.31				442120	3126 12 00	4.50			
12mm	14mm							0442631	3166 12 14	11.76						
14mm	14mm										442121	3126 14 00	5.00			

Stainless Steel LF3800 Push-to-Connect Fittings

Specifications for Stainless Steel Push-To-Connect Fittings(LF3800 System)

Compatible Fluids: All fluids compatible with fitting and tubing material.

Body Material: Stainless Steel AISI 316 Body

Seal: FKM "O" Ring Seal

Pressure Rating: 0-290 PSI

Temperature Range: -4°F to 250°F

Thread Sizes: 1/8" to 1/2"

Thread Types: NPT, BSPT, BSPP, UNF, Metric

Tubing Types: Nylon, Polyurethane, Polyethylene, Teflon, Steel, Copper

Industrial Applications: Chemical, Food, Packaging, Medical



Stainless Steel LF3800 Fractional Push-to-Connect Fittings

Tube O.D.	Thread	Straight Male Connector Fractional Tube x Male NPT			Male Elbow Fractional Tube x Male NPT 10-32 UNF			Male Standpipe Fractional Tube x NPT			Union Fractional Tube x Tube			Bulkhead Union Fractional Tube x Male NPT		
		Part No.	Vendor No.	Price /Each	Part No.	Vendor No.	Price /Each	Part No.	Vendor No.	Price /Each	Part No.	Vendor No.	Price /Each	Part No.	Vendor No.	Price /Each
5/32"											0442852	3806 04 00	\$32.84	0442858	3816 04 00	\$45.08
5/32"	10-32				0442848	3899 04 20	60.85									
5/32"	1/8	0442813	3805 04 11	29.13	0442836	3889 04 11	48.80	0442825	3821 04 11	12.43						
3/16"								0442853	3806 55 00	45.56	0442859	3816 55 00	70.75			
3/16"	1/8	0442814	3805 55 11	30.64	0442837	3889 55 11	55.45	0442826	3821 55 11	19.63						
3/16"	1/4	0442815	3805 55 14	47.43	0442838	3889 55 14	61.60									
1/4"								0442854	3806 56 00	44.31	0442860	3816 56 00	90.38			
1/4"	1/8	0442816	3805 56 11	41.65	0442839	3889 56 11	57.19	0442827	3821 56 11	24.17						
1/4"	1/4	0442817	3805 56 14	41.69	0442840	3889 56 14	64.06	0442828	3821 56 14	32.84						
5/16"								0442855	3806 08 00	41.42	0442861	3816 08 00	59.69			
5/16"	1/8	0442818	3805 08 11	42.65	0442841	3889 08 11	68.45	0442829	3821 08 11	17.47						
5/16"	1/4	0442819	3805 08 14	48.73	0442842	3889 08 14	64.44	0442830	3821 08 14	20.02						
3/8"								0442856	3806 60 00	61.38	0442862	3816 60 00	99.63			
3/8"	1/4	0442820	3805 60 14	49.44	0442843	3889 60 14	104.31	0442831	3821 60 14	29.27						
3/8"	3/8	0442821	3805 60 18	51.69	0442844	3889 60 18	112.08	0442832	3821 60 18	28.05						
1/2"								0442857	3806 62 00	79.56	0442863	3816 62 00	113.67			
1/2"	1/4	0442822	3805 62 14	60.69	0442845	3889 62 14	120.94	0442833	3821 62 14	39.47						
1/2"	3/8	0442823	3805 62 18	68.15	0442846	3889 62 18	134.34	0442834	3821 62 18	45.80						
1/2"	1/2	0442824	3805 62 22	72.46	0442847	3889 62 22	147.58	0442835	3821 62 22	43.04						

The : symbol after a price denotes that it is a Direct Ship Product (DSP) and shipping, availability & lead times may vary.

SS LF3800 Push-to-Connect, Flow Controls

Stainless Steel LF3800 Push-to-Connect Fittings Cont.



Stainless Steel LF3800 Metric Push-to-Connect Fittings



Straight Male Connector
BSPT

Male Elbow
NPT / UNF

Male Standpipe
NPT

Union

Bulkhead Union
UNF / NPT

Stainless Steel LF3800 Metric Push-to-Connect Fittings

Tube O.D.	Thread	Straight Male Connector Metric Tube x BSPT			Male Elbow Tube x Male NPT 10-32 UNF			Male Standpipe Tube x NPT			Union Tube x Tube			Bulkhead Union Tube x Male NPT		
		Part No.	Vendor No.	Price /Each	Part No.	Vendor No.	Price /Each	Part No.	Vendor No.	Price /Each	Part No.	Vendor No.	Price /Each	Part No.	Vendor No.	Price /Each
4mm																
4mm	1/8	0442876	3805 04 10	20.48	0442836	3889 04 11	48.80	0442825	3821 04 11	12.43	0442852	3806 04 00	\$32.84	0442858	3816 04 00	\$45.08
4mm	1/4	0442877	3805 04 13	26.44												
6mm																
6mm	1/8	0442878	3805 06 10	23.65	0448923	3889 06 11	53.94	0448926	3821 06 11	28.13	0442917	3806 06 00	35.41	0442922	3816 06 00	51.68
6mm	1/4	0442879	3805 06 13	27.06	0448917	3889 06 14	60.81	0448919	3821 06 14	32.31						
8mm																
8mm	1/8	0442880	3805 08 10	32.64	0442841	3889 08 11	68.45	0442829	3821 08 11	17.47	0442855	3806 08 00	41.42	0442861	3816 08 00	59.69
8mm	1/4	0442881	3805 08 13	31.88	0442842	3889 08 14	64.44	0442830	3821 08 14	20.02						
8mm	3/8	0442882	3805 08 17	48.10												
10mm																
10mm	1/4	0442883	3805 10 13	47.76	0448876	3889 10 14	81.44	0448878	3821 10 14	22.25	0442919	3806 10 00	70.35	0442924	3816 10 00	67.10
10mm	3/8	0442884	3805 10 17	45.07	0448882	3889 10 18	101.56	0448884	3821 10 18	77.50						
12mm																
											0442920	3806 12 00	65.46	0442925	3816 12 00	112.94

Fractional and Metric Flow Control Regulators

Specifications for Flow Control Regulators

Flow Control Regulators:

Fluids: Compressed air

Body Material: Nylon 6.6

Seal: Nitrile

Pressure Rating: 15-145 PSI

Temperature Range: 30°F to 160°F

Thread Sizes: 1/8" to 1/2" Thread Types: NPT, BSPT,

BSPP, UNF, Metric

Tubing Types: Nylon, Polyurethane, Polyethylene



Compact
Meter Out



Compact
Meter In



Compact
Bi-Directional



Compact Swivel Outlet

Fractional Compact Flow Control Regulators

Tube O.D.	Thread	Compact Flow Control Meter Out - Tube to NPT			Compact Flow Control Meter In - Tube to NPT			Compact Flow Control Bi-Directional - Tube to NPT			Compact Swivel Outlet Tube to NPT		
		Part No.	Vendor No.	Price	Part No.	Vendor No.	Price	Part No.	Vendor No.	Price	Part No.	Vendor No.	Price
5/32"	1/8	0445780	7065 04 11	\$15.85	0450935	7066 04 11	\$15.63	0450934	7067 04 11	\$15.63			
5/32"	1/4	0445912	7065 04 14	19.50									
1/4"	1/8	442172	7065 56 11	17.94	0449543	7066 56 11	17.19	0449542	7067 56 11	17.19	0449544	7045 56 11	19.50
1/4"	1/4	442173	7065 56 14	20.47	0449520	7066 56 14	18.75	0449519	7067 56 14	18.75	0449521	7045 56 14	21.13
3/8"	1/4	442174	7065 60 14	34.67							0449219	7045 60 14	31.19
3/8"	3/8	442175	7065 60 18	39.33							0449224	7045 60 18	37.50

Metric Compact Flow Control Regulators

Tube O.D.	Thread	Compact Flow Control Meter Out - Metric Tube to BSPT or BSPP			Compact Flow Control Bi-Directional - Metric Tube to BSPT		
		Part No.	Vendor No.	Price	Part No.	Vendor No.	Price
6mm	1/8 BSPT	0451120	7065 06 10	\$17.19	0451119	7067 06 10	\$17.19
8mm	1/8 BSPT	0451322	7065 08 10	20.25	0451321	7067 08 10	20.25
8mm	1/4 BSPT	0451311	7065 08 13	20.25	0451310	7067 08 13	20.25
10mm	1/4 BSPT	0449045	7065 10 13	31.19			
10mm	3/8 BSPT	0449047	7065 10 17	37.50			
10mm	1/2 BSPT	0449043	7065 10 21	41.94			
12mm	1/4 BSPT	0449081	7065 12 13	39.00			
12mm	3/8 BSPT	0449085	7065 12 17	39.00			
12mm	1/2 BSPT	0449078	7065 12 21	40.63			
4mm	1/8 BSPP	0445782	7060 04 10	15.85			
6mm	1/8 BSPP	0442783	7060 06 10	20.14			
6mm	1/4 BSPP	0442784	7060 06 13	18.88			
8mm	1/8 BSPP	0442785	7060 08 10	20.51			
8mm	1/4 BSPP	0442786	7060 08 13	22.25			
8mm	3/8 BSPP	0451232	7060 08 17	21.94			

10-32

MINIATURE FLOW CONTROL REGULATORS

Miniature Flow Control Regulators



Fractional Miniature Flow Control Regulators



Miniature Meter Out



Miniature Meter In



Knobless Compact Meter Out



Knobless Miniature Meter Out

Fractional Miniature Flow Control Regulators

Tube O.D.	Thread	Miniature Flow Control Meter Out - Tube to UNF or NPT			Miniature Flow Control Meter In - Tube to UNF or NPT			Knobless Compact Flow Control Meter Out - Tube to UNF or NPT			Knobless Miniature Flow Control Meter Out - Tube to UNF or NPT		
		Part No.	Vendor No.	Price	Part No.	Vendor No.	Price	Part No.	Vendor No.	Price	Part No.	Vendor No.	Price
1/8"	10-32	0449624	7660 53 20	\$14.06	0449623	7669 53 20	\$13.88	0449621	7010 53 20	\$17.38	0449622	7620 53 20	\$14.06
1/8"	1/8	0449618	7665 53 11	14.13				0449615	7015 53 11	14.13	0449614	7625 53 11	15.63
5/32"	10-32	442168	7660 04 20	16.68	0450951	7669 04 20	14.06	0450950	7010 04 20	17.38	0442808	7620 04 20	16.22
5/32"	1/8	442169	7665 04 11	17.63	0450939	7668 04 11	14.13	0450938	7015 04 11	15.63	0442810	7625 04 11	17.25
1/4"	10-32	0442802	7660 56 20	17.19	0449566	7669 56 20	17.19	0449565	7010 56 20	18.38	0442809	7620 56 20	19.14
1/4"	1/8	442170	7665 56 11	19.69	0449554	7668 56 11	17.19	0449550	7015 56 11	17.19	0442811	7625 56 11	18.97
1/4"	1/4	442171	7665 56 14	19.23	0449533	7668 56 14	17.19	0449529	7015 56 14	18.75	0442812	7625 56 14	20.12
5/16"	1/8							0450909	7015 08 11	21.00			
5/16"	1/4							0450906	7015 08 14	21.75			
3/8"	1/4							0449221	7015 60 14	31.19			
3/8"	3/8							0449225	7015 60 18	37.50			

Metric Miniature Flow Control Regulators



Metric Miniature Flow Control Regulators

Tube O.D.	Thread	Miniature Flow Control Meter Out - Metric Tube to BSPT or BSPP			Miniature Flow Control Meter In - Metric Tube to BSPT or M5			Knobless Compact Flow Control Meter Out - Metric Tube to BSPP or M5		
		Part No.	Vendor No.	Price	Part No.	Vendor No.	Price	Part No.	Vendor No.	Price
4mm	1/8 BSPT	0450853	7665 04 10	\$14.81	0450854	7668 04 10	\$14.81			
6mm	1/8 BSPT	0451123	7665 06 10	17.94	0451124	7668 06 10	17.94			
6mm	1/4 BSPT	0451109	7665 06 13	17.94	0451110	7668 06 13	17.94			
6mm	3/8 BSPT	0451132	7665 06 17	21.00						
8mm	1/8 BSPT	0451325	7665 08 10	19.06	0451326	7668 08 10	19.06			
8mm	1/4 BSPT	0451315	7665 08 13	19.50	0451314	7668 08 13	19.50			
8mm	3/8 BSPT	0451336	7665 08 17	21.00	0451337	7668 08 17	21.00			
4mm	M5	0442803	7660 04 19	16.56	0450790	7669 04 19	14.06	0450788	7010 04 19	17.75
4mm	1/8 BSPP	0442804	7660 04 10	14.81				0450764	7010 04 10	17.25
6mm	M5	0442805	7660 06 19	17.94	0451048	7669 06 19	17.94	0451047	7010 06 19	21.88
6mm	1/8 BSPP	0442806	7660 06 10	19.59				0451018	7010 06 10	15.63
6mm	1/4 BSPP	0442807	7660 06 13	21.24				0451001	7010 06 13	21.56
8mm	1/8 BSPP	0451221	7660 08 10	19.06				0451220	7010 08 10	15.69
8mm	1/4 BSPP	0451203	7660 08 13	19.50				0451202	7010 08 13	16.00
8mm	3/8 BSPP	0451239	7660 08 17	21.00				0451238	7010 08 17	17.81

Composite Ball Valves



Composite Ball Valves

Composite Ball Valves

Push-to-Connect ports, 3/2, with vent



Tube O.D.	Part No.	Vendor No.	UOM
[5/32]" x 5/32"	0401790	7913 04 00	^
1/4" x 1/4"	0401791	7913 56 00	—
5/16" x 5/16"	0401792	7913 08 00	—
3/8" x 3/8"	0401793	7913 60 00	—

More styles available including metric and Male NPT, please see your Fastenal representative for more details.

In-Line Flow Control (Push-to-Connect Ports)



- Designed to be versatile
- Full flow in both directions
- Fine setting levels secured with use of built in locking nut
- Maybe used individually or stacked together using two joining clips



In-Line Flow Control

In-Line Flow Control (Push-to-Connect Ports) One-Way-Fractional or Metric

Tube O.D.	Part No.	Vendor No.	Price /Each
5/32"	442176	7770 04 00	\$28.38
1/4"	442177	7770 56 00	28.56
5/16"	0442793	7770 08 00	42.83
3/8"	0442789	7770 60 00	43.06
1/2"	0442790	7770 62 00	46.66
6mm	0442792	7770 06 00	42.04
10mm	0442794	7770 10 00	46.16
12mm	0442795	7770 12 00	49.30

The : symbol after a price denotes that it is a Direct Ship Product (DSP) and shipping, availability & lead times may vary.

PUSH-TO-CONNECT SWIFT-FIT INCH & METRIC FITTINGS

Push-to-Connect Swift-Fit Inch & Metric Fittings



SWIFT-FIT Fittings Work With Inch & Metric Threads

Push to Connect Fittings

Features & Benefits

- Fits both inch & metric threads (reduce inventory)
- Exclusive buna thread seal (no thread tape required)
- Nickel-plated brass body (corrosion resistant)
- Lip type tube seal (superior tube sealing)
- Low profile (will fit in confined spaces)

Specifications

Pressure Rating: 0-250 PSI vacuum
Temperature Rating: 0° to 160°F
Media: Compressed air and water
Torque: Minimum 3.7 (ft. pounds) & Maximum 5.2 (ft. pounds)
Tube Sizes: 1/8" - 1/2"; 3 MM to 14 MM
Thread Sizes: 10-32 to 1/2"; M5 to 1/2"; *SWIFT-FIT*
Tubing Types: 90 Durometer; Nylon, Polyurethane, Polyethylene, and Copper

Push-to-Connect *SWIFT-FIT* Inch Fittings



Straight Male Connector



Straight Male - Internal Hex



Female Connector



Swivel Male Elbow



Male Swivel Branch Tee



Male Swivel Run Tee

Tube O.D.	Thread Size	Straight Male Connector			Straight Male - Internal Hex			Female Connector			Swivel Male Elbow			Swivel Male Branch Tee			Swivel Male Run Tee		
		Part No.	Model No.	Price /Each	Part No.	Model No.	Price /Each	Part No.	Model No.	Price /Each	Part No.	Model No.	Price /Each	Part No.	Model No.	Price /Each	Part No.	Model No.	Price /Each
1/8"	10-32	0400044	88020-02-32	\$1.69	68510	87010-02-32	\$3.85				0400047	88115-02-32	\$3.41	0400050	88215-02-32	\$2.88	0400053	88225-02-32	\$4.50
1/8"	1/8"	68440	87000-02-02	2.83				68433	88030-02-02	5.13	68466	87110-02-02	3.90	0443090	87210-02-02	4.15	0443102	87222-02-02	4.15
1/8"	1/4"	0443051	87000-02-04	1.93				0400123	88030-02-04	2.79	0443074	87110-02-04	3.46	0443091	87210-02-04	4.80	0443103	87222-02-04	4.70
5/32	10-32	0400045	88020-53-32	1.77	68511	87010-53-32	3.06				0400048	88115-53-32	2.80				0400054	88225-53-32	4.68
5/32	1/8"	68441	87000-53-02	2.84	0443071	87010-53-02	2.04	68434	88030-53-02	5.90	68467	87110-53-02	4.68	68484	87210-53-02	9.17	68477	87222-53-02	7.91
5/32	1/4"	68442	87000-53-04	8.35				0400124	88030-53-04	2.79	0443089	87110-53-04	3.83	0443101	87210-53-04	7.96	0443113	87222-53-04	7.35
1/4"	10-32	0400046	88020-04-32	1.94	68512	87010-04-32	3.49				0400049	88115-04-32	3.54	0400052	88215-04-32	3.10	0400055	88225-04-32	5.00
1/4"	1/8"	68444	87000-04-02	2.99	0443068	87010-04-02	2.65	68435	88030-04-02	4.98	68468	87110-04-02	5.22	68485	87210-04-02	6.68	68478	87222-04-02	6.34
1/4"	1/4"	68323	87000-04-04	3.58	0443069	87010-04-04	2.73	68436	88030-04-04	5.54	68469	87110-04-04	5.31	68486	87210-04-04	7.03	68479	87222-04-04	6.86
1/4"	3/8"	68445	87000-04-06	4.41							0443077	87110-04-06	4.31	0400040	87210-04-06	3.65			
5/16"	1/8"	68446	87000-05-02	4.59							0443078	87110-05-02	3.70						
5/16"	1/4"	68447	87000-05-04	4.85							0443079	87110-05-04	4.06						
5/16"	3/8"	0443057	87000-05-06	2.96							0443080	87110-05-06	4.91						
3/8"	1/8"	68448	87000-06-02	5.28							0443081	87110-06-02	4.94	0400041	87210-06-02	4.59	0400043	87222-06-02	4.77
1/2"	1/4"	68449	87000-06-04	4.28				68437	88030-06-04	9.88	68470	87110-06-04	6.69	68488	87210-06-04	9.28	68481	87222-06-04	11.19
3/8"	3/8"	68450	87000-06-06	4.75				68438	88030-06-06	8.95	68471	87110-06-06	7.20	0443095	87210-06-06	5.71	0443107	87222-06-06	8.19
3/8"	1/2"	68451	87000-06-08	7.29							0443084	87110-06-08	6.00	0443096	87210-06-08	9.60	0443108	87222-06-08	9.60
1/2"	1/4"	0443062	87000-08-04	3.63							0443085	87110-08-04	4.72	0443097	87210-08-04	9.61	0443109	87222-08-04	9.67
1/2"	3/8"	68452	87000-08-06	7.11							68472	87110-08-06	7.75	68489	87210-08-06	14.52	68482	87222-08-06	12.11
1/2"	1/2"	68453	87000-08-08	8.41							68473	87110-08-08	9.72	68490	87210-08-08	16.13	68483	87222-08-08	13.55

SWIFT-FIT Metric Push-To-Connect Fittings

Tube O.D.	Thread Size	Straight Male Connector			Straight Male Connector (Internal Hex)			Female Connector			Swivel Male Elbow			Swivel Male Branch Tee			Swivel Male Run Tee		
		Part No.	Model No.	Price	Part No.	Model No.	Price	Part No.	Model No.	Price	Part No.	Model No.	Price	Part No.	Model No.	Price	Part No.	Model No.	Price
3mm	M5	0400067	50020N-3-M5	\$1.89	0441375	50010N-3-M5	\$2.88	0400070	50030M-3-M5	\$2.63	0400071	50115N-3-M5	\$3.31	0400074	50215M-3-M5	\$3.69	0400077	50225N-3-M5	\$3.98
4mm	M5	0400068	50020N-4-M5	1.48	0441377	50010N-4-M5	1.85				0441421	50115N-4-M5	3.85	0441445	50215N-4-M5	6.16	0441459	50225N-4-M5	6.32
4mm	1/8	0441367	50000N-4-1/8	1.95	0441376	50010N-4-1/8	1.88	0441383	50030N-4-1/8	2.71	0441413	50110N-4-1/8	3.84	0441439	50210N-4-1/8	5.33	0441453	50222N-4-1/8	5.33
4mm	1/4	0441366	50000N-4-1/4	2.25							0441412	50110N-4-1/4	4.25	0441438	50210N-4-1/4	5.81	0441452	50222N-4-1/4	5.81
5mm	1/8	0441369	50000N-5-1/8	2.27				0441384	50030N-5-1/8	2.71	0441414	50110N-5-1/8	3.93	0441440	50210N-5-1/8	5.33	0441454	50222N-5-1/8	5.33
5mm	1/4	0441368	50000N-5-1/4	2.43															
6mm	M5	0400069	50020N-6-M5	1.55	0441380	50010N-6-M5	2.07				0441422	50115N-6-M5	3.75	0441446	50215N-6-M5	6.16	0441460	50225N-6-M5	6.32
6mm	1/8	0441371	50000N-6-1/8	2.27	0441379	50010N-6-1/8	2.07	0441386	50030N-6-1/8	2.71	0441416	50110N-6-1/8	3.93	0441442	50210N-6-1/8	5.33	0441456	50222N-6-1/8	5.33
6mm	1/4	0441370	50000N-6-1/4	2.43	0441378	50010N-6-1/4	2.33	0441385	50030N-6-1/4	3.13	0441415	50110N-6-1/4	4.25	0441441	50210N-6-1/4	5.81	0441455	50222N-6-1/4	5.81
8mm	1/8	0441373	50000N-8-1/8	2.44	0441382	50010N-8-1/8	2.43	0441388	50030N-8-1/8	3.13	0441419	50110N-8-1/8	4.47	0441444	50210N-8-1/8	6.45	0441458	50222N-8-1/8	6.45
8mm	1/4	0441372	50000N-8-1/4	2.56	0441381	50010N-8-1/4	2.50	0441387	50030N-8-1/4	3.38	0441418	50110N-8-1/4	4.72	0441443	50210N-8-1/4	6.68	0441457	50222N-8-1/4	6.68
8mm	3/8	0441374	50000N-8-3/8	2.88							0441420	50110N-8-3/8	6.04	0400072	50210N-8-3/8	5.69	0400075	50222N-8-3/8	4.97
8mm	1/2	0400064	50000N-8-1/2	2.21							0441417	50110N-8-1/2	6.55	0400073	50210N-8-1/2	6.41	0400076	50222N-8-1/2	5.60
10mm	1/4	0441362	50000N-10-1/4	3.29							0441406	50110N-10-1/4	5.88	0441432	50210N-10-1/4	8.58	0441448	50222N-10-1/4	8.58
10mm	3/8	0441363	50000N-10-3/8	3.35							0441407	50110N-10-3/8	6.55	0441433	50210N-10-3/8	9.07	0441449	50222N-10-3/8	9.07
10mm	1/2	0400065	50000N-10-1/2	2.66							0441405	50110N-10-1/2	7.03	0441431	50210N-10-1/2	9.39	0441447	50222N-10-1/2	9.39
12mm	1/4	0441364	50000N-12-1/4	3.93															
12mm	3/8	0441365	50000N-12-3/8	4.16							0441409	50110N-12-3/8	7.35	0441435	50210N-12-3/8	9.78	0441451	50222N-12-3/8	9.78
12mm	1/2	0400066	50000N-12-1/2	3.15							0441408	50110N-12-1/2	8.05	0441434	50210N-12-1/2	10.69	0441450	50222N-12-1/2	10.69

PUSH-TO-CONNECT SWIFT-FIT INCH & METRIC FITTINGS

Push-to-Connect Swift-Fit Inch & Metric Fittings Cont.



Inch Tube Fittings



Tube Union



Bulkhead Union



Union Elbow



Union Tee



Plug



Union Y

Tube O.D.	Tube Union			Bulkhead Union			Union Elbow			Union Tee			Plug			Union Y		
	Part No.	Model No.	Price /Each	Part No.	Model No.	Price /Each	Part No.	Model No.	Price /Each	Part No.	Model No.	Price /Each	Part No.	Model No.	Price /Each	Part No.	Model No.	Price /Each
1/8"	68422	88040-02	\$4.15	68498	88050-02	\$5.59	0443126	88130-02	\$3.25	69585	88230-02	\$7.06	68504	88610-02	\$1.54	0443138	88310-02	\$4.56
5/32"	68423	88040-53	4.82	68499	88050-53	4.85	68428	88130-53	4.47	69365	88230-53	6.04	68505	88610-53	1.35	0443141	88310-53	5.56
1/4"	68424	88040-04	5.02	68500	88050-04	7.16	68429	88130-04	6.08	69366	88230-04	6.04	68506	88610-04	1.35	0443139	88310-04	6.23
5/16"	68425	88040-05	5.16	68501	88050-05	5.94	68430	88130-05	6.69	69367	88230-05	6.47	68507	88610-05	2.77	0443140	88310-05	6.28
3/8"	68426	88040-06	7.86	68502	88050-06	9.02	68431	88130-06	9.02	69368	88230-06	9.30	68508	88610-06	2.27	0400056	88310-06	8.26
1/2"	68427	88040-08	8.56	68503	88050-08	11.34	68432	88130-08	13.48	69369	88230-08	12.00	68509	88610-08	3.05			

Metric Tube Fittings



Tube Union



Bulkhead Union



Union Elbow



Union Tee



Union Y

Tube O.D.	Tube Union			Bulkhead Union			Union Elbow			Union Tee			Union Y		
	Part No.	Model No.	Price	Part No.	Model No.	Price	Part No.	Model No.	Price	Part No.	Model No.	Price	Part No.	Model No.	Price
3mm	0441392	50040N-3	\$5.04				0441426	50130N-3	\$5.04	0441464	50230N-3	\$7.09	0441469	50310N-3	\$9.45
4mm	0441393	50040N-4	3.55	0441401	50050N-4	5.33	0441427	50130N-4	3.93	0441465	50230N-4	5.40	0441470	50310N-4	7.60
5mm	0441394	50040N-5	3.61	0441402	50050N-5	5.91	0441428	50130N-5	3.94	0441466	50230N-5	5.85	0441471	50310N-5	7.92
6mm	0441395	50040N-6	3.61	0441403	50050N-6	5.91	0441429	50130N-6	3.99	0441467	50230N-6	5.85	0441472	50310N-6	7.41
8mm	0441397	50040N-8	3.99	0441404	50050N-8	6.52	0441430	50130N-8	4.64	0441468	50230N-8	6.68	0441473	50310N-8	9.01
10mm	0441389	50040N-10	5.04	0441399	50050N-10	8.50	0441423	50130N-10	5.72	0441461	50230N-10	8.69			
12mm	0441390	50040N-12	5.88	0441400	50050N-12	10.31	0441424	50130N-12	7.47	0441462	50230N-12	10.44			

Fixed Elbow



Fixed Elbow

Tube O.D.	Thread Size	Part No.	Model No.	Price /Each
1/4	1/8 NPTF	68458	88100-04-02	\$2.50
1/4	1/4 NPTF	68459	88100-04-04	3.97
3/8	1/4 NPTF	68462	88100-06-04	5.80
3/8	3/8 NPTF	68463	88100-06-06	7.02

Reducer



Reducer

Tube O.D.	Stud	Part No.	Model No.	Price /Each
1/8	1/4	68513	88700-04-02	\$4.49
5/32	1/4	68515	88700-04-53	5.50
1/4	3/8	68519	88700-06-04	6.23
1/4	1/2	68521	88700-08-04	6.57
3/8	1/2	68522	88700-08-06	8.25

FITTINGS SIMPLIFIED

ALPHA
FITTINGS & ACCESSORIES

SWIFT-FIT MULTI-SOCKET
PUSH-IN FITTINGS COMPATIBLE WITH INCH & METRIC THREAD TYPES
UNIVERSAL QUICK COUPLER COMPATIBLE WITH MULTIPLE PLUG TYPES

Push to Connect Fittings

"SWIFT-FIT" INCH & INLINE FLOW CONTROLS, VALVES

"Swift-Fit" Inch Flow Controls & Needle Valves



SWIFT-FIT Inch Flow Controls & Needle Valves

Features & Benefits

- Fits both inch & metric threads
- Nickel-plated brass body
- Low profile construction
- Captured stem to prevent blow-out

Specifications

Operating Pressure: 0-150 PSI (non-shock)

Media: Air, water, oil

Controlled Flow: In, Out, Bi-directional (Both)

Adjustments: Screw or knob



Screw Adjustment

Tube O.D.	Thread Size	Flow Out		Flow In		Flows Both	
		Part No.	Price /Each	Part No.	Price /Each	Part No.	Price /Each
1/8	1/8	0443155	\$12.44	0443171	\$12.86	0443187	\$11.11
1/8	10-32	0443156	15.12	0443172	16.21	0443188	13.27
5/32	1/8	0443159	12.44	0443175	12.86	0443191	11.76
5/32	10-32	0443160	15.12	0443176	16.21	0443192	13.33
1/4	1/8	0443157	12.44	0443173	13.05	0443189	11.11
1/4	1/4	0443158	14.81	0443174	14.42	0443190	12.71
3/8	3/8	0443003	21.15	0443006	21.15	0443009	21.15
1/2	3/8	0443004	26.59	0443007	26.59	0443010	26.59
1/2	1/2	0443005	28.03	0443008	28.02	0443011	28.03



Knob Adjustment

Tube O.D.	Thread Size	Flow Out		Flow In		Flows Both	
		Part No.	Price /Each	Part No.	Price /Each	Part No.	Price /Each
1/8	1/8	0443163	\$13.22	0443179	\$13.67	0443195	\$12.35
1/8	10-32	0443164	16.76	0443180	17.37	0443196	13.61
5/32	1/8	0443167	13.22	0443183	14.15	0443199	12.35
5/32	10-32	0443168	16.76	0443184	17.37	0443200	13.36
1/4	1/8	0443165	14.15	0443181	13.67	0443197	12.35
1/4	1/4	0443166	16.21	0443182	16.21	0443198	13.78
3/8	3/8	0443012	20.84	0443015	21.58	0443018	21.58
1/2	3/8	0443013	21.99	0443016	21.99	0443019	21.99
1/2	1/2	0443014	28.58	0443017	28.58	0443020	27.59



Screw Adjustment (female)

Thread Size	Flow Out		Flows Both	
	Part No.	Price /Each	Part No.	Price /Each
1/8"	0443153	\$14.44	0443185	\$13.35
1/4"	0443154	15.61	0443186	13.83
3/8"	0443021	21.15	0443023	21.15



Knob Adjustment (female)

Thread Size	Flow Out		Flow In		Flows Both	
	Part No.	Price /Each	Part No.	Price /Each	Part No.	Price /Each
1/8	0443161	\$13.88	0443177	\$13.35	0443193	\$13.33
1/4	0443162	13.88	0443178	13.83	0443194	13.88
3/8	0443024	21.25	0443025	21.25	0443026	23.89

Inline Flow Controls & Needle Valves

Inline Flow Controls & Needle Valves

Specifications

- Aluminum body
- Brass stem panel mount standard

Operating Pressure: 0-150 PSI (non-shock)

Media: Air, water, oil



Thread Size	Flow Controls		Needle Valves	
	Part No.	Price /Each	Part No.	Price /Each
1/8 NPTF	0443201	\$9.52	0443205	\$9.50
1/4 NPTF	0443202	12.60	0443206	12.49
3/8 NPTF	0443203	24.42	0443207	24.41
1/2 NPTF	0443204	27.91		

Pneumatic Accessories

Check Valve

- Operating Pressure: 0-120 psi
- Temperature Range: 0-160° F



Check Valve

Slide Valve

- Operating Pressure: 0-150 psi
- Temperature Range: 0-160° F



Quick Exhaust Valve

Quick Exhaust Valve

- Operating Pressure: 0-150 psi
- Temperature Range: 0-160° F



Slide Valve

Thread Size	Check Valve Female NPTF		Slide Valve Female NPTF		Quick Exhaust Valve Female NPTF	
	Part No.	Price /Each	Part No.	Price /Each	Part No.	Price /Each
1/8 NPTF	0443037	\$8.25	0443033	\$13.43	0443027	\$10.51
1/4 NPTF	0443038	8.24	0443034	16.38	0443028	12.90
3/8 NPTF			0443035	20.38	0443029	15.20
1/2 NPTF			0443036	25.81	0443030	21.75
3/4 NPTF					0443031	24.66
1 NPTF					0443032	142.14

Mini Ball Valves

Mini Ball Valves

- Chrome plated brass body & ball
- High flow
- Captured stem
- Compact size

Operating Pressure: Vacuum to 250 PSI

Media: Air, oil, water



Female x Female



Male x Female



Tube x Tube

Thread Size	Female x Female		Male x Female		Tube x Tube	
	Part No.	Price /Each	Part No.	Price /Each	Part No.	Price /Each
1/8 NPTF	0443039	\$6.24	0443043	\$6.05	0443047	\$10.73
1/4 NPTF	0443040	6.40	0443044	6.67	0443048	10.45
3/8 NPTF	0443041	6.95	0443045	6.40	0443049	11.66
1/2 NPTF	0443042	9.73	0443046	9.73		

SWIFT FIT FITTING KITS

Swift Fit Fittings Kits



1/4" Tube Kit Part #0443209



Part No.	Description	Price /Each
0443209	1/4" Tube Kit	\$183.95

Kit contains the following push-to-connects:

Tube O.D.	Thread Size	Part No.	Description	Pkg. Qty.
1/4"	1/8"	68444	Straight Male Connector	5
1/4"	1/4"	68323	Straight Male Connector	10
1/4"	3/8"	68445	Straight Male Connector	3
1/4"	1/8"	68468	Swivel Male Elbow	5
1/4"	1/4"	68469	Swivel Male Elbow	10
1/4"	3/8"	0443077	Swivel Male Elbow	3
1/4"	1/8"	68485	Swivel Male Branch Tee	3
1/4"	1/4"	68486	Swivel Male Branch Tee	6
1/4"		68424	Tube Union	2
1/4"		68429	Union Elbow	6
1/4"		69366	Union Tee	2

3/8" Tube Kit Part #0443210



Part No.	Description	Price /Each
0443210	3/8" Tube Kit	\$220.89

Kit contains the following push-to-connects:

Tube O.D.	Thread Size	Part No.	Description	Pkg. Qty.
1/2"	1/4"	68449	Straight Male Connector	3
3/8"	3/8"	68450	Straight Male Connector	6
3/8"	1/2"	68451	Straight Male Connector	5
3/8"	1/4"	68470	Swivel Male Elbow	3
3/8"	3/8"	68471	Swivel Male Elbow	6
3/8"	1/2"	0443084	Swivel Male Elbow	5
3/8"	1/4"	68488	Swivel Male Branch Tee	2
3/8"	3/8"	0443095	Swivel Male Branch Tee	2
3/8"	1/2"	0443096	Swivel Male Branch Tee	2
3/8"		68426	Tube Union	2
3/8"		68431	Union Elbow	3
3/8"		69368	Union Tee	2

1/2" Tube Kit Part #0443211



Part No.	Description	Price /Each
0443211	1/2" Tube Kit	\$261.15

Kit contains the following push-to-connects:

Tube O.D.	Thread Size	Part No.	Description	Pkg. Qty.
1/2"	1/4"	0443062	Straight Male Connector	3
1/2"	3/8"	68452	Straight Male Connector	5
1/2"	1/2"	68453	Straight Male Connector	6
1/2"	1/4"	0443085	Swivel Male Elbow	3
1/2"	3/8"	68472	Swivel Male Elbow	5
1/2"	1/2"	68473	Swivel Male Elbow	6
1/2"	1/4"	0443097	Swivel Male Branch Tee	2
1/2"	3/8"	68489	Swivel Male Branch Tee	2
1/2"	1/2"	68490	Swivel Male Branch Tee	2
1/2"		68427	Tube Union	2
1/2"		68432	Union Elbow	3
1/2"		69369	Union Tee	2

Mixed Tube Size Kit Part #0443212



Part No.	Description	Price /Each
0443212	Mixed Tube Size Kit	\$411.50

Kit contains the following push-to-connects:

Tube O.D.	Thread Size	Part No.	Description	Pkg. Qty.
1/4"	1/4"	68323	Straight Male Connector	10
1/4"	1/4"	68469	Swivel Male Elbow	10
1/4"	1/4"	68486	Swivel Male Branch Tee	6
1/4"		68424	Tube Union	2
1/4"		68429	Union Elbow	6
1/4"		69366	Union Tee	2
3/8"	3/8"	68450	Straight Male Connector	6
3/8"	3/8"	68471	Swivel Male Elbow	6
3/8"	3/8"	0443095	Swivel Male Branch Tee	2
3/8"		68426	Tube Union	2
3/8"		68431	Union Elbow	3
3/8"		69368	Union Tee	2
1/2"	1/2"	68453	Straight Male Connector	6
1/2"	1/2"	68473	Swivel Male Elbow	6
1/2"	1/2"	68490	Swivel Male Branch Tee	2
1/2"		68427	Tube Union	2
1/2"		68432	Union Elbow	3
1/2"		69369	Union Tee	2

6MM Tube Kit Part # 0441480



Part No.	Description	Price /Each
0441480	6mm Tube Fitting Kit	\$386.79

Kit contains the following push-to-connects:

Tube O.D.	Thread Size	Part No.	Description	Pkg. Qty.
6mm	M5	0441380	Straight Male Connector (Internal Hex)	5
6mm	1/8"	0441371	Straight Male Connector	5
6mm	1/4"	0441370	Straight Male Connector	10
6mm	1/8"	0441416	Swivel Male Elbow	5
6mm	1/4"	0441415	Swivel Male Elbow	10
6mm	M5	0441422	Swivel Male Elbow	5
6mm	1/8"	0441442	Swivel Male Branch Tee	5
6mm	1/4"	0441441	Swivel Male Branch Tee	10
6mm		0441429	Union Elbow	5
6mm		0441395	Tube Union	5
6mm		0441467	Union Tee	5

8MM Tube Kit Part # 0441481



Part No.	Description	Price /Each
0441481	8mm Tube Fitting Kit	\$370.02

Kit contains the following push-to-connects:

Tube O.D.	Thread Size	Part No.	Description	Pkg. Qty.
8mm	1/8"	0441373	Straight Male Connector	5
8mm	1/4"	0441372	Straight Male Connector	10
8mm	3/8"	0441374	Straight Male Connector	10
8mm	1/4"	0441418	Swivel Male Elbow	10
8mm	3/8"	0441420	Swivel Male Elbow	5
8mm	1/2"	0441417	Swivel Male Elbow	5
8mm	1/8"	0441444	Swivel Male Branch Tee	3
8mm	1/4"	0441443	Swivel Male Branch Tee	3
8mm		0441430	Union Elbow	3
8mm		0441397	Tube Union	3
8mm		0441468	Union Tee	3

Push to Connect
Fittings

BRASS PUSH-TO-CONNECT (POLY-PUSH) FITTINGS

Thermoplastic Tubing

Brass Push-To-Connect (Poly-Push) Fittings

F.T.N | Weatherhead

These fittings are nickel-plated Brass; Silver in color. Push-To-Connect fittings are used with thermoplastic tubing only.

Cartridge

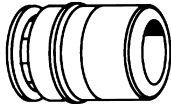

Tube O.D.	Vendor No.	Part No.	Price /Each
1/8	1161X2	440954-131280	\$3.48
5/32	1161X2.5	440955-131280	4.17
1/4	1161X4	440956-131280	3.54
5/16	1161X5	440957-131280	4.64
3/8	1161X6	440958-131280	4.40
1/2	1161X8	440959-131280	5.13

Plug (Plastic)

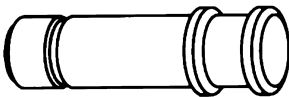

Tube O.D.	Vendor No.	Part No.	Price /Each
1/8	1129X2	440960-131280	\$1.92
5/32	1129X2.5	440961-131280	1.58
1/4	1129X4	440962-131280	1.65
5/16	1129X5	440963-131280	1.90
3/8	1129X6	440964-131280	1.98
1/2	1129X8	440965-131280	3.38

Union (For Joining Tubing)



Tube O.D.	Vendor No.	Part No.	Price /Each
1/8	1162X2	440966-131280	\$4.28
5/32	1162X2.5	440967-131280	4.05
1/4	1162X4	440968-131280	4.81
5/16	1162X5	440969-131280	5.40
3/8	1162X6	440970-131280	6.66
1/2	1162X8	440971-131280	9.31

Double Union (For Joining Push-To-Connect Fittings)



Tube O.D.	Vendor No.	Part No.	Price /Each
1/8	1105X2	440972-131280	\$1.55
5/32	1105X2.5	440973-131280	5.12
1/4	1105X4	440974-131280	1.97
5/16	1105X5	440975-131280	1.94
3/8	1105X6	440976-131280	3.32
1/2	1105X8	440977-131280	4.52

Reducer

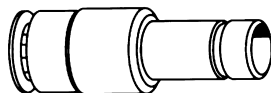

Tube O.D.	Vendor No.	Part No.	Price /Each
1/8 x1/4	1109X2X4	440978-131280	\$5.02
5/32 x1/4	1109X2.5X4	440979-131280	4.18
1/4 x3/8	1109X4X6	440980-131280	5.35
1/4 x1/2	1109X4X8	440981-131280	4.93
3/8 x1/2	1109X6X8	440982-131280	6.01

Stem Adapter

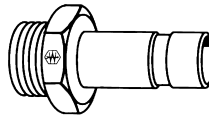

Tube O.D.	MPT	Vendor No.	Part No.	Price /Each
1/8	1/8	1180X2	440983-131280	\$2.40
1/8	1/4	1180X2X4	440984-131280	2.38
5/32	1/8	1180X2.5	440985-131280	3.10
5/32	1/4	1180X2.5X4	440986-131280	3.60
1/4	1/8	1180X4	440987-131280	3.32
1/4	1/4	1180X4X4	440988-131280	2.38
5/16	1/8	1180X5	440989-131280	2.66
5/16	1/4	1180X5X4	440990-131280	3.25
3/8	1/4	1180X6	440991-131280	4.02
3/8	3/8	1180X6X6	440992-131280	3.47
1/2	3/8	1180X8	440993-131280	3.17
1/2	1/2	1180X8X8	440994-131280	5.57

Bulkhead Union

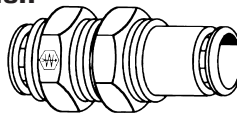

Tube O.D.	Vendor No.	Part No.	Price /Each
1/8	1174X2	440995-131280	\$5.13
5/32	1174X2.5	440996-131280	4.89
1/4	1174X4	440997-131280	5.72
5/16	1174X5	440998-131280	6.47
3/8	1174X6	440999-131280	9.09
1/2	1174X8	441000-131280	13.90

Union "Y"

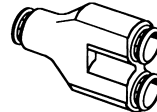

Tube O.D.	Vendor No.	Part No.	Price /Each
1/8	1107X2	441001-131280	\$12.54
5/32	1107X2.5	441002-131280	11.19
1/4	1107X4	441003-131280	17.97

Male Swivel "Y"

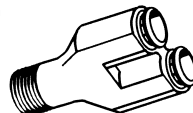

Tube O.D.	MPT	Vendor No.	Part No.	Price /Each
1/8	10-32	1108X2A	441004-131280	\$11.90
1/8	1/8	1108X2	441005-131280	9.37
5/32	1/8	1108X2.5	441006-131280	12.66
1/4	1/8	1108X4	441007-131280	10.41

Female Connector

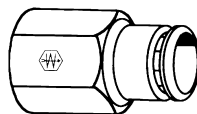

Female Connector

Tube O.D.	FPT	Vendor No.	Part No.	Price /Each
1/8	1/8	1166X2	441008-131280	\$5.88
1/8	1/4	1166X2X4	441009-131280	8.02
5/32	1/8	1166X2.5	441010-131280	6.76
5/32	1/4	1166X2.5X4	441011-131280	9.00
1/4	1/8	1166X4	441012-131280	6.26
1/4	1/4	1166X4X4	441013-131280	6.72
3/8	1/4	1166X6	441014-131280	8.58
3/8	3/8	1166X6X6	441015-131280	6.16

Knurled Male Connector

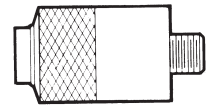

Tube O.D.	MPT	Part No.	Price /Each
1/8	10-32	68510	\$3.85
5/32	10-32	68511	3.06
1/4	10-32	68512	3.49

Male Connector

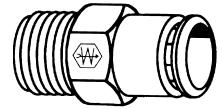

Tube O.D.	MPT	Vendor No.	Part No.	Price /Each
1/8	10-32	1168X2A	441016-131280	\$3.34
1/8	1/8	1168X2	441017-131280	2.83
1/8	1/4	1168X2X4	441018-131280	2.45
5/32	10-32	1168X2.5A	441019-131280	4.00
5/32	1/8	1168X2.5	441020-131280	4.12
5/32	1/4	1168X2.5X4	441021-131280	3.99
1/4	10-32	1168X4A	441022-131280	4.38
1/4	1/8	1168X4	441023-131280	3.00
1/4	1/4	1168X4X4	441024-131280	3.22
1/4	3/8	1168X4X6	441025-131280	3.55
5/16	1/8	1168X5	441026-131280	4.49
5/16	1/4	1168X5X4	441027-131280	4.72
5/16	3/8	1168X5X6	441028-131280	5.23
3/8	1/8	1168X6X2	441029-131280	6.05
3/8	1/4	1168X6	441030-131280	6.64
3/8	3/8	1168X6X6	441031-131280	5.41
3/8	1/2	1168X6X8	441032-131280	7.25
1/2	3/8	1168X8	441033-131280	8.82
1/2	1/2	1168X8X8	441034-131280	9.82

90° Union Elbow

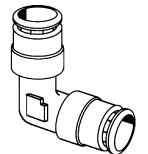

Tube O.D.	Vendor No.	Part No.	Price /Each
1/8	1165X2	441035-131280	\$4.77
5/32	1165X2.5	441036-131280	5.11
1/4	1165X4	441037-131280	5.39
5/16	1165X5	441038-131280	7.78
3/8	1165X6	441039-131280	8.14
1/2	1165X8	441040-131280	9.45

90° Male Elbow (No Swivel)

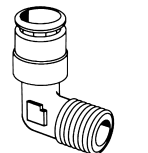

Fixed Elbow

Tube O.D.	MPT	Vendor No.	Part No.	Price /Each
1/4	1/8	1169X4	441041-131280	\$4.31
1/4	1/4	1169X4X4	441042-131280	4.61
3/8	1/4	1169X6	441043-131280	6.95
3/8	3/8	1169X6X6	441044-131280	7.32

BRASS INCH AND METRIC PUSH-TO-CONNECT, FLOW CONTROLS

Brass Push-To-Connect (Poly-Push) Fittings Cont.

F.T.N | Weatherhead

90° Male Elbow (Swivel)

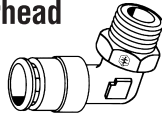

Tube O.D.	MPT	Vendor No.	Part No.	Price /Each
1/8	10-32	1169X2AS	441045-131280	\$8.92
1/8	1/8	1169X2S	441046-131280	5.13
1/8	1/4	1169X2X4S	441047-131280	5.12
5/32	10-32	1169X2.5AS	441048-131280	7.73
5/32	1/8	1169X2.5S	441049-131280	4.67
5/32	1/4	1169X2.5X4S	441050-131280	5.49
1/4	1/8	1169X4S	441051-131280	4.95
1/4	1/4	1169X4X4S	441052-131280	5.74
1/4	3/8	1169X4X6S	441053-131280	8.55
5/16	1/8	1169X5S	441054-131280	6.14
5/16	1/4	1169X5X4S	441055-131280	6.45
5/16	3/8	1169X5X6S	441056-131280	8.62
3/8	1/4	1169X6S	441057-131280	8.18
3/8	3/8	1169X6X6S	441058-131280	8.55
3/8	1/2	1169X6X8S	441059-131280	9.63
1/2	1/4	1169X8X4S	441060-131280	11.61
1/2	3/8	1169X8S	441061-131280	10.09
1/2	1/2	1169X8X8S	441062-131280	13.14

90° Female Elbow

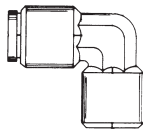

Tube O.D.	FPT	Part No.	Price /Each
1/4	1/8	68475	\$6.00
3/8	1/4	68476	8.49

Union Tee

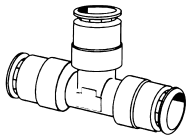

Tube O.D.	Vendor No.	Part No.	Price /Each
1/8	1164X2	441063-131280	\$5.88
5/32	1164X2.5	441064-131280	8.15
1/4	1164X4	441065-131280	6.43
5/16	1164X5	441066-131280	6.18
3/8	1164X6	441067-131280	10.56
1/2	1164X8	441068-131280	13.23

Male Run Tee (Swivel)

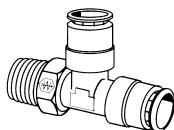

Tube O.D.	MPT	Vendor No.	Part No.	Price /Each
1/8	10-32	1171X2AS	441069-131280	\$8.98
1/8	1/8	1171X2S	441070-131280	6.90
5/32	10-32	1171X2.5AS	441071-131280	9.00
5/32	1/8	1171X2.5S	441072-131280	8.25
5/32	1/4	1171X2.5X4S	441073-131280	8.65
1/4	1/8	1171X4S	441074-131280	7.18
1/4	1/4	1171X4X4S	441075-131280	7.41
1/4	3/8	1171X4X6S	441076-131280	10.04
3/8	1/4	1171X6S	441077-131280	11.65
3/8	3/8	1171X6X6S	441078-131280	13.69
3/8	1/2	1171X6X8S	441079-131280	18.99
1/2	1/4	1171X8X4S	441080-131280	16.92
1/2	3/8	1171X8S	441081-131280	16.44
1/2	1/2	1171X8X8S	441082-131280	22.49

Male Branch Tee (Swivel)

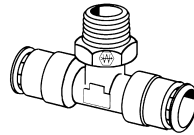

Tube O.D.	MPT	Vendor No.	Part No.	Price /Each
1/8	10-32	1172X2AS	441083-131280	\$8.98
1/8	1/8	1172X2S	441084-131280	6.94
5/32	10-32	1172X2.5AS	441085-131280	8.83
5/32	1/8	1172X2.5S	441086-131280	8.65
5/32	1/4	1172X2.5X4S	441087-131280	7.35
1/4	1/8	1172X4S	441088-131280	8.16
1/4	1/4	1172X4X4S	441089-131280	8.33
1/4	3/8	1172X4X6S	441090-131280	11.44
3/8	1/4	1172X6S	441091-131280	11.38
3/8	3/8	1172X6X6S	441092-131280	15.38
3/8	1/2	1172X6X8S	441093-131280	14.98
1/2	1/4	1172X8X4S	441094-131280	17.49
1/2	3/8	1172X8S	441095-131280	14.98
1/2	1/2	1172X8X8S	441096-131280	17.77

Push-To-Connect: Flow Controls

F.T.N | Weatherhead

SCU (Tube)

Flow controls come unidirectional or bidirectional. Small size allows for direct mounting on valves or cylinders.

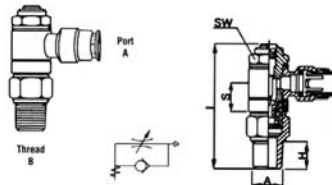

Tube O.D.	NPTF	Vendor No.	Part No.	Price /Each
5/32	1/8	A55SCU x 2.5 x 2	441314-131280	\$31.63
1/4	1/8	A55SCU x 4 x 2	441315-131280	25.16
1/4	1/4	A55SCU x 4 x 4	441316-131280	26.37
3/8	1/4	A55SCU x 6 x 4	441317-131280	26.57
3/8	3/8	A55SCU x 6 x 6	441318-131280	43.70

SCU (Banjo-Female)

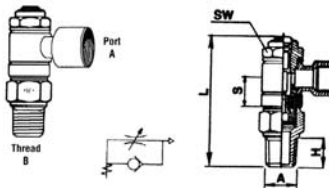

Female Thread	NPTF	Vendor No.	Part No.	Price /Each
1/8 Banjo	1/8	A557SCU x 2 x 2	441320-131280	\$32.59
1/4 Banjo	1/4	A557SCU x 4 x 4	441321-131280	34.49
3/8 Banjo	3/8	A557SCU x 6 x 6	441322-131280	47.05

MCU (Banjo-Female)

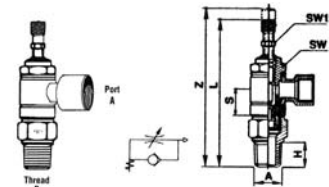

Tube O.D.	NPTF	Vendor No.	Part No.	Price /Each
1/8	1/8	A557MCU x 2 x 2	441323-131280	\$32.98
3/8	3/8	A557MCU x 6 x 6	441324-131280	54.26

Brass Metric Push-To-Connect

F.T.N | Weatherhead

Plug (Plastic)

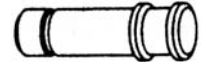

Tube O.D. (mm)	Vendor No.	Part No.	Price /Each
4	1129X4MRP	441126-131280	\$1.78
5	1129X5MRP	441127-131280	1.92
6	1129X6MRP	441128-131280	1.56
8	1129X8MRP	441129-131280	1.92
10	1129X10MRP	441130-131280	2.40
12	1129X12MRP	441131-131280	3.04

Double Union

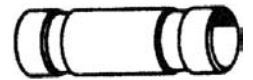

Tube O.D. (mm)	Vendor No.	Part No.	Price /Each
4	1105X4M	441132-131280	\$1.70
6	1105X6M	441134-131280	2.01
8	1105X8M	441135-131280	2.97
10	1105X10M	441136-131280	4.25

Joins Push Connect Fittings

Reducer

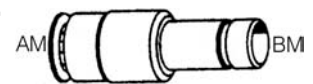

Tube O.D. (Am x Bm)	Vendor No.	Part No.	Price /Each
4 x 6	1109X4MX6M	441139-131280	\$3.17
6 x 8	1109X6MX8M	441143-131280	4.08
6 x 10	1109X6MX10M	441144-131280	5.01
8 x 10	1109X8MX10M	441146-131280	5.46
8 x 12	1109X8MX12M	441147-131280	6.56

Union



Tube O.D. (mm)	Vendor No.	Part No.	Price /Each
4	1162X4M	441149-131280	\$9.08
5	1162X5M	441150-131280	6.23
6	1162X6M	441151-131280	5.76
8	1162X8M	441152-131280	6.64
10	1162X10M	441153-131280	8.43
12	1162X12M	441154-131280	8.59

Bulkhead Union

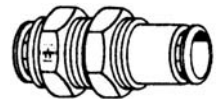

Tube O.D. (mm)	Vendor No.	Part No.	Price /Each
4	1174X4M	441164-131280	\$7.03
5	1174X5M	441165-131280	13.64
6	1174X6M	441166-131280	10.14
8	1174X8M	441167-131280	10.69
10	1174X10M	441168-131280	11.95
12	1174X12M	441169-131280	16.91

Union "Y"

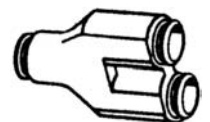

Tube O.D. (mm)	Vendor No.	Part No.	Price /Each
4	1107X4M	441170-131280	\$13.34
5	1107X5M	441171-131280	8.40
6	1107X6M	441172-131280	11.03
8	1107X8M	441173-131280	20.15

Push to Connect Fittings

BRASS METRIC PUSH-TO-CONNECT, POLYURETHANE TUBING

Brass Metric Push-To-Connect

F.T.N | Weatherhead

Male Connector (BSPT)

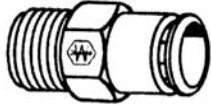

Tube O.D.	Thread	Vendor No.	Part No.	Price /Each
4mm	1/8 BSPT	1168X4MX2PT	441176-131280	\$3.01
4mm	1/4 BSPT	1168X4MX4PT	441177-131280	3.01
5mm	1/8 BSPT	1168X5MX2PT	441178-131280	3.02
5mm	1/4 BSPT	1168X5MX4PT	441179-131280	3.00
6mm	1/8 BSPT	1168X6MX2PT	441180-131280	3.22
6mm	1/4 BSPT	1168X6MX4PT	441181-131280	3.60
8mm	1/8 BSPT	1168X8MX2PT	441182-131280	3.69
8mm	1/4 BSPT	1168X8MX4PT	441183-131280	3.78
8mm	3/8 BSPT	1168X8MX6PT	441184-131280	4.34
10mm	1/4 BSPT	1168X10MX2PT	441185-131280	8.12
10mm	3/8 BSPT	1168X10MX4PT	441186-131280	6.53
10mm	1/2 BSPT	1168X10MX6PT	441187-131280	6.19
12mm	1/4 BSPT	1168X12MX4PT	441188-131280	6.64
12mm	3/8 BSPT	1168X12MX6PT	441189-131280	5.52
12mm	1/2 BSPT	1168X12MX8PT	441190-131280	7.10

Female Connector (BSPP)

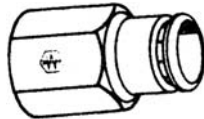

Tube O.D.	Thread	Vendor No.	Part No.	Price /Each
4mm	1/8 BSPP	1166X4MX2PP	441197-131280	\$5.95
6mm	1/8 BSPP	1166X6MX2PP	441201-131280	4.13
6mm	1/4 BSPP	1166X6MX4PP	441202-131280	5.05
8mm	1/8 BSPP	1166X8MX2PP	441203-131280	6.78
8mm	1/4 BSPP	1166X8MX4PP	441204-131280	5.34
10mm	1/4 BSPP	1166X10MX4PP	441205-131280	9.56

90° Union Elbow



Tube O.D. (mm)	Vendor No.	Part No.	Price /Each
4	1165X4M	441206-131280	\$5.30
5	1165X5M	441207-131280	8.54
6	1165X6M	441208-131280	6.33
8	1165X8M	441209-131280	7.57
10	1165X10M	441210-131280	9.35
12	1165X12M	441211-131280	13.18

90° Male Elbow (BSPT)



Tube O.D.	Thread	Vendor No.	Part No.	Price /Each
4mm	1/8 BSPT	1169X4MX2PT	441212-131280	\$5.20
4mm	1/4 BSPT	1169X4MX4PT	441213-131280	8.63
5mm	1/8 BSPT	1169X5MX2PT	441214-131280	7.62
5mm	1/4 BSPT	1169X5MX4PT	441215-131280	10.20
6mm	1/8 BSPT	1169X6MX2PT	441216-131280	4.26
6mm	1/4 BSPT	1169X6MX4PT	441217-131280	4.45
8mm	1/8 BSPT	1169X8MX2PT	441218-131280	5.05
8mm	1/4 BSPT	1169X8MX4PT	441219-131280	6.15
8mm	3/8 BSPT	1169X8MX6PT	441220-131280	10.97
10mm	1/4 BSPT	1169X10MX4PT	441221-131280	8.99
10mm	3/8 BSPT	1169X10MX6PT	441222-131280	7.80
12mm	1/4 BSPT	1169X12MX4PT	441223-131280	12.50
12mm	3/8 BSPT	1169X12MX6PT	441224-131280	11.46

90° Male Elbow Swivel Universal (BSPT)



Tube O.D.	Thread	Vendor No.	Part No.	Price /Each
4mm	1/8 BSPT	1169X4MX2PTS	441225-131280	\$7.56
5mm	1/8 BSPT	1169X5MX2PTS	441226-131280	6.06
5mm	1/4 BSPT	1169X5MX4PTS	441227-131280	7.62
6mm	1/8 BSPT	1169X6MX2PTS	441228-131280	8.74
6mm	1/4 BSPT	1169X6MX4PTS	441229-131280	6.65
8mm	1/8 BSPT	1169X8MX2PTS	441230-131280	10.12
8mm	1/4 BSPT	1169X8MX4PTS	441231-131280	9.77
8mm	3/8 BSPT	1169X8MX6PTS	441232-131280	10.13
10mm	1/4 BSPT	169X10MX4PTS	441233-131280	12.40
10mm	3/8 BSPT	169X10MX6PTS	441234-131280	13.10
10mm	1/2 BSPT	169X10MX8PTS	441235-131280	11.18
12mm	1/4 BSPT	169X12MX4PTS	441236-131280	14.54
12mm	3/8 BSPT	169X12MX6PTS	441237-131280	16.10
12mm	1/2 BSPT	169X12MX8PTS	441238-131280	13.77

Swivel for installation purposes only.

Thermoplastic Tubing



Polyurethane Tubing (Fractional)

- The most flexible thermoplastic tubing available
- Great abrasion and kink resistance
- 98A durometer
- Perfect for push-to-connect fittings
- High degree of dimensional stability
- Ether based material provides excellent resistance to moisture, oil, and cold

Part No.	Vendor No.	ID	OD	Coil Length	Color	Price /Roll
0448260	PU18AC	.062	1/8"	100	Clear	\$21.38
0448261	PU18ABK	.062	1/8"	100	Black	21.38
0448264	PU18ANB	.062	1/8"	100	Navy Blue	21.38
0448263	PU18AR	.062	1/8"	100	Red	21.38
0448740	PU18CC	.062	1/8"	500	Clear	98.94
0448345	PU532AC	.093	5/32	100	Clear	23.89
0448346	PU532ABK	.093	5/32	100	Black	23.89
0448349	PU532ANB	.093	5/32	100	Navy Blue	23.89
0448336	PU532ACB	.093	5/32	100	Translucent Blue	23.89
0448330	PU532AR	.093	5/32	100	Red	23.89
0448352	PU532ACR	.093	5/32	100	Translucent Red	23.89
0448333	PU532AOR	.093	5/32	100	Orange	23.89
0448347	PU532AG	.093	5/32	100	Green	23.89
0448350	PU532AY	.093	5/32	100	Yellow	23.89
0448829	PU532CBK	.093	5/32	500	Black	107.50
0448209	PU14AC	.156	1/4	100	Clear	42.76
0448226	PU14ABK	.156	1/4	100	Black	42.76
0448229	PU14ANB	.156	1/4	100	Navy Blue	42.76
0448712	PU14ACB	.156	1/4	100	Translucent Blue	42.76
0448228	PU14AR	.156	1/4	100	Red	42.76
0448231	PU14ACR	.156	1/4	100	Translucent red	42.76
0448227	PU14AG	.156	1/4	100	Green	42.76
0448230	PU14AY	.156	1/4	100	Yellow	42.76

Thermoplastic Tubing Cont.



Polyurethane Tubing (Fractional) Cont.

Part No.	Vendor No.	ID	OD	Coil Length	Color	Price /Roll
0448310	PU516AC	.187	5/16	100	Clear	\$67.75
0448311	PU516ABK	.187	5/16	100	Black	67.75
0448314	PU516ANB	.187	5/16	100	Navy Blue	67.75
0448313	PU516AR	.187	5/16	100	Red	67.75
0448312	PU516AG	.187	5/16	100	Green	67.75
0448282	PU38AC	.250	3/8	100	Clear	87.35
0448283	PU38ABK	.250	3/8	100	Black	87.35
0448285	PU38ANB	.250	3/8	100	Navy Blue	87.35
0448289	PU38ACB	.250	3/8	100	Translucent Blue	87.35
0448284	PU38AR	.250	3/8	100	Red	87.35
0448288	PU38ACR	.250	3/8	100	Translucent red	87.35
0447815	PU38AG	.250	3/8	100	Green	87.35
0448286	PU38AY	.250	3/8	100	yellow	87.35
0448764	PU38CC	.250	3/8	500	Clear	394.50
0448765	PU38CBK	.250	3/8	500	Black	394.50
0448769	PU38CY	.250	3/8	500	yellow	394.50
0448185	PU12AC	.328	1/2	100	Clear	167.50
0448186	PU12ABK	.328	1/2	100	Black	167.50
0448189	PU12ANB	.328	1/2	100	Navy Blue	167.50
0448188	PU12AR	.328	1/2	100	Red	167.50
0448192	PU12ACR	.328	1/2	100	translucent red	167.50
0448190	PU12AY	.328	1/2	100	yellow	167.50

Polyurethane Tubing (Metric)

- The most flexible thermoplastic tubing available
- Great abrasion and kink resistance
- 98A durometer
- Perfect for push-to-connect fittings
- High degree of dimensional stability
- Ether based material provides excellent resistance to moisture, oil, and cold

Part No.	Vendor No.	OD	ID	Coil Length	Color	Price/Roll
0448510	PU04MEC	4mm	2.5mm	25m	Clear	\$23.38
0448504	PU04MEBK	4mm	2.5mm	25m	Black	23.38
0448505	PU04MEGY	4mm	2.5mm	25m	Grey	23.38
0448507	PU04MENB	4mm	2.5mm	25m	Navy Blue	23.38
0448506	PU04MER	4mm	2.5mm	25m	Red	23.38
0448508	PU04MEY	4mm	2.5mm	25m	Yellow	23.38
0448395	PU04MFBK	4mm	2.5mm	100m	Black	81.85
0448550	PU06MEC	6mm	4mm	25m	Clear	30.73
0448544	PU06MEBK	6mm	4mm	25m	Black	30.73
0448549	PU06MEGY	6mm	4mm	25m	Grey	30.73
0448547	PU06MENB	6mm	4mm	25m	Navy Blue	30.73
0448546	PU06MER	6mm	4mm	25m	Red	30.73
0448545	PU06MEG	6mm	4mm	25m	Green	30.73
0448548	PU06MEY	6mm	4mm	25m	Yellow	30.73
0445820	PU06MFBK	6mm	4mm	100m	Black	107.55
0445823	PU06MFNB	6mm	4mm	100m	Navy Blue	107.56
0448567	PU08MEC	8mm	5mm	25m	Clear	54.65
0448561	PU08MEBK	8mm	5mm	25m	Black	54.65
0448566	PU08MEGY	8mm	5mm	25m	Grey	54.65
0448564	PU08MENB	8mm	5mm	25m	Navy Blue	54.65
0448563	PU08MER	8mm	5mm	25m	Red	54.65
0448562	PU08MEG	8mm	5mm	25m	Green	54.65
0448565	PU08MEY	8mm	5mm	25m	Yellow	54.65
0448412	PU08MFBK	8mm	5mm	100m	Black	191.27
0448415	PU08MFNB	8mm	5mm	100m	Navy Blue	191.27
0448467	PU10MEC	10mm	6.5mm	25m	Clear	75.30
0448462	PU10MEBK	10mm	6.5mm	25m	Black	75.30
0448464	PU10MENB	10mm	6.5mm	25m	Navy Blue	75.30
0448465	PU10MEY	10mm	6.5mm	25m	Yellow	75.30
0448484	PU12MEC	12mm	8mm	25m	Clear	119.85
0448479	PU12MEBK	12mm	8mm	25m	Black	119.85
0448481	PU12MENB	12mm	8mm	25m	Navy Blue	119.85
0445827	PU12MFNB	12mm	8mm	100m	Navy Blue	419.38



Polyurethane, Polyethylene, Nylon, PTFE & FEP Tubing



Armorthane™ Polyurethane Braided Spiral Hose

ATP is your **CHOICE** for Polyurethane, Nylon, Polyethylene, PTFE, FEP and Spatter-Resistant Weld Tubing. We also specialize in Polyurethane Spiral Hose, Braided Hose (Straight and Spiraled), Technibond®, Hose and Cable Balancers and Blow Guns.



Armor-Air™ Polyurethane Braided Straight Hose



Hose & Cable Balancers



Blow Guns



Free Angle® Swivel Fittings

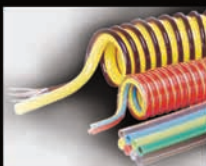

Technibond® Polyurethane Straight & Spiral Tubing

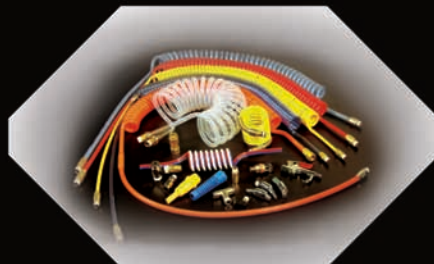

Spiral Hoses with Accessories



Technithane™ Polyurethane Spiral Hose

POLYURETHANE AND PVC TUBING

Thermoplastic Tubing Cont.

FAT-N | Weatherhead

Thermoplastic Tubing

PT240 Polyethylene

- **Typical Application:** Economical, flexible, low density polyethylene has a wide range of uses in industrial and agricultural applications.
- **Temperature Range:** -40°F to +135°F (-40°C to +57°C)
- **Available Colors:** Natural off-white, black, yellow, orange, blue, red, and green. FDA colors available on request. Refer to current price list for availability of colors.
- **Contains:** Ultra-Violet stabilizer in black tubing.
- **Note:** * IS BULK.

COLOR GUIDE: NA = Natural, BK = Black, YW = Yellow, OR = Orange, BU = Blue, RD = Red, GN=Green, GY = Gray

Specifications

Part No.	Tube O.D.	Tube Wall	Max. Work Pressure PSI 70°F	Min. Burst Pressure PSI 70°F	Min. Bend Radius 70°F	Lbs./100 ft.	Coil Lgth.
PT24004	1/4 (.250)	.062	200	600	.75"	1.5	100,*1000
PT24044	1/4 (.250)	.040	133	400	.62"	1.0	100,*1000
PT24005	5/16 (.312)	.062	135	480	1.0"	1.9	100,*1000
PT24006	3/8 (.375)	.062	135	400	1.5"	2.4	100,*1000
PT24008	1/2 (.500)	.062	100	300	2.0"	3.4	100,500
PT24010	5/8 (.625)	.062	80	240	2.5"	4.4	100
PT24012	3/4 (.750)	.094	70	210	3.0"	7.6	100
PT24016	1 (1.000)	.125	100	300	5.0"	13.4	100

Natural compound covered under FDA 21CFR177.1520 regulations for food contact.

Tube O.D. - 1/4 (.062 Wall)

Part No.	Color	Vendor No.	Coil Lgth.	Price /Roll
450000-131280	NA	PT24004	100	\$42.25
0450071	BK	PT24004	100	42.25
0450072	YW	PT24004	100	42.25
0450073	OR	PT24004	100	42.25
0450074	BU	PT24004	100	42.25
0450075	RD	PT24004	100	42.25
0450076	GN	PT24004	100	42.25
450001-131280	NA	PT24004	*1000	184.50
0450078	BK	PT24004	*1000	184.50
0450079	YW	PT24004	*1000	184.50
0450080	OR	PT24004	*1000	184.50
0450081	BU	PT24004	*1000	184.50
0450082	RD	PT24004	*1000	184.50
0450083	GN	PT24004	*1000	184.50

Tube O.D. - 1/4 (.040 Wall)

Part No.	Color	Vendor No.	Coil Lgth.	Price /Roll
450002-131280	NA	PT24044	100	\$41.50
0450085	BK	PT24044	100	41.50
0450086	YW	PT24044	100	41.50
0450087	OR	PT24044	100	41.50
0450088	BU	PT24044	100	41.50
0450090	GN	PT24044	100	41.50
450003-131280	NA	PT24044	*1000	175.20
0450092	BK	PT24044	*1000	175.20
0450095	BU	PT24044	*1000	175.20

Tube O.D. - 5/16 (.062 Wall)

Part No.	Color	Vendor No.	Coil Lgth.	Price /Roll
450004-131280	NA	PT24005	100	\$47.35
0450100	YW	PT24005	100	47.35
0450102	BU	PT24005	100	47.35
450005-131280	NA	PT24005	*1000	195.50
0450106	BK	PT24005	*1000	195.50
0450111	GN	PT24005	*1000	195.50

Tube O.D. - 3/8 (.062 Wall)

Part No.	Color	Vendor No.	Coil Lgth.	Price /Roll
450006-131280	NA	PT24006	100	\$49.50
0450113	BK	PT24006	100	49.50
0450114	YW	PT24006	100	49.50
0450115	OR	PT24006	100	49.50
0450116	BU	PT24006	100	49.50

Part No.	Color	Vendor No.	Coil Lgth.	Price /Roll
0450117	RD	PT24006	100	\$49.50
0450118	GN	PT24006	100	49.50
450007-131280	NA	PT24006	*1000	245.80
0450120	BK	PT24006	*1000	245.80
0450121	YW	PT24006	*1000	245.80
0450122	OR	PT24006	*1000	245.80
0450123	BU	PT24006	*1000	245.80
0450124	RD	PT24006	*1000	245.80
0450125	GN	PT24006	*1000	245.80

Tube O.D. - 1/2 (.062 Wall)

Part No.	Color	Vendor No.	Coil Lgth.	Price /Roll
450008-131280	NA	PT24008	100	\$62.50
0450129	OR	PT24008	100	62.50
0450130	BU	PT24008	100	62.50
0450131	RD	PT24008	100	62.50
450009-131280	NA	PT24008	*500	177.50
0450134	BK	PT24008	*500	177.50
0450136	OR	PT24008	*500	177.50
0450137	BU	PT24008	*500	177.50
0450138	RD	PT24008	*500	177.50

Tube O.D. - 5/8 (.062 Wall)

Part No.	Color	Vendor No.	Coil Lgth.	Price /Roll
450010-131280	NA	PT24010	100	\$66.25

Tube O.D. - 3/4 (.04 Wall)

Part No.	Color	Vendor No.	Coil Lgth.	Price /Roll
450011-131280	NA	PT24012	100	\$82.50

Tube O.D. - 1 (.125 Wall)

Part No.	Color	Vendor No.	Coil Lgth.	Price /Roll
450012-131280	NA	PT24016	100	\$283.00

PT200 Polyvinyl Chloride "PVC"

- **Typical Application:** Soft pliable, plasticized PVC Resin Tubing, for practically any low pressure laboratory, industrial, agricultural or domestic application.
- **Temperature Range:** -5°F to +105°F (-20°C to +41°C)
- **Available Colors:** Clear (NA)

Specifications

Part No.	Tube O.D.	Tube Wall	Max. Work Pressure PSI 70°F	Min. Burst Pressure PSI 70°F	Min. Bend Radius 70°F	Lbs./100 ft.	Coil Lgth.
PT20004	1/4 (.250)	.062	65	195	1.0"	2.0	100
PT20044	1/4 (.250)	.040	55	165	1.0"	2.0	100
PT20005	5/16 (.312)	.062	55	165	1.25"	2.6	100
PT20006	3/8 (.375)	.062	55	165	1.5"	3.3	100
PT20008	1/2 (.500)	.062	45	135	2.0"	4.6	100
PT20010	5/8 (.625)	.062	30	90	2.5"	5.9	100
PT20012	3/4 (.750)	.094	40	120	3.0"	10.3	100
PT20016	1 (1.000)	.125	.35	105	4.0"	18.5	100

Part No.	Color	Vendor No.	Tube OD	Coil Lgth.	Price /Roll
450032-131280	Clear	PT20004	1/4	100	\$23.28
450033-131280	Clear	PT20044	1/4	100	84.50
450034-131280	Clear	PT20005	5/16	100	38.26
450035-131280	Clear	PT20006	3/8	100	44.83
450036-131280	Clear	PT20008	1/2	100	60.85
450037-131280	Clear	PT20010	5/8	100	76.90
450038-131280	Clear	PT20012	3/4	100	124.00
450039-131280	Clear	PT20016	1	100	217.00

NYLON 6/6 AND NYLON II TUBING

Tubing

Thermoplastic Tubing Cont.

EATON | Weatherhead

PT230 Polyamide "Nylon 6/6"

- **Typical Application:** Semi-rigid general purpose tubing.
- **Temperature Range:** -40°F to +180°F (-40°C to +82°C)
- **Available Colors:** Natural and black. FDA colors available on request.
- **Contains:** Ultra-Violet stabilizer in black tubing.
- **Note:** * IS BULK.

COLOR GUIDE: NA = Natural, BK = Black, YW = Yellow, OR = Orange, BU = Blue, RD = Red, GN=Green, GY = Gray

Specifications

Part No.	Tube O.D.	Tube Wall	Max. Work Pressure PSI 70°F	Min. Burst Pressure PSI 70°F	Min. Bend Radius 70°F	Lbs./100 ft.	Coil Lgth.
PT23002	1/8 (.125)	.015	300	1000	.75"	.3	100,*1000
PT23003	3/16 (.188)	.023	300	1000	1.25"	.6	100,*1000
PT23004	1/4 (.250)	.030	300	1000	1.5"	1.0	100,*1000
PT23005	5/16 (.312)	.036	300	1000	2.0"	1.5-1.6	100,*1000
PT23006	3/8 (.375)	.040	300	1000	2.25"	2.1	100,*1000
PT23008	1/2 (.500)	.062	300	1000	3.0"	4.2-4.3	100,*500

Natural compound covered under FDA 21CFR177.1500 regulations for food contact.

Part No.	Color	Vendor No.	Tube O.D.	Coil Lgth.	Price /Roll
450040-131280	NA	PT23002	1/8	100	\$21.50
0450581	BK	PT2300	1/8	100	21.50
450041-131280	NA	PT23002	1/8	*1000	145.30
450042-131280	NA	PT23003	3/16	100	35.50
0450583	BK	PT23003	3/16	100	35.50
450043-131280	NA	PT23003	3/16	*1000	285.00
0450584	BK	PT23003	3/16	*1000	285.00
450044-131280	NA	PT23004	1/4	100	47.50
0450585	BK	PT23004	1/4	100	47.50
450045-131280	NA	PT23004	1/4	*1000	295.50
0450586	BK	PT23004	1/4	*1000	295.50
450046-131280	NA	PT23005	5/16	100	59.75
0450587	BK	PT23005	5/16	100	59.75
0450588	BK	PT23005	5/16	*1000	372.50
450048-131280	NA	PT23006	3/8	100	87.45
0450589	BK	PT23006	3/8	100	87.45
450049-131280	NA	PT23006	3/8	*1000	535.30
450050-131280	NA	PT23008	1/2	100	125.00
0450591	BK	PT23008	1/2	100	125.00
450051-131280	NA	PT23008	1/2	500	425.00
0450592	BK	PT23008	1/2	*500	425.00

TP160 Polyamide "Nylon 11"

- **Typical Application:** Flexible nylon tubing. Used for instrumentation; lubrication and air lines; gas, chemical and oil processing; low pressure hydraulics.
- **Temperature Range:** -40°F to +200°F (-40°C to +93°C)
- **Available Colors:** Black or natural
- **Contains:** Ultra-Violet stabilizer in black tubing.
- **Note:** * IS BULK.

COLOR GUIDE: NA = Natural, BK = Black, YW = Yellow, OR = Orange, BU = Blue, RD = Red, GN=Green, GY = Gray

Part No.	Color	Vendor No.	Tube O.D.	Coil Lgth.	Price /Roll
TP16002	1/8 (.125)	.023	250	1000	5/8" 0.3 100,*1000
TP16025	5/32 (.156)	.029	250	1000	1" .75 100,*1000
TP16004	1/4 (.250)	.040	250	1000	1-1/4" 1.2 100,*1000
TP16005	5/16 (.312)	.040	250	1000	2" 2.0 100,*1000
TP16006	3/8 (.375)	.062	250	1000	3.0" 2.7 100,*1000
TP16008	1/2 (.500)	.062	250	1000	4.5" 3.8 100,*500

Part No.	Color	Vendor No.	Tube O.D.	Coil Lgth.	Price /Roll
450052-131280	NA	TP16002	1/8	100	\$25.20
0450593	BK	TP16002	1/8	100	25.20
450053-131280	NA	TP16002	1/8	*1000	210.00
0450594	BK	TP16002	1/8	*1000	210.00
450054-131280	NA	TP16025	5/32	100	26.50
0450595	BK	TP16025	5/32	100	26.50
450055-131280	NA	TP16025	5/32	*1000	238.50
0450596	BK	TP16025	5/32	*1000	238.50
450056-131280	NA	TP16004	1/4	100	53.40
0450597	BK	TP16004	1/4	100	53.40
450057-131280	NA	TP16004	1/4	*1000	496.50
0450598	BK	TP16004	1/4	*1000	496.50
450058-131280	NA	TP16005	5/16	100	73.20
0450599	BK	TP16005	5/16	100	73.20
450059-131280	NA	TP16005	5/16	*1000	655.00
0450600	BK	TP16005	5/16	*1000	655.00
450060-131280	NA	TP16006	3/8	100	110.00
0450601	BK	TP16006	3/8	100	110.00
450061-131280	NA	TP16006	3/8	*1000	995.90
0450602	BK	TP16006	3/8	*1000	995.90
450062-131280	NA	TP16008	1/2	100	162.00
0450603	BK	TP16008	1/2	100	162.00
450063-131280	NA	TP16008	1/2	500	790.00
0450604	BK	TP16008	1/2	500	790.00

MTP160 Polyamide "Nylon 11" Metric Tubing

- **Typical Application:** Flexible nylon tubing. Used for instrumentation; lubrication and air lines; gas, chemical and oil processing; low pressure hydraulics.
- **Temperature Range:** -40°F to +200°F (-40°C to +93°C)
- **Contains:** Ultra-violet stabilizer.
- **Available Colors:** Natural

Specifications

Part No.	Tube O.D.	Tube Wall	Max. Work Pressure PSI 70°F	Min. Burst Pressure PSI 70°F	Min. Bend Radius 70°F	Lbs./100 ft.	Coil Lgth.
MTP16004	4	.65	250	1000	3/4	0.6	100
MTP16005	5	1	250	1000	1	0.9	100
MTP16006	6	1	250	1000	1-1/2	1.1	100
MTP16008	8	1	250	1000	2-1/4	1.5	100
MTP16010	10	1	200	800	3	1.9	100
MTP16012	12	1	112	450	3-1/2	2.3	100

Part No.	Vendor No.	Tube O.D.	Coil Lgth.	Price /Roll
450064-131280	MTP16004	4mm	100	\$32.20
450065-131280	MTP16005	5mm	100	71.50
450066-131280	MTP16006	6mm	100	84.80
450067-131280	MTP16008	8mm	100	109.00
450068-131280	MTP16010	10mm	100	132.00
450069-131280	MTP16012	12mm	100	164.00

THERMOPLASTIC TUBING & TUBE CUTTING TOOLS

Thermoplastic Tubing Cont.



Tubing

Nylon 12 Tubing (Fractional and Metric)

- Considered as the industry standard for applications requiring higher working pressures
- Higher heat and better chemical resistance than polyurethane
- Longer service life
- For use with push-to-connect, compression, or barbed fittings



Part No.	Vendor No.	OD	ID	Coil Length	Color	Price /Roll
Fractional						
0448269	N18ANA	1/8	.062	100	Natural	\$14.53
0448270	N18ABK	1/8	.062	100	Black	14.53
0448273	N18AB	1/8	.062	100	Blue	14.53
0448355	N532ANA	5/32	.106	100	Natural	16.82
0448356	N532ABK	5/32	.106	100	Black	16.82
0448359	N532AB	5/32	.106	100	Blue	16.82
0448358	N532AR	5/32	.106	100	Red	16.82
0448362	N532AOR	5/32	.106	100	Orange	16.82
0448357	N532AG	5/32	.106	100	Green	16.82
0448361	N532AY	5/32	.106	100	Yellow	16.82
0448839	N532CBK	5/32	.106	500	Black	86.35
0448842	N532CB	5/32	.106	500	Blue	86.35
0448840	N532CG	5/32	.106	500	Green	86.35
0448443	N532DB	5/32	.106	1000	Blue	154.06
0448234	N14ANA	1/4	.180	100	Natural	31.79
0448235	N14ABK	1/4	.180	100	Black	31.79
0448238	N14AB	1/4	.180	100	Blue	31.79
0448237	N14AR	1/4	.180	100	Red	31.79
0448241	N14AOR	1/4	.180	100	Orange	31.79
0448236	N14AG	1/4	.180	100	Green	31.79
0448239	N14AY	1/4	.180	100	Yellow	31.79
0448714	N14CNA	1/4	.180	500	Natural	152.70
0448715	N14CBK	1/4	.180	500	Black	152.70
0448718	N14CB	1/4	.180	500	Blue	152.70
0448420	N14DNA	1/4	.180	1000	Natural	305.40
0448421	N14DBK	1/4	.180	1000	Black	305.40
0448297	N38ANA	3/8	.275	100	Natural	67.56
0448298	N38ABK	3/8	.275	100	Black	67.56
0448301	N38AB	3/8	.275	100	Blue	67.56
0448300	N38AR	3/8	.275	100	Red	67.56
0448302	N38AY	3/8	.275	100	Yellow	67.56
0448779	N38CNA	3/8	.275	500	Natural	331.98
0448780	N38CBK	3/8	.275	500	Black	331.98
0448201	N12ANA	1/2	.375	100	Natural	111.61
0448202	N12ABK	1/2	.375	100	Black	111.61
0448205	N12AB	1/2	.375	100	Blue	111.61
0448322	N12AR	1/2	.375	100	Red	53.13
0448681	N12CNA	1/2	.375	500	Natural	508.49
0448682	N12CBK	1/2	.375	500	Black	508.49

Nylon 12 Tubing (Fractional and Metric) Cont.

Part No.	Vendor No.	OD	ID	Coil Length	Color	Price /Roll
Metric						
0448527	N04MENA	4mm	2.3mm	25m	Natural	\$25.90
0448528	N04MEBK	4mm	2.3mm	25m	Black	28.85
0448531	N04MEB	4mm	2.3mm	25m	Blue	28.85
0448523	N04MER	4mm	2.3mm	25m	Red	20.31
0448525	N04MEY	4mm	2.3mm	25m	Yellow	20.31
0448538	N06MENA	6mm	4mm	25m	Natural	43.05
0448554	N06MEBK	6mm	4mm	25m	Black	43.05
0448555	N06MEGY	6mm	4mm	25m	Grey	43.05
0448557	N06MEB	6mm	4mm	25m	Blue	43.05
0448556	N06MER	6mm	4mm	25m	Red	43.05
0448558	N06MEY	6mm	4mm	25m	Yellow	43.05
0445798	N06MFBK	6mm	4mm	100m	Black	167.37
0445801	N06MFB	6mm	4mm	100m	Blue	167.37
0448577	N08MENA	8mm	6mm	25m	Natural	56.91
0448578	N08MEBK	8mm	6mm	25m	Black	56.91
0448579	N08MEGY	8mm	6mm	25m	Grey	56.91
0448581	N08MEB	8mm	6mm	25m	Blue	56.91
0448580	N08MER	8mm	6mm	25m	Red	56.91
0445803	N08MFNA	8mm	6mm	100m	Natural	199.25
0445807	N08MFB	8mm	6mm	100m	Blue	199.25
0448468	N10MENA	10mm	8mm	25m	Natural	76.76
0448469	N10MEBK	10mm	8mm	25m	Black	76.76
0448472	N10MEB	10mm	8mm	25m	Blue	76.76
0448475	N12MENA	12mm	10mm	25m	Natural	89.61
0448476	N12MEBK	12mm	10mm	25m	Black	89.61
0448477	N12MEB	12mm	10mm	25m	Blue	89.61
0448491	N14MENA	14mm	12mm	25m	Natural	115.25
0448495	N14MEBK	14mm	12mm	25m	Black	115.25
0448496	N14MENB	14mm	12mm	25m	Blue	115.25

Tube Cutting Tools

EAT-N | Weatherhead

Plastic Tube and Hose Cutter

This versatile tool is light weight and durable for long service life. 1" capacity.

NOTE: Not for use with wire reinforced hose.



Part No.	Price /Each
0450605	\$41.98

legris
connectic

A tool designed to be small, only 2-7/8" long. Offers quick and clean square cuts on 1/16" to 1/2" O.D. plastic tubing and non-wire reinforced hose.



Part No.	Price /Each
0450606	\$12.18

COALESCING FILTERS AND FILTER ELEMENTS

Air Treatment

Finite®

Coalescing Filters Aluminum Construction

Finite's coalescing filters are designed with our specialized UNI-CAST glass microfibers, providing you with lower pressure drop and longer filter life. *A = Automatic float drain included, D = Differential Pressure Gauge included, I = Differential Pressure Indicator included.



Air Preparation

Part No.	Vendor No.	Weight	Description	Length	Flow Rate	Port Size	Maximum Temperature	Maximum Pressure (PSI)	Micron	Efficiency (%)	Price /Ea
0422257	HN2S-6CW	1.44	Accessories Included: A, I	9.4 "	25 SCFM	1/2"	175 F	250 PSIG	0.01 um	99.97	\$192.05
0422258	HN2L-6CW	1.85	Accessories Included: A, I	9.4 "	50 SCFM	1/2"	175 F	250 PSIG	0.01 um	99.97	217.29
0422259	HN5S-6CUY	12.11	Accessories Included: A, D	21.66 "	250 SCFM	1 1/4"	175 F	250 PSIG	0.01 um	99.97	691.87
0422260	HN6S-6CUY	11.97	Accessories Included: A, D	21.66 "	350 SCFM	1 1/2"	175 F	250 PSIG	0.01 um	99.97	816.69
0422261	HN8S-6CUY	14	Accessories Included: A, D	27.66 "	450 SCFM	2"	175 F	250 PSIG	0.01 um	99.97	1164.21
0422262	HN8L-6CUY	15.99	Accessories Included: A, D	32.66 "	625 SCFM	2"	175 F	250 PSIG	0.01 um	99.97	1280.65
0422263	HN0L-6CUY	35	Accessories Included: A, D	39.13 "	800 SCFM	2 1/2"	175 F	250 PSIG	0.01 um	99.97	1485.97
0422264	HN12L-6CUY	34.14	Accessories Included: A, D	39.13 "	1000 SCFM	3"	175 F	250 PSIG	0.01 um	99.97	1808.89

Water Separator Filters Aluminum Construction

Finite's liquid separators are ideal for removing bulk amounts of liquid from a compressed air or gas stream. *A = Automatic float drain included.



Part No.	Vendor No.	Weight	Description	Height	Flow Rate	Port Size	Maximum Temperature	Maximum Pressure (PSI)	Micron	Price /Ea
0422255	HN2S-100WSUA	1.44	Accessories Included: A	7.59"	83 SCFM	1/2"	175 F	250 PSIG	100 um	\$184.20
0422256	HN4S-100WSUA	3.29	Accessories Included: A	11.65"	232 SCFM	1"	175 F	250 PSIG	100 um	510.41

Coalescing Filters and Water Separator Filters Aluminum Head with Clear Bowl



Part No.	Vendor No.	Description	Weight	Width	Length	Flow Rate	Port Size	Maximum Temperature	Maximum Pressure (PSI)	Micron	Efficiency (%)	Price /Ea
0422265	QN1N-100WSUN	Removes Water	0.86	3.12"	5.5 "	50 SCFM	1/4"	125 F	125 PSIG	100 um	-	\$123.54
0422266	QN1N-6CN	Removes Oil	0.86	3.12"	5.5 "	15 SCFM	1/4"	125 F	125 PSIG	.01 um	99.97	90.03

Replacement Coalescing Filter Elements



Part No.	Vendor No.	Description	Weight	Price /Ea
0422267	6C10-025 X 8	Replacement Filter fits Fastenal Part Numbers: 0422257 and 0422266	0.06	\$18.26
0422268	6C10-050 X 4	Replacement Filter fits Fastenal Part Number: 0422258	0.13	31.73

Replacement Water Separator Filter Elements



Part No.	Vendor No.	Description	Weight	Price /Ea
0422269	100WSU10-025 X 1	Replacement filter element fits Fastenal Part Numbers: 0422255 and 0422265	0.5	\$56.10
0422270	100WSU15-060 X 1	Replacement filter element fits Fastenal Part Number: 0422256	1	116.33

DESSICANT FILTERS & FILTER ACCESSORIES

Air Treatment Cont.

Air Preparation

Finite®

Desiccant Dryer Housing

Finite's desiccant dryers remove water vapor from compressed air and protect critical point-of-use equipment



Part No.	Vendor No.	Weight	Length	Width	Flow Rate	Maximum Pressure Rating	Connector Size	Price /Ea
0422276	FDD15-02	8	13-1/2"	4-15/16"	15 SCFM	300 PSIG	1/4"	\$249.42
0422277	FDD30-04	13	23-1/4"	4-15/16"	30 SCFM	300 PSIG	1/2"	400.33
0422278	FDD60-08	20	30-1/4"	4-15/16"	60 SCFM	300 PSIG	1"	597.80

Silica Gel Dessiccant for FDD Dryers

Replaceable silica gel desiccant is used to remove water vapor from compressed air.



Part No.	Vendor No.	Description	Weight (lbs.)	Price /Ea
0422279	FSGM100-1	Silica Gel Desiccant, 5lb Can	5	\$97.45
0422280	FSGM100-4	Silica Gel Desiccant, 4 x 5lb Cans	20	332.80

Inline Indicator for Water and Oil

Oil/Water indicator provides peace-of-mind for critical applications by indicating the presence of liquid oil or water in a compressed air system.



Part No.	Vendor No.	Description	Weight	Port Size	Maximum Temperature	Maximum Pressure (PSI)	Price /Ea
0422281	KSDS-W	Water Indicator	.05 lbs.	1/8"	125 F	100 PSIG	\$43.84
0422282	KSDS-O	Oil Indicator	.05 lbs.	1/8"	125 F	100 PSIG	43.84

Disposable Inline Filter

Finite's high efficiency, disposable inline filters are great for instrument air panels, analyzer and sensor protection, gas sampling, micro-system operation, robot and automation air preparation.



Part No.	Vendor No.	Weight	Width	Length	Flow Rate	Port Size	Maximum Temperature	Maximum Pressure (PSI)	Price /Ea
0422283	IDN-6G X 10	0.1	1"	3.3"	3.5 SCFM	1/4" OD	125 F	100 PSIG	\$9.77

Electrically Timed Solenoid Drain Valve

Finite's timed solenoid drain valves can be set to automatically remove condensate at varying frequencies throughout the day.



Part No.	Vendor No.	Description	Price /Ea
0422271	TV-25	1/4" NPT, 300 PSIG Max.	\$129.04
0422272	TV-50	1/2" NPT, 300 PSIG Max.	129.04

Drip Leg Drain

Finite's drip leg kits are ideal for removing free water at air drops throughout a manufacturing facility.



Part No.	Vendor No.	Description	Port Size	Price /Ea
0422274	DL2-VS50	Visual sump and automatic float drain	1/2"	\$317.64

Zero Air Loss Drain Valve

Finite's zero loss drains will automatically remove condensate without the loss of valuable compressed air.



Part No.	Vendor No.	Port Size	Maximum Pressure (PSI)	Price /Ea
0422273	ZLD-013	1/2"	232 PSIG	\$259.18

FILTERS, REGULATORS & LUBRICATORS

Air Treatment Cont.



Filters

Standard Filters

Designed to remove rust, scale, condensed water, and other debris from compressed air lines which may cause wear and premature failure of tools, valves, cylinders, and other pneumatic equipment.

Bowl guard has full length slots for easy visual checking of fluids.

Note: Port size in NPT.



Air Preparation

Port Size	Filter	Max. Flow CFM	Bowl Type	Bowl Size	Max. Temp.	Max. Inlet Pressure	Part No.	Vendor No.	Ship Wt. (lbs)	Price /Each
1/4"	40m	54	Poly with Guard	6 oz.	125	150	0470040	F25221-100	1.48	\$33.32
1/2"	40m	122	Poly with Guard	6 oz.	125	150	0470042	F25241-100	1.43	33.32
3/4"	40m	120	Poly with Guard	10 oz.	125	200	0470043	25351-020	3.48	93.27
1"	40m	120	Poly with Guard	10 oz.	125	200	0470044	25361-020	3.26	93.27

Regulators

Provides controlled, consistent air pressure as required for specific pneumatic equipment connected to the compressed air system. Relieving models vent downstream overpressure. Supplied with gauge.

Can be mounted up, down or panel/wall mounted.

Note: Port size and gauge port in NPT.



Port Size	Pressure Range	Max. Flow CFM	Gauge Port	Max. Inlet Pressure	Part No.	Vendor No.	Ship Wt. (lbs)	Price /Each
1/8"	5-125	13	1/8"	200	0470052	R27111-600	1.38	\$23.78
1/4"	5-125	13	1/8"	200	0470053	R27121-600	1.34	23.78
1/4"	5-125	100	1/4"	200	0470054	R27221-600	1.38	46.46
3/8"	5-125	130	1/4"	200	0470055	R27231-600	1.34	46.46
1/2"	5-125	150	1/4"	200	0470056	R27241-600	1.3	46.46
3/4"	5-125	287	1/4"	250	0470057	27354-600	3.21	106.20

Should be installed close to the downstream application to ensure effective distribution of oil to the pneumatic components.

Bowl guard has full length slots for easy visual checking of lubricant.

Note: Port size in NPT.



Air Lubricators

Port Size	Flow Rate	Bowl Type	Bowl Size	Max. Temp.	Max. Inlet Pressure	Part No.	Vendor No.	Ship Wt. (lbs)	Price /Each
3/8"	100	Poly with Guard	6 oz.	125	150	0470069	L26231-100	1.44	\$48.04
1/2"	110	Poly with Guard	6 oz.	125	150	0470070	L26241-100	1.36	48.04
3/4"	100	Poly with Guard	10 oz.	125	200	0470071	26351-020	2.98	120.21

Filter/Regulator (1 Piece)

Combined air filtration and regulation in a single, compact unit. Saves space for added system design flexibility.

Piggyback filter regulators supplied with pressure gauge.

Bowl guard has full length slots for easy visual checking of lubricant.

Note: Port size and gauge port in NPT.



Port Size	Pressure Range	Filter	Gauge Port	Max. Flow CFM	Bowl Type	Bowl Size	Max. Inlet Pressure	Part No.	Vendor No.	Ship Wt. (lbs)	Price /Each
1/4"	5-125	20m	1/8"	13	Poly with Guard	1 oz.	125	0470060	P29122-600	0.29	\$36.90
1/4"	5-125	40m	1/4"	93	Poly with Guard	6 oz.	125	0470061	P29221-600	2.05	63.77
3/8"	5-125	40m	1/4"	135	Poly with Guard	6 oz.	125	0470062	P29231-600	2.03	63.77
1/2"	5-125	40m	1/4"	140	Poly with Guard	6 oz.	125	0470063	P29241-600	2.00	63.77
3/4"	5-125	40m	1/4"	140	Poly with Guard	8 oz.	125	0470064	P29351-600	6.00	142.45

The : symbol after a price denotes that it is a Direct Ship Product (DSP) and shipping, availability & lead times may vary.

FILTERS, REGULATORS & LUBRICATORS

Air Treatment Cont.



Air Preparation

Filter/Regulator/Lubricator 2 Piece Combination Filter-Regulator-Lubricator and gauge



Port Size	Max. Flow CFM	Bowl Size	Max. Inlet Pressure	Part No.	Vendor No.	Ship Wt. (lbs)	Price /Each
1/4"	15	1 oz.	150	0470081	C28121-600	4.06	\$57.95
1/2"	150	6 oz.	150	0470084	C28241-600	3.9	129.78
1"	150	8 oz.	200	0470086	C28361-600	5.8	186.43

Filter/Regulator/Lubricator 3 Piece Combination Filter- Regulator-Lubricator and gauge



Port Size	Max. Flow CFM	Bowl Size	Max. Inlet Pressure	Part No.	Vendor No.	Ship Wt. (lbs)	Price /Each
3/8"	130	6 oz.	150	0470076	C28231-800	5.4	\$157.49
1/2"	150	6 oz.	150	0470077	C28241-800	5.3	157.49

Regulator Mounting Brackets

- Easy to install wall mount bracket



Usage	Part No.	Vendor No.	Price /Each
Mid-Size 1/4" -3/8" -1/2" NPT	0470095	104172	\$6.75



5 Micron Modular Air Filter

- 5 micron filtration
- Bracket and bowl guard included



Part No.	Vendor No.	Description	Port Size	Price /Ea
0421950	AF10-M5-Z	Rotary type Drain cock	M5X0.8	\$13.97
0421951	AF20-N01B-CZ	Float type auto-drain	1/8" NPT	28.22
0421952	AF20-N02B-CZ	Float type auto-drain	1/4" NPT	28.22
0421953	AF30-N03B-Z	Rotary type Drain cock	3/8" NPT	34.32
0421954	AF40-N04B-Z	Rotary type Drain cock	1/2"PT	46.26
0421955	AF50-N06B-Z	Rotary type Drain cock	3/4" NPT	75.90
0421956	AF60-N10B-Z	Rotary type Drain cock	1" NPT	95.15

Modular Air Regulator

- High relief sensitivity, comes with gage and mounting bracket
- 0-160 PSI

In the Vendor Number, BG = Round Pressure Gauge and BE = Square Embedded Pressure Gauge.



Part No.	Vendor No.	Port Size	Price /Ea
0421957	AR10-M5BG-Z	M5	\$27.39
0421958	AR20-N01BG-Z	1/8" NPT	28.77
0421959	AR20-N02BG-Z	1/4" NPT	28.77
0421960	AR30-N03BG-Z	3/8" NPT	38.45
0421961	AR40-N04BG-Z	1/2" NPT	46.64
0421962	AR50-N06BG-Z	3/4" NPT	73.48
0421963	AR60-N10BG-Z	1" NPT	122.49
0421964	AR20-N01BE-Z	1/8" NPT	28.77
0421965	AR20-N02BE-Z	1/4" NPT	28.77
0421966	AR30-N03BE-Z	3/8" NPT	38.45
0421967	AR40-N04BE-Z	1/2" NPT	46.64

Modular Air Lubricator

- Large bowl capacities
- Lubrication volume adjustment setting
- Mounting Bracket



Part No.	Vendor No.	Description	Port Size	Price /Ea
0421968	AL10-M5-3Z	Lubricator with Bracket and Drain Cock	M5X0.8	\$15.73
0421969	AL20-N01B-3CZ	Lubricator with Bracket, Bowl Guard, Drain Cock	1/8" NPT	33.25
0421970	AL20-N02B-3CZ	Lubricator with Bracket and Drain Cock	1/4" NPT	33.25
0421971	AL30-N03B-3Z	Lubricator with Bracket and Drain Cock	3/8" NPT	39.22
0421972	AL40-N04B-3Z	Lubricator with Bracket and Drain Cock	1/2" NPT	47.47
0421973	AL50-N06B-3Z	Lubricator with Bracket and Drain Cock	3/4" NPT	73.43
0421974	AL60-N10B-3Z	Lubricator with Bracket and Drain Cock	1" NPT	95.15

Modular Combo Filter/Regulator

- Compact space saving design
- Comes with Bracket and Gage
- Modular Design

In the Vendor Number, BG = Round Pressure Gauge and BE = Square Embedded Pressure Gauge.



Part No.	Vendor No.	Port Size	Price /Ea
0421975	AW10-M5BG-Z	M5X0.8	\$39.77
0421976	AW20-N01BG-CZ	1/8" NPT	46.92
0421977	AW20-N02BG-CZ	1/4" NPT	46.92
0421978	AW30-N03BG-Z	3/8" NPT	57.75
0421979	AW40-N04BG-Z	1/2" NPT	79.97
0421980	AW40-N06BG-Z	3/4" NPT	99.99
0421981	AW60-N10BG-Z	1" NPT	144.32
0421982	AW20-N01BE-CZ	1/8" NPT	46.95
0421983	AW20-N02BE-CZ	1/4" NPT	46.95
0421984	AW30-N03BE-Z	3/8" NPT	57.75
0421985	AW40-N04BE-Z	1/2" NPT	79.97

AIR TREATMENT & FLOW CONTROLS

Air Treatment Cont.



Modular Combo Filter/Regulator/Lubricator

- Space-saving design
- Comes with Gauge
- Easy Assembly and Mounting



Part No.	Vendor No.	Port Size	Price /Ea
Filter/Regulator/Lubricator Combination			
0421991	AC10-M5G-3Z	M5x0.8	\$67.93
0421992	AC20-N01G-3CZ	1/8" NPT	90.75
0421993	AC20-N02G-3CZ	1/4" NPT	90.75
0421994	AC30-N03G-3Z	3/8" NPT	115.45
0421995	AC40-N04G-3Z	1/2" NPT	146.58
0421996	AC50-N06G-3Z	3/4" NPT	226.44
Filter/Regulator Combination with Piggyback style Filter Regulator			
0421997	AC60-N10G-3Z	1" NPT	316.42
0421998	AC10A-M5G-3Z	M5x0.8	58.74
0421999	AC20A-N01G-3CZ	1/8" NPT	78.16
0422000	AC20A-N02G-3CZ	1/4" NPT	78.16
0422001	AC30A-N03G-3Z	3/8" NPT	96.53
0422002	AC40A-N04G-3Z	1/2" NPT	128.37

Modular Connector Spacer

Easy and quick assembly.



Part No.	Vendor No.	Use With	Price /Ea
0422009	Y100	AC10	\$5.14
0422010	Y200	AC 20	4.84
0422011	Y300	AC30	6.11
0422012	Y400	AC60	6.99
0422013	Y500	AC40 (3/4")	7.81
0422014	Y600	AC50 & AC60	8.69
0422015	Y100T	AC10 with T-Type Mounting Bracket	6.11
0422016	Y200T	AC20 with T-Type Mounting Bracket	7.04
0422017	Y300T	AC30 with T-Type Mounting Bracket	7.81
0422018	Y400T	AC40 with T-Type Mounting Bracket	8.69
0422019	Y500T	AC40 with T-Type Mounting Bracket	9.57
0422020	Y600T	AC50 with BracT-Type Mounting Bracket	11.99

Modular Mist Separator

- .3 Micron Filtration
- Mounting bracket and blow guard provided



Part No.	Vendor No.	Description	Port Size	Price /Ea
0421986	AFM20-N01B-CZ	Float Type Auto-Drain	1/8" NPT	\$54.78
0421987	AFM20-N02B-CZ	Float Type Auto-Drain	1/4" NPT	54.78
0421988	AFM30-N03B-Z	Rotary Type Drain Cock	3/8" NPT	57.86
0421989	AFM40-N04B-Z	Rotary Type Drain Cock	1/2" NPT	67.27
0421990	AFM40-N06B-Z	Rotary Type Drain Cock	3/4" NPT	76.51

Water Separators AMG Series

- Comes with Bracket
- Removes 99% of all liquid present in line



Part No.	Vendor No.	Size	Price /Ea
0422021	AMG150-N02BC	1/4"	\$99.36
0422022	AMG250-N03BC	3/8"	144.66
0422023	AMG350-N04BC	1/2"	204.18
0422024	AMG450-N06BC	3/4"	292.92
0422025	AMG550-N10BC	1"	380.40
0422026	AMG650-N14BD	1-1/2"	510.42
0422027	AMG850-N20BD	2"	1338.93

Replacement Filter Elements for AMG Separators

- Long life, easy replacement



part No.	Vendor No.	Description	Price /Ea
0422028	AMG-EL150	Replacement for AMG150 Filter	\$28.34
0422029	AMG-EL250	Replacement for AMG250 Filter	36.60
0422030	AMG-EL350	Replacement for AMG350 Filter	44.20
0422031	AMG-EL450	Replacement for AMG450 Filter	68.97
0422032	AMG-EL550	Replacement for AMG550 Filter	105.56
0422033	AMG-EL650	Replacement for AMG650 Filter	162.11
0422034	AMG-EL850	Replacement for AMG850 Filter	353.15

Flow Controls



Meter-Out Flow Control

- Easy installation
- Push-to-connect tube fitting
- M5 Port Connection to Elbow Tube



Part No.	Vendor No.	Tube Size	Price /Ea
0422035	AS1201F-M5-01	1/8"	\$8.84
0422036	AS1201F-M5-03	5/32"	8.84
0422037	AS1201F-M5-07	1/4"	8.84

Meter-Out Flow Control with Thread Sealant

- Easy installation
- Push-to-connect tube fitting
- Pre-applied thread sealant



Part No.	Vendor No.	NPT Size	Tube Size	Price /Ea
0422038	NAS2201F-N01-01S	1/8"	1/8"	\$14.04
0422039	NAS2201F-N01-03S	1/8"	5/32"	12.22
0422040	NAS2201F-N01-07S	1/8"	1/4"	13.13
0422041	NAS2201F-N02-03S	1/4"	5/32"	14.04
0422042	NAS2201F-N02-07S	1/4"	1/4"	14.04
0422043	NAS2201F-N02-11S	1/4"	3/8"	16.84
0422044	NAS3201F-N03-07S	3/8"	1/4"	17.75
0422045	NAS3201F-N03-11S	3/8"	3/8"	18.72
0422046	NAS4201F-N03-13S	3/8"	1/2"	43.81

Meter-In Flow Control with Thread Sealant

- Easy installation
- Push-to-connect tube fitting
- Pre-applied thread sealant



Part No.	Vendor No.	NPT Size	Tube Size	Price /Ea
0422047	NAS2211F-N01-01S	1/8"	1/8"	\$14.04
0422048	NAS2211F-N01-03S	1/8"	5/32"	12.22
0422049	NAS2211F-N01-07S	1/8"	1/4"	13.13
0422050	NAS2211F-N02-03S	1/4"	5/32"	14.04
0422051	NAS2211F-N02-07S	1/4"	1/4"	14.04
0422052	NAS2211F-N02-11S	1/4"	3/8"	16.84
0422053	NAS3211F-N03-07S	3/8"	1/4"	17.75
0422054	NAS3211F-N03-11S	3/8"	3/8"	18.72
0422055	NAS4211F-N04-13S	1/2"	1/2"	21.45

The : symbol after a price denotes that it is a Direct Ship Product (DSP) and shipping, availability & lead times may vary.

FLOW CONTROLS AND PNEUMATIC VALVES

Flow Controls Cont.



Metric Meter-Out Flow Control

- Easy installation
- Push-to-connect tube fitting
- M5 Port Connection to Elbow Tube



Part No.	Vendor No.	Tube Size	Price /Ea
0422056	AS1201F-M5-04	4mm	\$8.84

Metric Meter-Out Flow Control with Thread Sealant

- Easy installation
- Push-to-connect tube fitting
- Pre-applied thread sealant



Part No.	Vendor No.	NPT Size	Tube Size	Price /Ea
0422057	AS2201F-01-04S	1/8"	4mm	\$12.22
0422058	AS2201F-01-06S	1/8"	6mm	13.13
0422059	AS2201F-01-08S	1/8"	8mm	14.04
0422060	AS2201F-02-04S	1/4"	4mm	14.04
0422061	AS2201F-02-06S	1/4"	6mm	14.04
0422062	AS2201F-02-08S	1/4"	8mm	14.95
0422063	AS3201F-03-08S	1/4"	8mm	18.72
0422064	AS3201F-03-10S	3/8"	10mm	18.72
0422065	AS3201F-03-12S	3/8"	12mm	18.72

Tube-Tube In-Line Flow Control

Quick disconnect one-touch connections.



Part No.	Vendor No.	Tube x Tube	Price /Ea
0422066	AS1001F-01	1/8" - 1/8"	\$15.99
0422067	AS1001F-03	5/32" - 5/32"	15.99
0422069	AS2001F-07	1/4" - 1/4"	21.13
0422070	AS3001F-11	3/8" - 3/8"	31.92
0422071	AS4001F-13	1/2" - 1/2"	35.23

Metric Tube-Tube In-Line Flow Controls

Quick disconnect one-touch connections.

Part No.	Vendor No.	Tube x Tube	Price /Ea
0422068	AS1001F-04	4mm - 4mm	\$15.99
0422072	AS2001F-06	6mm - 6mm	21.13
0422073	AS3001F-08	8mm - 8mm	31.92
0422074	AS3001F-10	10mm - 10mm	31.92
0422075	AS3001F-12	12mm - 12mm	31.92



Dyla-Trol® Flow Controls

Dyla-Trol axial flow control allows fine tuning and accurate adjustment of cylinder speed. Mount as close to cylinder as possible.



Use in place of needle type flow controls for a much smoother flow.

Part No.	Vendor No.	Body Material	Port Size	Length	Max. Pressure	Max. Flow CFM	Price /Ea
0423211	MF1-02	Brass	1/4-28 male & 1/4-28 female	1-1/4"	250 Air/250 Oil	8	\$16.99
0423212	MF1-12	Aluminum	1/8 NPTF	2"	250 Air/1000 Oil	47	22.15
0423213	MF1-25	Aluminum	1/4 NPTF	2-1/2"	250 Air/1000 Oil	66	27.57
0423214	MF1-37	Aluminum	3/8 NPTF	2-7/8"	250 Air/1000 Oil	149	47.15

Pneumatic Valves



Nova Control Valves

Designed for Long Life - Nova 4-way directional control valves offer state-of-the-art air valve design at a remarkably low price. Nova utilizes a single bonded rubber spool with finely ground sealing lands that travel only .047" ...less than 1/16th of an inch! This economy of movement assures long valve life yet generates enough flow to power a 4" bore cylinder.

Large Air Flow with Dual Exhausts - 1/4" NPTF ported Nova valves produce a large output flow of 57 cubic feet per minute at 100 PSI inlet pressure ($C_V=1.0$). Each output port has its own exhaust port so that individual exhaust control is possible

Manual Override as Standard - All Nova valves are supplied with manual overrides so that valve actuation may be triggered without electricity or air to the pilots.

Single and double solenoid models available.

Part No.	Vendor No.	Type	Actuator Return	Description	Price /Ea
0423150	N2-PB	Push Button	Push Button	Holds in 2 positions	\$63.60
0423151	N2-F4	Foot Pedal	spring	Cast Alum 5 Port/4Way Foot Pedal Valve w/Guard	117.25
0423152	N2-SP	Air Pilot	spring	Cast Alum 5 Port/4Way Single Air Piloted Valve	45.91

Ergonomic Low Stress Air Valves

Ergonomically designed to respond to extremely low actuation forces, Mead's Low Stress actuators require as little as 6 ounces of force to initiate a signal. This valve will dramatically reduce the demands on your workers' hands, wrists, and arms.



LTV Low Stress valves are ported 1/8" NPT. They are shipped with a 3-way normally closed flow pattern for pilot applications, but can be easily converted to 3-way normally open or 4-way flow by removing a port plug.

Part No.	Vendor No.	Work Pressure (PSI)	Mount Style	Description	Price /Ea
0423153	LTV-PB	25 to 125psi	Side	Basic Valve (unguarded)	\$57.66
0423155	LTV-PBGF	25 to 125psi	Foot	Valve with Button Guard	66.63

Light Touch 4-way Air Valves

Mead's LTV valves are compact 1/8" ported 4-way valves that may be actuated by hand, remote air signal, electric signal, or mechanically by a machine element. They are ideal for powering small or medium sized cylinders and for piloting larger valves. Some models require as little as 4 ounces of force and .010" of plunger travel to actuate.



Part No.	Vendor No.	Type	Actuator Return	Price /Ea
0423154	LTV-TP	Two Position	Manual	\$91.86
0423156	LTV-10	Straight Leaf	Air Spring	49.55
0423157	LTV-60	Single Pressure	Air Spring	49.81
0423158	LTV-110	Double Pressure	Ext. Air Pilot	48.86

Pneumatic Valves Cont.



MICRO Line 3-way Air Switches

MV valves are identical in size and actuating style to most industrial electric limit switches. Use them in place of electrical switches to eliminate spark hazard. Unit has 1/8" NPT port size.

Part No.	Vendor No.	Type	Normally Closed Actuation Force Lbs. @ 100 PSI	Normally Open Actuation Force Lbs. @ 100 PSI	Price /Ea
0423159	MV-10	Straight Leaf	1.2	1.5	\$21.41
0423160	MV-15	Steel Roller	1.0	1.3	23.97
0423161	MV-20	1-Way Roller Leaf	29.49		
0423162	MV-45	Straight Plunger	30.18		

Binary Air Valve

USV-100 provides alternating outputs from a single input. Two outputs are selected alternately by applying a pulsing, on-off pilot signal to the input port. Unit has 5/32" tube push-in fitting included. Ports for USV-100 are 5/32" tube push-in fittings.



Part No.	Vendor No.	Description	Price /Ea
0423163	USV-100	USV-100 Aluminum Binary Alternating Air Valve	\$106.13

Easy Glide Ball Handle Valves

Low Friction Motion - MHL valves provide either 3-way pilot control (MHL-3) or 4-way directional control (MHL-4). To operate MHL valves, simply move the ball handle across the slot on the valve body. The handle rotates a precision-lapped disc to control the directional flow of air. The hardcoat anodized aluminum disc allows virtually effortless handle motion. The handle will hold in any position. Air exhausts through the disc and out to atmosphere. Unit has 1/8" NPT port size.



Easy to Mount and Repair - Base mount holes make mounting and removal quick and easy. Further, MHL valves are easy to disassemble. By simply removing the ball handle and snap ring, any part worn by use can be found and replaced.

Part No.	Vendor No.	Description	Price /Ea
0423164	MHL-3	MHL-3 Aluminum Base Mount 3-Way Easy Glide Ball Handle Valve	\$51.69
0423165	MHL-4	MHL-4 Aluminum Base Mount 4-Way Easy Glide Ball Handle Valve	59.94

Two Hand Control Valves

CSV-101 is a two-hand, anti-tie down air control.

It will actuate any 3 or 4-way air piloted, spring return power valve or small single acting cylinder. CSVs are two-hand anti-tiedown controls. When used, they provide safer operation of air presses, drill fixtures, clamping fixtures, cylinders, valves, or light assembly equipment. Models 101, 101LS, 102, 102LS, and 103 have compact and completely self-contained controls, recessed actuation buttons built in the ends and a universal mount for convenient positioning. Unit has 1/4" tube push-in fitting included.



Note: Operating pressure range is 70-120 PSI.

Part No.	Vendor No.	Description	Price /Ea
0423201	CSV-101	Steel Anti-Tiedown Two-Hand Machine Control System	\$519.02

CSV-102 is a complete power package containing a 4-way power valve ($C_v=1.00$) for direct actuation of single-acting or double acting air cylinders. Actuation sends a sustained air flow to one cylinder port. Releasing one or both buttons shifts the flow to the other cylinder port. Built-in mufflers reduce sound levels. Quick-connect fittings included. Unit has 1/8" NPT port size.



Part No.	Vendor No.	Description	Price /Ea
0423202	CSV-102	Steel Anti-Tiedown Two-Hand Machine Control System, Including 4-Way Valve	\$597.40

Quick Exhaust Valves

QEV quick exhaust valves increase cylinder speed by dumping exhaust air directly at the cylinder instead of through the control valve.



Part No.	Vendor No.	Description	Price /Ea
0423203	#1B QEV	Cast Zinc 1/4" NPT Port Mount Quick Exhaust Valve	\$19.81
0423204	#2B QEV	Cast Zinc 3/8" NPT Port Mount Quick Exhaust Valve	24.04
0423205	#3 QEV	Brass 1/8" NPT Port Mount Quick Exhaust Valve	18.35
0423206	#4 QEV	Aluminum 1/2" NPT Port Mount Quick Exhaust Valve	24.12



Knob Flow Control Valve

MASC flow control comes with knurled adjustment knob and a mounting jam nut.



Part No.	Vendor No.	Port Size	Flow Rate	Price /Ea
0423223	MASC100-06	1/8" NPT	Cv .407	\$7.04
0423224	MASC200-08	1/4" NPT	Cv .813	7.79
0423225	MASC300-10	3/8" NPT	Cv 1.524	12.20
0423226	MASC300-15	1/2" NPT	Cv 2.54	12.75

Detented Hand Lever Valves

M4H hand lever spool valve has bootied handle and is 2 position detented.



Part No.	Vendor No.	Type	Port Size	Flow Rate	Price /Ea
0423219	M4H210-06	5 Ports/2 Position/Detented	1/8" NPT	Cv .78	\$24.04
0423220	M4H310-08	5 Ports/2 Position/Detented	1/4" NPT	Cv 1.39	34.12

Foot Valves

M4F foot valve has a plastic guard with in/out port access through the rear of the unit. Exhaust mufflers are included. Unit has 1/4" NPT port size.



Part No.	Vendor No.	Description	Price /Ea
0423221	M4F210-08-G	Aluminum 5-Port/2-Position Foot Valve	\$42.10
0423222	M4F210-08-LG	Aluminum 5-Port/2-Position Foot Valve with locking foot pedal	47.60

PNEUMATIC VALVES

Pneumatic Valves Cont.



Rotary Hand Lever Valves

M4HV rotary hand valve can be either panel or base mounted. Panel mounting nut supplied.



Part No.	Vendor No.	Type	Port Size	Flow Rate	Price /Ea
0423215	M4HV310-08-S	4 Ports/2 Position	1/4" NPT	Cv .89	\$24.54
0423216	M4HV330-08-S	4 Ports/3 Position/Closed Center	1/4" NPT	Cv .89	24.54
0423217	M4HV410-15-S	4 Ports/2 Position	1/2" NPT	Cv 5.29	30.55
0423218	M4HV430-15-S	4 Ports/3 Position/Closed Center	1/2" NPT	Cv 5.29	30.55



Rotary Hand Valves

- Compact
- Low operating force
- Panel mounting available
- Die cast aluminum construction



Part No.	Vendor No.	Port Size	Description	Price /Ea
0422756	VH200-N02	1/4 NPT	3 position closed center rotary	\$57.48
0422759	VH300-N03	3/8 NPT	3 position closed center rotary	67.31
0422762	VH400-N04	1/2 NPT	3 position closed center rotary	89.01
0422757	VH201-N02	1/4 NPT	3 position exhaust center rotary	59.46
0422760	VH301-N03	3/8 NPT	3 position exhaust center rotary	73.17
0422763	VH401-N04	1/2 NPT	3 position exhaust center rotary	98.84
0422758	VH202-N02	1/4 NPT	2 position detent rotary	57.48
0422761	VH302-N03	3/8 NPT	2 position detent rotary	67.31
0422764	VH402-N04	1/2 NPT	2 position detent rotary	89.01

Check Valves Series AK

- High flow capacity
- Low cracking pressure: .02 MPa
- Compact & light weight



Part No.	Vendor No.	Port Size	Body Dia.	Price /Ea
0422975	NAK2000-N01	1/8 NPT	1/4	\$18.92
0422976	NAK2000-N02	1/4 NPT	1/4	18.92
0422977	NAK4000-N03	3/8 NPT	1/2	24.77
0422978	NAK4000-N04	1/2 NPT	1/2	24.77
0422979	NAK6000-N06	3/4 NPT	1	51.48

Residual Pressure Release 3-Port Valves

- Conforms to OSHA standards
- Key hole for lock-out
- Large knob for easy operation



Part No.	Vendor No.	Thread Size	Price /Ea
0422003	VHS20-N01-Z	1/8" NPT	\$37.84
0422004	VHS20-N02-Z	1/4" NPT	37.84
0422005	VHS30-N03-Z	3/8" NPT	40.70
0422006	VHS40-N04-Z	1/2" NPT	55.28
0422007	VHS50-N06-Z	3/4" NPT	96.80
0422008	VHS50-N10-Z	1" NPT	96.80

2 & 3 Port Mechanical Valves

UM100 Series

- Simple applications and installation
- Die cast aluminum construction
- 1/8 NPT Port Size
- 2 and 3 port versions available
- Side ported
- Includes valve and actuator



Part No.	Vendor No.	Port Size	Type	Style	Price /Ea
2 Port					
0422765	NVM120-N01-00	1/8 NPT	2-port basic actuator	Mechanical	\$11.03
0422766	NVM120-N01-08	1/8 NPT	2-port toggle lever	Manual	24.89
0422767	NVM120-N01-30B	1/8 NPT	2-port mushroom push button (black)	Manual	26.58
0422768	NVM120-N01-30R	1/8 NPT	2-port mushroom push button (red)	Manual	26.58
0422769	NVM120-N01-30G	1/8 NPT	2-port mushroom push button (green)	Manual	26.58
0422770	NVM120-N01-34B	1/8 NPT	2-port twist selector(black)	Manual	25.52
0422771	NVM120-N01-34R	1/8 NPT	2-port twist selector(red)	Manual	25.52
0422772	NVM120-N01-34G	1/8 NPT	2-port twist selector(green)	Manual	25.52
3 Port					
0422773	NVM130-N01-00	1/8 NPT	3-port basic actuator	Mechanical	11.95
0422774	NVM130-N01-05	1/8 NPT	3-port straight plunger	Mechanical	22.34
0422775	NVM130-N01-06	1/8 NPT	3-port roller plunger	Mechanical	24.60
0422776	NVM130-N01-07	1/8 NPT	3-port cross roller plunger	Mechanical	24.60
0422777	NVM130-N01-08	1/8 NPT	3-port toggle lever	Manual	25.81
0422778	NVM130-N01-30B	1/8 NPT	3-port mushroom push button (black)	Manual	27.50
0422779	NVM130-N01-30R	1/8 NPT	3-port mushroom push button (red)	Manual	27.50
0422780	NVM130-N01-30G	1/8 NPT	3-port mushroom push button (green)	Manual	27.50
0422781	NVM130-N01-34B	1/8 NPT	3-port twist selector(black)	Manual	26.44
0422782	NVM130-N01-34R	1/8 NPT	3-port twist selector(red)	Manual	26.44
0422783	NVM130-N01-34G	1/8 NPT	3-port twist selector(green)	Manual	26.44
0422784	NVM130-N01-36	1/8 NPT	3-port key selector	Manual	47.65

5 Port Mechanical Valves

VZM400 Series Base Valve

- Metal seal
- Compact design
- Large flow capacity
- 1/8 NPT main valve port
- High cycle rate, long life
- Uses same actuation designators as the 2 & 3 Port mechanical Valves



Part No.	Vendor No.	Type	Price /Ea
0422799	NVZM450-N01-00	Basic Actuator	\$53.10

Optional/Replacement Actuators

- Easy assembly to base valve
- For use with VZM400 series base valve



Part No.	Vendor No.	Type	Style	Price /Ea
0422800	VM-01CS	Hard steel roller lever	Mechanical	\$6.79
0422801	VM-02CS	Hard steel one-way roller lever	Mechanical	11.03
0422802	VM-05C	Straight plunger	Mechanical	15.06
0422803	VM-06CS	Hard steel roller plunger	Mechanical	21.14
0422804	VM-08C	Toggle lever	Manual	12.80
0422805	VM-30CB	Push button, black, (mushroom)	Manual	13.72
0422806	VM-30CR	Push button, red, (mushroom)	Manual	13.72
0422807	VM-30CG	Push button, green, (mushroom)	Manual	13.72
0422808	VM-34CB	Twist selector, black	Manual	14.21
0422809	VM-34CR	Twist selector, red	Manual	14.21
0422810	VM-34CG	Twist selector, green	Manual	14.21
0422811	VM-36C	Key selector	Manual	36.55

Pneumatic Valves Cont.



2 & 3 Port Mechanical Valves VM200 Series

Base Valves

- Large flow capacity
- 1/4 NPT port
- Use with air on inert gas
- 2 and 3 port versions available



Part No.	Vendor No.	Type	Price /Ea
0422785	NVM220-N02-00	2-port basic actuator	\$20.43
0422786	NVM230-N02-00	3-port basic actuator	21.21

Optional/Replacement Actuators

- Easy assembly to base valves
- Use with VM200 base valves



Part No.	Vendor No.	Type	Style	Price /Ea
0422787	VM-01AS	Hard steel roller lever	Mechanical	\$6.86
0422788	VM-02AS	Hard steel one-way roller lever	Mechanical	8.77
0422789	VM-05A	Straight plunger	Mechanical	13.08
0422790	VM-06AS	Hard steel roller plunger	Mechanical	16.83
0422791	VM-08A	Toggle lever	Manual	19.23
0422792	VM-30AB	Push button, black, (mushroom)	Manual	15.55
0422793	VM-30AR	Push button, red, (mushroom)	Manual	15.55
0422794	VM-30AG	Push button, green, (mushroom)	Manual	15.55
0422795	VM-34AB	Twist selector, black (2 position)	Manual	14.49
0422796	VM-34AR	Twist selector, red (2 position)	Manual	14.49
0422797	VM-34AG	Twist selector, green (2 position)	Manual	14.49
0422798	VM-36A	Key selector (2 position)	Manual	35.70

24V Direct Current Body Ported Solenoid Valve

- High flow
- Compact design
- Built-in one touch fitting
- Foot mount
- 4 way, 5 port
- 22-100 PSI



Part No.	Vendor No.	Port	Flow Rate	Price /Ea
0422812	SY3120-5LZ-N3-F1	5/32" Fitting	0.23 CV	\$69.16
0422813	SY3120-5LZ-N7-F1	1/4" Fitting	0.23CV	69.16
0422814	SY5120-5LZ-N7-F1	1/4" Fitting	0.59CV	75.13
0422815	SY5120-5LZ-N9-F1	5/16" Fitting	0.59CV	75.13
0422816	SY7120-5LZ-N9-F1	5/16" Fitting	0.9CV	84.79
0422817	SY7120-5LZ-N11-F1	3/8" Fitting	0.9CV	84.79

Base Mount Valves SY3000 Series

- 300mm Leads
- Long life to 50 million cycles
- High speed coil response times
- Low power consumption
- Space saving design
- 0.3 CV flow rate
- 10/32, 5/32, and 1/8 port sizes



Part No.	Vendor No.	Outlet	Work Pressure (PSI)	Type	Price /Ea
0422818	SY3140-5LZ		22-100 PSI	2 position Single Solenoid	\$60.75
0422819	SY3240-5LZ		15-100 PSI	2 position Double Solenoid	90.17
0422820	SY3340-5LZ		30-100 PSI	3 position, open center	103.96
0422821	SY3440-5LZ		30-100 PSI	3 position, closed center	103.96
0422822	SY3540-5LZ		30-100 PSI	3 position, pressure center	103.96
0422823	SY3140-6LZ		22-100PSI	2 position Single Solenoid	60.75
0422824	SY3240-6LZ		15-100 PSI	2 position Double Solenoid	90.17
0422825	SY3340-6LZ		30-100 PSI	3 position closed center	103.96
0422826	SY3440-6LZ		30-100 PSI	3 position open center	103.96
0422827	SY3540-6LZ		30-100 PSI	3 position pressure center	103.96

Base Mount Valve Subplate

- Easy assembly to valve
- For use with SY3000 valves



Part No.	Vendor No.	Description	Port	Price /Ea
0422828	SY3000-27-1T	Single Station Subplate	1/8 NPT	\$11.80

Valve Manifold

- Compact bar stock type
- Quick disconnect fittings
- 1/8" Inlet
- Die cast aluminum
- For use with SY3000

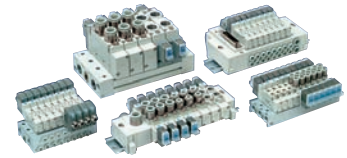

Part No.	Vendor No.	No. of Outlets	Outlet Port Size	Price /Ea
0422829	SS5Y3-41-02-N3T	2	5/32	\$40.92
0422830	SS5Y3-41-04-N3T	4	5/32	59.21
0422831	SS5Y3-41-06-N3T	6	5/32	77.49
0422832	SS5Y3-41-08-N3T	8	5/32	95.78
0422833	SS5Y3-41-02-N7T	2	1/4	40.92
0422834	SS5Y3-41-04-N7T	4	1/4	59.21
0422835	SS5Y3-41-06-N7T	6	1/4	77.49
0422836	SS5Y3-41-08-N7T	8	1/4	95.78

Blank Station Kit

Provides future expansion opportunities to existing manifold.

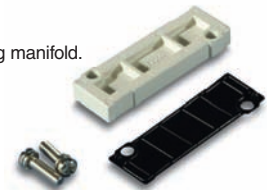

Part No.	Vendor No.	Description	Price /Ea
0422837	SY3000-26-9A	For SY3000 series manifold	\$3.10

Pilot Valve

- Space saving design
- Low power consumption
- High speed coil response times
- Long life to 50 million cycles



Part No.	Vendor No.	Description	Price /Ea
0422838	V111-5LOU	24VDC w/o leads pilot valve for SY valve series	\$26.54

Interface Regulator Kit

Provides ability to regulate pressure at individual valve station.



Part No.	Vendor No.	Description	Price /Ea
0422839	ARBY3000-05-P-2	For SY3000 series manifold	\$43.43

PNEUMATIC VALVES

Pneumatic Valves Cont.



Base Mount Valves SY5000 Series

- 300mm Leads
- Long life to 50 million cycles
- High speed coil response times
- Low power consumption
- Space saving design
- 1/8, 1/4, and 5/16 port sizes



Part No.	Vendor No.	Voltage	Type	Working Pressure (PSI)	Price /Ea
0422840	SY5140-5LZ	24VDC	2-pos. single		\$65.40
0422841	SY5240-5LZ	24VDC	2-pos. double		92.60
0422842	SY5340-5LZ	24VDC	3-pos. closed center		107.65
0422843	SY5440-5LZ	24VDC	3-pos. open center		107.65
0422844	SY5540-5LZ	24VDC	3-pos. pressure center		107.65
0422845	SY5140-6LZ	12VDC	2-pos. single		65.40
0422846	SY5240-6LZ	12VDC	2-pos. double		92.60
0422847	SY5340-6LZ	12VDC	3-pos. closed center		107.65
0422848	SY5440-6LZ	12VDC	3-pos. open center		107.65
0422849	SY5540-6LZ	12VDC	3-pos. pressure center		107.65

Base Mount Valve Subplate SY5000 Series

Easy assembly to valve.



Part No.	Vendor No.	Description	Size	Price /Ea
0422859	SY5000-27-1T	For SY5000 series	1/8" NPT base mount valve subplate for SY5000 series	\$12.90

Valve Manifold SY5000 Series

- Compact bar stock, quick disconnect fittings
- 1/4 NPTF Inlet
- For use with SY5000

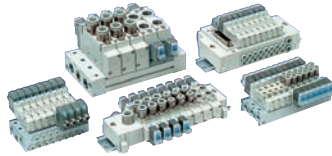

Part No.	Vendor No.	No. of Stations	Outlet Port Size	Price /Ea
0422850	SS5Y5-41-02-N7T	2	1/4	\$50.43
0422851	SS5Y5-41-04-N7T	4	1/4	71.96
0422852	SS5Y5-41-06-N7T	6	1/4	93.49
0422853	SS5Y5-41-08-N7T	8	1/4	115.02
0422854	SS5Y5-41-02-N9T	2	5/16	50.43
0422855	SS5Y5-41-04-N9T	4	5/16	71.96
0422856	SS5Y5-41-06-N9T	6	5/16	93.49
0422857	SS5Y5-41-08-N9T	8	5/16	115.02

Blank Station Kit SY5000 Series

Provides future expansion opportunities.



Part No.	Vendor No.	Description	Price /Ea
0422858	SY5000-26-20A	For SY5000 series manifold	\$5.38

Interface Regulator Kit SY5000 Series

Provides ability to regulate pressure at individual valve station.



Part No.	Vendor No.	Description	Price /Ea
0422860	ARBY5000-00-P-2	For SY5000 series manifold	\$92.97

Interface Regulator Kit

Provides ability to regulate pressure at individual valve station.



Part No.	Vendor No.	Description	Price /Ea
0422877	ARBY7000-00-P-2	For SY7000 series manifold	\$109.78

Blank Station Kit

Provides future expansion opportunities.



Part No.	Vendor No.	Description	Price /Ea
0422878	SY7000-26-22A	For SY7000 series manifold	\$5.31

Base Mount Valves SY7000 Series

- Space saving design
- Low power consumption
- High speed coil response times
- Long life to 50 million cycles
- 1/4, 5/16, and 3/8 port sizes



Part No.	Vendor No.	Voltage	Description	Working Pressure (PSI)	Price /Ea
0422861	SY7140-5LZ	24VDC	2-pos. single		\$73.73
0422862	SY7240-5LZ	24VDC	2-pos. double		101.75
0422863	SY7340-5LZ	24VDC	3-pos. closed center		117.23
0422864	SY7440-5LZ	24VDC	3-pos. open center		117.23
0422865	SY7540-5LZ	24VDC	3-pos. pressure center		117.23
0422866	SY7140-6LZ	12VDC	2-pos. single		73.73
0422867	SY7240-6LZ	12VDC	2-pos. double		101.75
0422868	SY7340-6LZ	12VDC	3-pos. closed center		117.23
0422869	SY7440-6LZ	12VDC	3-pos. open center		117.23
0422870	SY7540-6LZ	12VDC	3-pos. pressure center		117.23

Base Mount Valve Subplate

- Easy assembly to valve
- For use with SY7000 Series



Part No.	Vendor No.	Description	Size	Price /Ea
0422871	SY7000-27-1T	For SY7000 series	1/8" NPT	\$14.01
0422872	SY7000-27-2T	For SY7000 series	1/4" NPT	14.01

Valve Manifold

- Compact bar stock
- Quick disconnect fittings
- 3/8" tube fitting outlets
- For use with SY7000 Series

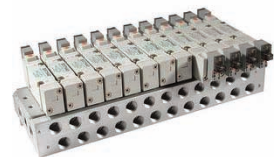

Part No.	Vendor No.	No. of Outlets	Inlet	Price /Ea
0422873	SS5Y7-42-02-N11T	2	1/4" NPTF	\$60.90
0422874	SS5Y7-42-04-N11T	4	1/4" NPTF	85.97
0422875	SS5Y7-42-06-N11T	6	1/4" NPTF	111.04
0422876	SS5Y7-42-08-N11T	8	3/8" NPTF	136.11

PNEUMATIC VALVES AND CYLINDERS

Pneumatic Valves Cont.



RuB Pneumatic and Electric Actuation Assemblies Double Acting Pneumatic Actuator and Solenoid Valve

Full line of 1/2"-2 brass ball valves direct mount to either RuB pneumatic or electric actuators. No Need for costly and space consuming bracketing/bridging. Rack and pinion pneumatic actuators in either double acting or spring (to open or close) models plus ball valves and solenoid valve to make complete assembly. RuB electric actuators in 150 and 300 in/lb models to fit 1/2"-2" ball valves. 50% duty rating and 180 degrees travel capacity.



- Full port pneumatically actuated ball valve, double acting
- Maximum 600 ps (WOG)
- Brass ball with SS trim for max life
- VT actuator has anodized aluminum body
- Solenoid valve 120VAC standard
- Direct mount for space saving operation

Part No.	Vendor No.	Description	Price
0453740	S64DDS	1/2" Brs Ball Valve-Pneumatic Actuator-Dbl Actg Solenoid Vlv	\$289.00
0453741	S64EDA	3/4" Brs Ball Valve-Pneumatic Actuator-Dbl Actg Solenoid Vlv	337.00
0453742	S64FDA	1" Brs Ball Valve-Pneumatic Actuator-Dbl Actg Solenoid Vlv	359.00
0453743	S64GDA	1-1/4" Brs Ball Valve-Pneum Actuator-Dbl Actg Solenoid Vlv	479.00
0453744	S64HDA	1-1/2" Brs Ball Valve-Pneum Actuator-Dbl Actg Solenoid Vlv	469.00
0453745	S64IDA	2" Brs Ball Valve-Pneumatic Actuator-Dbl Actg Solenoid Vlv	515.00

Spring Return Pneumatic Actuator and Solenoid Valve

Sizing based on 80 PSI air source and up to 200 PSI Delta P (pressure through valve)

Components in assembly

- S64 (39) full port
- 600 WOG
- Brass ball valve with ISO 5211 mounting pad for direct mount to actuator
- SS ball and stem for added life
- Anodized aluminum VT actuator (spring return to close valve 90 degrees (open/close) when air applied to 1/4" NPT air connection
- AD-1 Solenoid valve (air director) used NEMA 4X mounting connection, 120 VAC, 60 Hz connection



Valve connection Fip x Fip, Valve Temperature range -4°F to +350°F

- If AD-1 solenoid valve not needed in assembly, contact your Fastenal representative
- Full port pneumatically actuated ball valve, actuator, solenoid valve, and attachment screws
 - Maximum 600 psi (WOG)
 - Brass ball valve with SS trim for max life
 - VT actuator (w/springs) has anodized aluminum body
 - Solenoid valve 120 VAC standard
 - Direct mount for space saving application

Part No.	Vendor No.	Description	Price
0453746	S64DSR	1/2" Brs Ball Valve-Pneumatic Actuator-Spr Rtrn Solenoid Vlv	\$355.00
0453747	S64ESR	3/4" Brs Ball Valve-Pneumatic Actuator-Spr Rtrn Solenoid Vlv	369.00
0453748	S64FSR	1" Brs Ball Valve-Pneumatic Actuator-Spr Rtrn Solenoid Vlv	455.00
0453749	S64GSR	1-1/4" Brs Ball Valve-Pneum Actuator-Spr Rtrn Solenoid Vlv	515.00
0453750	S64ISR	1-1/2" Brs Ball Valve-Pneumatic Actuator -Spr Rtrn Solenoid Vlv	
0453751	S64ISR	2" Brs Ball Valve-Pneumatic Actuator-Spr Rtrn Solenoid Vlv	689.00

Electric Actuator

Heavy-duty electric actuators direct mounted to S64 (39) brass ball valves

Components in assembly

- S64 (39) full port
- 600 WOG
- Brass ball valve with ISO 5211 mounting pad for direct mount to actuator
- SS ball and stem for added life
- ET electric actuators have a 120 VAC, 60 Hz reversing motor in a NEMA 4 enclosure
- ISO 5211 mounting pad for compact direct mount capability
- ET actuators have a rugged corrosion-resistant construction with aluminum housing and Grade 316 Stainless Steel shaft and fasteners
- Also has manual override capability



Valve connection Fip x Fip, Valve Temperature range -4°F to +350°F

- Full port electric actuated ball valve (assembly includes brass ball valve, electric actuator, assembly screws)
- Maximum 600 psi (WOG)
- Brass ball valve with SS trim for maximum life
- ET actuator has 50% duty cycle, aluminum housing
- ET 120 VAC standard, manual override capability
- ISO 53211 direct mount for space saving performance

Part No.	Vendor No.	Description	Price
0453752	S64DET	1/2" Brass Ball Valve-SS Trim-Electric Actuator-120 VAC	\$327.00
0453753	S64EET	3/4" Brass Ball Valve-SS Trim-Electric Actuator-120 VAC	349.00
0453754	S64FET	1" Brass Ball Valve-SS Trim-Electric Actuator-120 VAC	355.00
0453755	S64GET	1-1/4" Brass Ball Valve-SS Trim-Electric Actuator-120 VAC	499.00
0453756	S64HET	1-1/2" Brass Ball Valve-SS Trim-Electric Actuator-120 VAC	535.00
0453757	S64IET	2" Brass Ball Valve-SS Trim-Electric Actuator-120 VAC	579.00

Pneumatic Cylinders



Round Body Double Acting Pneumatic Cylinders

- Non-repairable designed to last
- Permanent lube (requires no additional lubrication)
- Stainless steel tube
- Long lasting corrosion protection
- Auto switch capable
- Cushioned piston



Part No.	Vendor No.	Bore Size	Stroke Lgth.	Price /Ea
Front Nose Mount				
0422083	NCDMB075-0100C	3/4"	1"	32.94
0422084	NCDMB075-0200C	3/4"	2"	34.70
0422085	NCDMB075-0300C	3/4"	3"	36.45
0422086	NCDMB075-0400C	3/4"	4"	38.21
0422087	NCDMB075-0500C	3/4"	5"	39.96
0422088	NCDMB075-0600C	3/4"	6"	41.72
0422089	NCDMB106-0100C	1-1/16"	1"	36.86
0422090	NCDMB106-0200C	1-1/16"	2"	38.61
0422091	NCDMB106-0300C	1-1/16"	3"	40.37
0422092	NCDMB106-0400C	1-1/16"	4"	42.12
0422093	NCDMB106-0500C	1-1/16"	5"	43.88
0422094	NCDMB106-0600C	1-1/16"	6"	45.63
0422095	NCDMB125-0100C	1-1/4"	1"	48.06
0422096	NCDMB125-0200C	1-1/4"	2"	50.36
0422097	NCDMB125-0300C	1-1/4"	3"	52.65

Part No.	Vendor No.	Bore Size	Stroke Lgth.	Price /Ea
Front Nose Mount Cont.				
0422098	NCDMB125-0400C	1-1/4"	4"	54.95
0422099	NCDMB125-0500C	1-1/4"	5"	57.24
0422100	NCDMB125-0600C	1-1/4"	6"	59.54
0422101	NCDMB150-0100C	1-1/2"	1"	56.57
0422102	NCDMB150-0200C	1-1/2"	2"	59.40
0422103	NCDMB150-0300C	1-1/2"	3"	62.24
0422104	NCDMB150-0400C	1-1/2"	4"	65.07
0422105	NCDMB150-0500C	1-1/2"	5"	67.91
0422106	NCDMB150-0600C	1-1/2"	6"	70.74
0422107	NCDMB200-0100C	2"	1"	74.18
0422108	NCDMB200-0200C	2"	2"	77.15
0422109	NCDMB200-0300C	2"	3"	80.12
0422110	NCDMB200-0400C	2"	4"	83.09
0422111	NCDMB200-0500C	2"	5"	86.91
0422112	NCDMB200-0600C	2"	6"	89.03
Rear Pivot Mount				
0422113	NCDMC075-0100C	3/4"	1"	37.13
0422114	NCDMC075-0200C	3/4"	2"	38.88
0422115	NCDMC075-0300C	3/4"	3"	40.64
0422116	NCDMC075-0400C	3/4"	4"	42.39
0422117	NCDMC075-0500C	3/4"	5"	44.15
0422118	NCDMC075-0600C	3/4"	6"	45.90
0422119	NCDMC106-0100C	1-1/16"	1"	41.45
0422120	NCDMC106-0200C	1-1/16"	2"	43.20
0422121	NCDMC106-0300C	1-1/16"	3"	44.96
0422122	NCDMC106-0400C	1-1/16"	4"	46.71
0422123	NCDMC106-0500C	1-1/16"	5"	48.47

The : symbol after a price denotes that it is a Direct Ship Product (DSP) and shipping, availability & lead times may vary.

PNEUMATIC CYLINDERS

Pneumatic Cylinders Cont.



Pneumatic Valves & Accessories

Part No.	Vendor No.	Bore Size	Stroke Lgth.	Price /Ea
Rear Pivot Mount Cont.				
0422124	NCDMC106-0600C	1-1/16"	6"	\$50.22
0422125	NCDMC125-0100C	1-1/4"	1"	53.06
0422126	NCDMC125-0200C	1-1/4"	2"	55.35
0422127	NCDMC125-0300C	1-1/4"	3"	57.65
0422128	NCDMC125-0400C	1-1/4"	4"	59.94
0422129	NCDMC125-0500C	1-1/4"	5"	62.24
0422130	NCDMC125-0600C	1-1/4"	6"	64.53
0422131	NCDMC150-0100C	1-1/2"	1"	62.57
0422132	NCDMC150-0200C	1-1/2"	2"	65.41
0422133	NCDMC150-0300C	1-1/2"	3"	68.24
0422134	NCDMC150-0400C	1-1/2"	4"	71.08
0422135	NCDMC150-0500C	1-1/2"	5"	73.91
0422136	NCDMC150-0600C	1-1/2"	6"	76.75

Spring Acting Spring Return Cylinders

- Non-repairable designed to last
- Permanent lube (requires no additional lubrication)
- Stainless steel tube
- Long lasting corrosion protection
- Auto switch capable



Part No.	Vendor No.	Bore Size	Stroke Lgth.	Price /Ea
Front Nose Mount				
0422137	NCDMB075-0100S	3/4"	1"	\$27.81
0422138	NCDMB075-0200S	3/4"	2"	30.51
0422139	NCDMB075-0300S	3/4"	3"	33.21
0422140	NCDMB106-0100S	1-1/16"	1"	30.85
0422141	NCDMB106-0200S	1-1/16"	2"	34.16
0422142	NCDMB106-0300S	1-1/16"	3"	37.46
0422143	NCDMB125-0200S	1-1/4"	2"	46.71
0422144	NCDMB150-0100S	1-1/2"	1"	49.55
0422145	NCDMB150-0200S	1-1/2"	2"	54.54
0422146	NCDMB150-0300S	1-1/2"	3"	59.94
Rear Pivot Mount				
0422147	NCDMC075-0100S	3/4"	1"	\$32.13
0422148	NCDMC075-0200S	3/4"	2"	34.83
0422149	NCDMC106-0100S	1-1/16"	1"	35.24
0422150	NCDMC106-0200S	1-1/16"	2"	38.54
0422151	NCDMC125-0200S	1-1/4"	2"	51.50
0422152	NCDMC150-0200S	1-1/2"	2"	60.28

Repairable Round Body Cylinders

NCG Series

- High speed operation to 40in/sec
- Basic mount
- Engineered piston assembly
- Removable rod cover allows easy seal replacement
- Can be integrated with linear guides



Part No.	Vendor No.	Bore Size	Stroke Lgth.	Price /Ea
0422153	NCDGBN25-0100	1"	1"	\$46.71
0422154	NCDGBN25-0150	1"	1-1/2"	48.67
0422155	NCDGBN25-0200	1"	2"	48.67
0422156	NCDGBN25-0250	1"	2-1/2"	50.63
0422157	NCDGBN25-0300	1"	3"	50.63
0422158	NCDGBN25-0400	1"	4"	52.58
0422159	NCDGBN25-0500	1"	5"	54.54
0422160	NCDGBN25-0600	1"	6"	56.50
0422161	NCDGBN40-0100	1-1/2"	1"	68.58
0422162	NCDGBN40-0150	1-1/2"	1-1/2"	71.21
0422163	NCDGBN40-0200	1-1/2"	2"	71.21
0422164	NCDGBN40-0250	1-1/2"	2-1/2"	73.85
0422165	NCDGBN40-0300	1-1/2"	3"	73.85
0422166	NCDGBN40-0400	1-1/2"	4"	76.48
0422167	NCDGBN40-0500	1-1/2"	5"	79.11
0422168	NCDGBN40-0600	1-1/2"	6"	81.74
0422169	NCDGBN50-0100	2"	1"	89.71
0422170	NCDGBN50-0150	2"	1-1/2"	93.08
0422171	NCDGBN50-0200	2"	2"	93.08
0422172	NCDGBN50-0250	2"	2-1/2"	96.46
0422173	NCDGBN50-0300	2"	3"	96.46
0422174	NCDGBN50-0400	2"	4"	99.83
0422175	NCDGBN50-0500	2"	5"	103.21
0422176	NCDGBN50-0600	2"	6"	106.58
0422177	NCDGBN63-0100	2-1/2"	1"	114.95
0422178	NCDGBN63-0150	2-1/2"	1-1/2"	118.73
0422179	NCDGBN63-0200	2-1/2"	2"	118.73
0422180	NCDGBN63-0250	2-1/2"	2-1/2"	122.51
0422181	NCDGBN63-0300	2-1/2"	3"	122.51
0422182	NCDGBN63-0400	2-1/2"	4"	126.29
0422183	NCDGBN63-0500	2-1/2"	5"	130.07
0422184	NCDGBN63-0600	2-1/2"	6"	133.85

Foot Mounting Kits

Foot mounting brackets for NCG Series Cylinders.



Part No.	Vendor No.	Description	Bore Size	Price /Ea
0422185	NCG-L025	NCG25 Foot mounting kit	25 mm	\$4.40
0422186	NCG-L040	NCG40 Foot mounting kit	40 mm	5.32
0422187	NCG-L050	NCG50 Foot mounting kit	50 mm	5.78
0422188	NCG-L063	NCG63 Foot mounting kit	63 mm	10.83

PNEUMATIC CYLINDERS & MUFFLERS

Pneumatic Cylinders Cont.



NFPA Interchangeable Cylinders NCAI Series

- Compact and lightweight rolled piston threads
- Increased kinetic energy absorption
- Rugged square covers
- Switch capable
- Tie-Rod Style
- Basic Mount



Part No.	Vendor No.	Bore Size	Stroke Lgth.	Price /Ea
0422189	NCDA1B150-0100	1-1/2"	1	\$117.13
0422190	NCDA1B150-0200	1-1/2"	2	120.45
0422191	NCDA1B150-0300	1-1/2"	3	123.76
0422192	NCDA1B150-0400	1-1/2"	4	127.08
0422193	NCDA1B150-0500	1-1/2"	5	130.39
0422194	NCDA1B200-0100	2"	1	128.83
0422195	NCDA1B200-0200	2"	2	132.47
0422196	NCDA1B200-0300	2"	3	136.11
0422197	NCDA1B200-0400	2"	4	139.75
0422198	NCDA1B200-0500	2"	5	143.39
0422199	NCDA1B250-0100	2-1/2"	1	140.53
0422200	NCDA1B250-0200	2-1/2"	2	144.50
0422201	NCDA1B250-0300	2-1/2"	3	148.46
0422202	NCDA1B250-0400	2-1/2"	4	152.43
0422203	NCDA1B250-0500	2-1/2"	5	156.39
0422204	NCDA1B325-0100	3-1/4"	1	228.35
0422205	NCDA1B325-0200	3-1/4"	2	233.48
0422206	NCDA1B325-0300	3-1/4"	3	238.62
0422207	NCDA1B325-0400	3-1/4"	4	243.75
0422208	NCDA1B325-0500	3-1/4"	5	248.89
0422209	NCDA1B400-0100	4"	1	253.37
0422210	NCDA1B400-0200	4"	2	259.48
0422211	NCDA1B400-0300	4"	3	265.59
0422212	NCDA1B400-0400	4"	4	271.70
0422213	NCDA1B400-0500	4"	5	277.81

Through Hole Mount Compact Cylinders NC DQ 8 Series

- Compact design for close center to center mounting
- Extruded aluminum body
- Hard anodized
- Auto switch capable



Part No.	Vendor No.	Bore Size	Stroke Lgth.	Price /Ea
0422226	NCQ8B056-012	9/16"	1/8"	\$41.28
0422227	NCDQ8B056-025	9/16"	1/4"	47.91
0422228	NCDQ8B056-050	9/16"	1/2"	48.43
0422229	NCDQ8B056-075	9/16"	3/4"	48.95
0422230	NCDQ8B056-100	9/16"	1"	49.47
0422231	NCDQ8B056-150	9/16"	1-1/2"	50.51
0422232	NCDQ8B056-200	9/16"	2"	51.55
0422233	NCDQ8B056-250	9/16"	2-1/2"	52.59
0422234	NCDQ8B056-300	9/16"	3"	53.63
0422235	NCDQ8B056-350	9/16"	3-1/2"	54.67
0422236	NCDQ8B056-400	9/16"	4"	55.71
0422237	NCDQ8B075-025	3/4"	1/4"	49.27
0422238	NCDQ8B075-050	3/4"	1/2"	49.79
0422239	NCDQ8B075-100	3/4"	1"	50.83
0422240	NCDQ8B075-200	3/4"	2"	52.91
0422241	NCDQ8B075-300	3/4"	3"	54.99
0422242	NCDQ8B075-400	3/4"	4"	57.07
0422243	NCDQ8B150-100	1-1/2"	1"	79.04
0422244	NCDQ8B150-200	1-1/2"	2"	83.20
0422245	NCDQ8B150-300	1-1/2"	3"	87.36
0422246	NCDQ8B150-400	1-1/2"	4"	91.52
0422247	NCDQ8B200-100	2"	1"	97.37
0422248	NCDQ8B200-200	2"	2"	103.61
0422249	NCDQ8B200-300	2"	3"	109.85
0422250	NCDQ8B200-400	2"	4"	116.09
0422251	NCDQ8B250-100	2-1/2"	1"	127.08
0422252	NCDQ8B250-200	2-1/2"	2"	134.88
0422253	NCDQ8B250-300	2-1/2"	3"	142.68
0422254	NCDQ8B250-400	2-1/2"	4"	150.48

The : symbol after a price denotes that it is a Direct Ship Product (DSP) and shipping, availability & lead times may vary.

NCA1 Mounting Kits

- Quick and easy assembly
- For use with NCAI Series Cylinders



Part No.	Vendor No.	Bore Size	Style	Description	Price /Ea
0422214	NCA1-C200	2"	Single Detachable	2" Single detachable Rear Clevis Mounting Kit (MP4)	\$11.83
0422218	NCA1-D200	2"	Double Detachable	2" Double detachable Rear Clevis Mounting Kit (MP2)	11.83
0422222	NCA1-F200	2"	Front Flange	2" Front Flange Mounting Kit (MF1)	12.87
0422215	NCA1-C250	2-1/2"	Single Detachable	2.5" Single detachable Rear Clevis Mounting Kit (MP4)	12.55
0422219	NCA1-D250	2-1/2"	Double Detachable	2.5" Double detachable Rear Clevis Mounting Kit (MP2)	12.55
0422223	NCA1-F250	2-1/2"	Front Flange	2.5" Front Flange Mounting Kit (MF1)	16.45
0422216	NCA1-C325	3-1/4"	Single Detachable	3.25" Single detachable Rear Clevis Mounting Kit (MP4)	22.10
0422220	NCA1-D325	3-1/4"	Double Detachable	3.25" Double detachable Rear Clevis Mounting Kit (MP2)	22.10
0422224	NCA1-F325	3-1/4"	Front Flange	3.25" Front Flange Mounting Kit (MF1)	26.39
0422217	NCA1-C400	4"	Single Detachable	4" Single detachable Rear Clevis Mounting Kit (MP4)	25.68
0422221	NCA1-D400	4"	Double Detachable	4" Double detachable Rear Clevis Mounting Kit (MP2)	25.68
0422225	NCA1-F400	4"	Front Flange	4" Front Flange Mounting Kit (MF1)	32.76

Mufflers and Vents



Silencer/Exhaust Mufflers

High decibel reduction.



Part No.	Vendor No.	Thread Size	Price /Ea
0422076	NAN200-N02	1/4 NPT	\$5.49
0422077	NAN300-N03	3/8 NPT	5.92
0422078	AN400-N04	1/2 NPT	6.44
0422079	NAN500-N06	3/4 NPT	19.96
0422080	NAN600-N10	1 NPT	24.25

Sintered Metal Silencer/Exhaust Mufflers

High decibel reduction.



Part No.	Vendor No.	Thread Size	Price /Ea
0422081	AN120-M5	M5	\$3.29
0422082	NAN110-N01	1/8 NPT	5.46



Sintered Mufflers



Size	Length	Hex	Part No.	Price /Each
10/32	45/64	5/16	0469590	\$2.39
1/8	1-1/8	7/16	0469591	2.95
1/4	1-3/8	9/16	0469592	2.99
3/8	1-1/2	11/16	0469593	4.49
1/2	1-7/8	7/8	0469594	6.29
3/4	2-1/4	1-1/16	0469595	9.75
1	2-7/8	1-5/16	0469596	14.75
1-1/4	3-1/4	1-11/16	0469597	23.75

MUFFLERS, VENTS, MANIFOLDS & TUBING

Mufflers and Vents Cont.



Speed Control Mufflers



Size	Length	Hex	Part No.	Price /Each
1/8	1-5/16	1/2	0469607	\$5.94
1/8	1-9/16	9/16	0469608	6.95
1/4	1-9/16	9/16	0469609	6.95
1/4	1-5/8	11/16	0469610	7.45
3/8	1-5/8	11/16	0469611	7.79
3/8	2	7/8	0469612	10.95
1/2	2	7/8	0469613	10.75
1/2	2-3/8	1-1/16	0469614	17.97
3/4	2-3/8	1-1/16	0469615	17.97
1	2-1/2	1-5/16	0469616	24.95

Breather Vents



Size	Length	Hex	Part No.	Price /Each
1/8	7/16	7/16	0469599	\$1.75
1/4	5/8	9/16	0469600	2.25
3/8	3/4	11/16	0469601	2.95
1/2	7/8	7/8	0469602	4.55
3/4	1	1-1/16	0469603	6.55
1	1-5/16	1-5/16	0469604	9.25
1-1/4	1-13/32	1-11/16	0469605	18.75
1-1/2	1-1/2	2	0469606	17.99

Pneumatic Accessories



Rack and Pinion Rotary Actuators

- Compact and lightweight
- Auto switch capable
- 90° or 180° rotation



Part No.	Vendor No.	Bore Size	Description	Price /Ea
0422750	NCDRA1BW30-90	30mm	90° rack and pinion rotary actuator	\$295.50
0422751	NCDRA1BW30-180	30mm	180° rack and pinion rotary actuator	295.50
0422752	NCDRA1BS63-90C	63mm	90° rack and pinion rotary actuator	567.50
0422753	NCDRA1BS63-180C	63mm	180° rack and pinion rotary actuator	567.50
0422754	NCDRA1BS80-90C	80mm	90° rack and pinion rotary actuator	699.00
0422755	NCDRA1BS80-180C	80mm	180° rack and pinion rotary actuator	699.00



Master WAIRhouse®
Quality Power Products

Aluminum Manifold Blocks

- Made from Precision Extruded Aluminum
- Black anodized finish



Part No.	Vendor No.	Inlet	Port Size	No. of Outlets	Price /Ea
0423000	PCM10-125-02B	1/4" NPT	1/8" NPT	2	\$15.85
0423002	PCM10-125-04B	1/4" NPT	1/8" NPT	4	17.25
0423004	PCM10-125-06B	1/4" NPT	1/8" NPT	6	22.25
0423006	PCM10-125-08B	1/4" NPT	1/8" NPT	8	24.65
0423008	PCM10-125-10B	1/4" NPT	1/8" NPT	10	27.47
0423009	PCM20-250-02B	3/8" NPT	1/4" NPT	2	17.98
0423011	PCM20-250-04B	3/8" NPT	1/4" NPT	4	21.20
0423013	PCM20-250-06B	3/8" NPT	1/4" NPT	6	23.98
0423015	PCM20-250-08B	3/8" NPT	1/4" NPT	8	26.88
0423017	PCM20-250-10B	3/8" NPT	1/4" NPT	10	28.94
0423018	PCM30-375-02B	1/2" NPT	3/8" NPT	2	26.92
0423020	PCM30-375-04B	1/2" NPT	3/8" NPT	4	29.99
0423022	PCM30-375-06B	1/2" NPT	3/8" NPT	6	32.99
0423024	PCM30-375-08B	1/2" NPT	3/8" NPT	8	44.46
0423026	PCM30-375-10B	1/2" NPT	3/8" NPT	10	46.49



Fractional Nylon Tubing

- Dimensional stability
- Low moisture absorption
- Elastic memory
- Wide temperature range
- Many color options



Part No.	Vendor No.	Tube O.D.	Length	Color	Price /Roll
0422900	TIA01B-33	1/8"	100 feet	Black	\$16.50
0422901	TIA01BU-33	1/8"	100 feet	Blue	16.50
0422902	TIA01R-33	1/8"	100 feet	Red	16.50
0422903	TIA01G-33	1/8"	100 feet	Green	16.50
0422904	TIA05B-33	3/16"	100 feet	Black	18.25
0422905	TIA05BU-33	3/16"	100 feet	Blue	18.25
0422906	TIA05R-33	3/16"	100 feet	Red	18.25
0422907	TIA05G-33	3/16"	100 feet	Green	18.25
0422908	TIA07B-33	1/4"	100 feet	Black	29.25
0422909	TIA07BU-33	1/4"	100 feet	Blue	29.25
0422910	TIA07R-33	1/4"	100 feet	Red	29.25
0422911	TIA07G-33	1/4"	100 feet	Green	29.25
0422912	TIA11B-33	3/8"	100 feet	Black	61.75
0422913	TIA11BU-33	3/8"	100 feet	Blue	61.75

Metric Nylon Tubing

- Dimensional stability
- Low moisture absorption
- Elastic memory
- Wide temperature range
- Many color options



Part No.	Vendor No.	Tube O.D.	Length	Color	Price /Ea
0422931	T0425B-20	4mm	20 meters	Black	\$12.05
0422932	T0425BU-20	4mm	20 meters	Blue	12.05
0422933	T0604B-20	6mm	20 meters	Black	21.80
0422934	T0604BU-20	6mm	20 meters	Blue	21.80
0422935	T0806B-20	8mm	20 meters	Black	33.80
0422936	T0806BU-20	8mm	20 meters	Blue	33.80
0422937	T1209B-20	12mm	20 meters	Black	71.35
0422938	T1209BU-20	12mm	20 meters	Blue	71.35

Pneumatic Accessories Cont.



Fractional Polyurethane Tubing

- Cut resistant
- Kink resistant
- Extremely flexible
- Good chemical resistance
- Many colors available



Part No.	Vendor No.	Tube O.D.	Length	Color	Price /Ea
0422914	TIUB01B-33	1/8"	100 feet	Black	\$14.55
0422915	TIUB01BU-33	1/8"	100 feet	Blue	14.55
0422916	TIUB01C-33	1/8"	100 feet	Clear	14.55
0422917	TIUB01R-33	1/8"	100 feet	Red	14.55
0422918	TIUB01G-33	1/8"	100 feet	Green	14.55
0422919	TIUB07B-33	1/4"	100 feet	Black	38.28
0422920	TIUB07BU-33	1/4"	100 feet	Blue	38.28
0422921	TIUB07C-33	1/4"	100 feet	Clear	38.28
0422922	TIUB07R-33	1/4"	100 feet	Red	38.28
0422923	TIUB07G-33	1/4"	100 feet	Green	38.28
0422924	TIUB11B-33	3/8"	100 feet	Black	74.58
0422925	TIUB11BU-33	3/8"	100 feet	Blue	74.58
0422926	TIUB11C-33	3/8"	100 feet	Clear	74.58
0422927	TIUB11R-33	3/8"	100 feet	Red	74.58
0422928	TIUB11G-33	3/8"	100 feet	Green	74.58
0422929	TIUB13B-33	1/2"	100 feet	Black	130.35
0422930	TIUB13BU-33	1/2"	100 feet	Blue	130.35

Tube Cutter

- Long lasting and durable
- Provides square cuts
- Plier style



Part No.	Vendor No.	Description	Tube Size	Price /Ea
0422939	TK-1	Tube cutter	Up to 13mm (1/2")	\$45.50

Multiple Tube Holders

- Great for organizing and labeling tube leads
- Black Polypropylene



Part No.	Vendor No.	No. of Openings	Tube O.D.	Price /Ea
0422940	TM-04	12	4mm	\$2.73
0422941	TM-06	12	6mm	2.73
0422942	TM-08	8	8mm	2.73
0422943	TM-12	6	12mm	5.45

Digital Pressure/Vacuum Switches

- 2 meter lead wire with connector
- Dual color red and green display
- User friendly with controls
- 1/8" NPT port



Part No.	Vendor No.	Type	Style	Price /Ea
0422960	ISE30-T1-25-L	Pressure	NPN	\$169.50
0422961	ISE30-T1-65-L	Pressure	PNP	169.50
0422962	ZSE30-T1-25-L	Vacuum	NPN	169.50
0422963	ZSE30-T1-65-L	Vacuum	PNP	169.50

Vacuum Ejector

- Turns positive pressure into vacuum
- Up to 26" Hg
- Simple vacuum ejector
- Compact and lightweight
- Solid resin material



Part No.	Vendor No.	Type	Nozzle Size	Port Size	Flow Rate	Price /Ea
0422966	NZHI07BS-T01-T01	Box Type	.7	1/8-1/4	0.71 SCFM	\$36.05
0422967	NZHI07DS-07-07-07	Body Ported	.7	1/8-1/4	0.71 SCFM	24.39
0422968	NZHI10BS-T01-T01	Compact	1.0	1/8-1/4	1.20 SCFM	38.65
0422969	NZHI10DS-07-07-09	Body Ported	1.0	1/4	1.20 SCFM	27.31
0422970	NZHI13BS-T01-T02	Compact	1.3	1/8-1/4	2.48 SCFM	43.99
0422971	NZHI13DS-09-11-11	Body Ported	1.3	5/16-3/8	2.48 SCFM	29.93

Multistage Vacuum Ejector with Built-In Exhaust Silencer

- 10 ft. lead wire
- Compact vacuum ejector with built in silencer
- 1/4" to 1/2" fittings
- 30-70 psi working pressure
- 3.54 SCFM flow rate



Part No.	Vendor No.	Style	Price /Ea
0422964	ZL112-E25L	NPN	\$493.76
0422965	ZL112-E65L	PNP	504.99

Air Suction Filter

- Long life
- Easy maintenance
- Built-in quick connect fittings
- Protects vacuum equipment from airborne contaminant's



Part No.	Vendor No.	Size	Price /Ea
0422972	ZFB101-05	3/16" in/out	\$16.50
0422973	ZFB201-07	1/4" in/out	20.75
0422974	ZFB301-11	3/8" in/out	23.72



Single Acting Air Clamps

Economical single-acting air clamps provide gripping power on the out stroke and spring retraction. They are ideal for use in drill fixtures and for bending, swaging, forming, crimping, and pressing operations. Because 3-way valves may be used, hook-ups are quick and easy.

HIX12 is supplied with an adjustable front head so that the user may adjust the length of the stroke by as much as one inch.

H-1 is horizontal mount and V-1 is vertical mount

Part No.	Vendor No.	Bore Size	Stroke Lgth.	Output	Price /Ea
0423192	H-1	1"	11/16"	68	\$26.57
0423193	HIX12	1"	1" to 2" adj	68	62.59
0423194	V-1	1"	11/16"	61	26.57

Note: Max. Output @ 100 PSI

Air Timers

KLC air timers are adjustable and used to delay an air signal. Normally closed. Yellow dot on timer is input port. Port size 1/8" NPT.

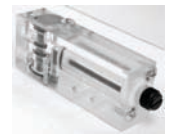

Time delay:

KLC-105, 75 to 6 sec.

KLC-110, 1 to 11 sec.

KLC-230, 2 to 30 sec.

Part No.	Vendor No.	Description	Time Delay	Price /Ea
0423195	KLC-105	KLC-105 Acrylic Normally Closed Air Timer Delay Signal	75 to 6 sec.	\$97.41
0423196	KLC-110	KLC-110 Acrylic Normally Closed Air Timer Delay Signal	1 to 11 sec.	97.41
0423197	KLC-230	KLC-230 Acrylic Normally Closed Air Timer Delay Signal	2-30 sec.	97.41

Pneumatic Stroke Completion Sensors

Stroke Completion Sensors (SCS) mount directly on cylinder ports to provide an air signal when rod motion stops...even when the full stroke length is not used. Stroke completion sensors automatically adjust to variable strokes, replacing limit and reed switches in clamping, holding, and sequencing tasks.



Sensors work by comparing supply pressure to exhaust pressure. Once the pressure drops on the exhaust side of the cylinder, the sensor will emit an air signal. Stroke completion sensors are not recommended for cylinder "inching" operations with pressure held valves.

Part No.	Vendor No.	Port Size	Tube O.D.	Pressure Range	Price /Ea
0423198	SCS-250	1/4" NPT	5/32	60-120 PSI	\$60.75
0423199	SCS-375	3/8" NPT	5/32	60-120 PSI	60.75

DRY FACE GAUGES

Pneumatic Accessories Cont.



Air to Electric Switch

Air to electric switches convert air signals into electrical signals...ideal for actuating solenoid power valves or other electric components. Switches may be wired normally closed or normally open.

Model MPE-BZ is a single pull double throw (SPDT), has a 15 amp capacity for normal, low resistance electrical circuits and is UL and CSA listed. Solder terminals accept up to #14 wire.



Part No.	Vendor No.	Description	Price /Ea
0423200	MPE-BZ	Aluminum Air-To-Electric Actuator head and 15 amp switch	\$69.36

Mini Regulator

- MSR mini-regulator is a relieving type with a locking knob
- Comes with a gauge and mounting bracket
- Pressure range 8-130 psi
- Max pressure 145 psi



Part No.	Vendor No.	Description	Port Size	Price /Ea
0423227	MSR200-06	Aluminum Miniature Bracket Relieving Regulator	1/8" NPT	\$19.25
0423228	MSR200-08	Aluminum Miniature Bracket Relieving Regulator	1/4" NPT	19.25

Dry Face Gauges



2" Gauge 101D 1/4" Lower Mount

- Black steel case with chrome bezel
- Dry non-fillable
- Brass connection and internals



0490528

Part No.	Description	Price /Each
0490528	30" Hg-0	\$7.67
0490529	0-15 psi	7.67
0490530	0-30 psi	6.28
0490531	0-60 psi	6.28
0490532	0-100 psi	6.28
0490533	0-160 psi	6.28
0490534	0-200 psi	6.28
0490535	0-300 psi	6.28

2-1/2" Gauge

101D 1/4" Lower Mount

- Black steel case with chrome bezel
- Dry non-fillable
- Brass connection and internals



0490528

Part No.	Description	Price /Each
0490536	30" Hg-0	\$9.91
0490537	0-15 psi	9.91
0490538	0-30 psi	9.91
0490539	0-60 psi	8.31
0490540	0-100 psi	8.31
0490541	0-160 psi	8.31
0490542	0-200 psi	8.31
0490543	0-300 psi	8.31
0490544	0-400 psi	9.59
0490545	0-600 psi	9.59
0490546	0-1000 psi	9.59

3-1/2" Gauge

101D 1/4" Lower Mount

- Black steel case with chrome bezel
- Dry non-fillable
- Brass connection and internals



0490528

Part No.	Description	Price /Each
0490547	30" Hg-0	\$15.81
0490548	0-15 psi	15.81
0490549	0-30 psi	14.73
0490550	0-60 psi	14.73
0490551	0-100 psi	14.73
0490552	0-160 psi	14.73
0490553	0-200 psi	14.73
0490554	0-300 psi	14.73
0490555	0-400 psi	15.81
0490556	0-600 psi	15.81
0490557	0-1000 psi	15.81

1-1/2" Gauge

102D 1/8" Center Back Mount

- Black steel case with chrome bezel
- Dry non-fillable
- Brass connection and internals



Part No.	Description	Price /Each
0490558	30" Hg-0	\$7.88
0490559	0-15 psi	7.88
0490560	0-30 psi	7.24
0490561	0-60 psi	7.24
0490562	0-100 psi	7.24
0490563	0-160 psi	7.24
0490564	0-200 psi	7.24
0490565	0-300 psi	7.24

DRY FACE GAUGES & LIQUID FILLED GAUGES

Dry Face Gauges Cont.

2" Gauge 102D 1/4" Center Back Mount

- Black steel case with chrome bezel
- Dry non-fillable
- Brass connection and internals



Part No.	Description	Price /Each
0490566	30" Hg-0	\$7.88
0490567	0-15 psi	7.88
0490568	0-30 psi	7.24
0490569	0-60 psi	7.24
0490570	0-100 psi	7.24
0490571	0-160 psi	7.24
0490572	0-200 psi	7.24
0490573	0-300 psi	7.24

2-1/2" Gauge 102D 1/4" Center Back Mount

- Black steel case with chrome bezel
- Dry non-fillable
- Brass connection and internals



Part No.	Description	Price /Each
0490574	30" Hg-0	\$10.98
0490575	0-15 psi	10.98
0490576	0-30 psi	11.52
0490577	0-60 psi	11.52
0490578	0-100 psi	11.52
0490579	0-160 psi	11.52
0490580	0-200 psi	11.52
0490581	0-300 psi	11.52
0490582	0-400 psi	12.38
0490583	0-600 psi	12.38
0490584	0-1000 psi	12.38

Liquid Filled Gauges



2-1/2" Gauge 201L 1/4" Lower Mount

- Stainless steel case and bezel
- Brass internals and connection
- Liquid filled
- Plastic lens



Part No.	Description	Price /Each
0490585	30" Hg-0	\$17.95
0490586	0-15 psi	17.95
0490587	0-30 psi	17.95
0490588	0-60 psi	17.95
0490589	0-100 psi	17.95
0490590	0-160 psi	17.95
0490591	0-200 psi	17.95
0490592	0-300 psi	17.95
0490593	0-400 psi	17.95
0490594	0-500 psi	17.95
0490595	0-600 psi	17.95
0490596	0-1000 psi	17.95
0490597	0-1500 psi	17.95
0490598	0-2000 psi	17.95
0490599	0-3000 psi	17.95
0490600	0-5000 psi	17.95
0490601	0-6000 psi	17.95
0490602	0-10000 psi	19.29
0490603	0-15000 psi	19.29

2-1/2" Gauge 202L 1/4" Center Back Mount

- Stainless steel case and bezel
- Brass internals and connection
- Liquid filled
- Plastic lens



Part No.	Description	Price /Each
0490604	30" Hg-0	\$19.90
0490605	0-15 psi	19.90
0490606	0-30 psi	19.90
0490607	0-60 psi	19.90
0490608	0-100 psi	19.90
0490609	0-160 psi	19.90
0490610	0-200 psi	19.90
0490611	0-300 psi	19.90
0490612	0-400 psi	19.90
0490613	0-600 psi	19.90
0490614	0-1000 psi	19.90
0490615	0-1500 psi	19.90
0490616	0-2000 psi	19.90
0490617	0-3000 psi	19.90
0490618	0-5000 psi	19.90
0490619	0-6000 psi	19.90
0490620	0-10000 psi	21.96
0490621	0-15000 psi	21.96

4" Dial Liquid Filled Gauge - 1/4" Lower Mount

- Stainless Steel Case
- Brass Internals and Connection
- Glycerine Filled
- Plastic Lens



Part No.	Pressure Range	Price /Ea
0440553	30" Hg-0	\$35.50
0440554	0-15 psi	35.50
0440555	0-30 psi	35.50
0440556	0-60 psi	35.50
0440557	0-100 psi	35.50
0440558	0-160 psi	35.50
0440559	0-200 psi	35.50
0440560	0-300 psi	35.50
0440561	0-400 psi	35.50
0440562	0-500 psi	35.50
0440563	0-600 psi	35.50
0440564	0-1000 psi	35.50
0440565	0-1500 psi	35.50
0440566	0-2000 psi	35.50
0440567	0-3000 psi	35.50
0440568	0-5000 psi	35.50
0440569	0-6000 psi	35.50
0440570	0-10000 psi	35.50
0440571	0-15000 psi	35.50

4" Dial Liquid Filled Gauge - 1/2" Lower Mount

- Stainless Steel Case
- Brass Internals and Connection
- Glycerine Filled
- Plastic Lens



Part No.	Pressure Range	Price /Ea
0440572	30" Hg-0 (Vac)	\$35.50
0440573	0-15 psi	35.50
0440574	0-30 psi	35.50
0440575	0-60 psi	35.50
0440576	0-100 psi	35.50
0440577	0-160 psi	35.50
0440578	0-200 psi	35.50
0440579	0-300 psi	35.50
0440580	0-400 psi	35.50
0440581	0-500 psi	35.50
0440582	0-600 psi	35.50
0440583	0-1000 psi	35.50
0440584	0-1500 psi	35.50
0440585	0-2000 psi	35.50
0440586	0-3000 psi	35.50
0440587	0-5000 psi	35.50
0440588	0-6000 psi	35.50
0440589	0-10000 psi	35.50
0440590	0-15000 psi	35.50

2.5" Dial All Stainless Gauge - Liquid Filled - 1/4" Lower Mount

- 316L Stainless Steel Internals and Connection
- Stainless Steel Case - Liquid Filled
- Welded case to socket connection
- Plastic Lens



Part No.	Pressure Range	Price /Ea
0440646	30" Hg-0-30 psi	\$33.90
0440647	30" Hg-0 (Vac)	33.90
0440648	0-15 psi	33.90
0440649	0-30 psi	33.90
0440650	0-60 psi	33.90
0440651	0-100 psi	33.90
0440652	0-160 psi	33.90
0440653	0-200 psi	33.90
0440654	0-300 psi	33.90
0440655	0-400 psi	33.90
0440656	0-600 psi	33.90
0440657	0-1000 psi	33.90
0440658	0-1500 psi	33.90
0440659	0-2000 psi	33.90
0440660	0-3000 psi	33.90
0440661	0-5000 psi	33.90
0440662	0-6000 psi	33.90
0440663	0-10000 psi	33.90
0440664	0-15000 psi	33.90

LIQUID FILLED GAUGES & THERMOMETERS

Liquid Filled Gauges Cont.



2.5" Dial All Stainless Gauge - Liquid Filled - 1/4" Center Back Mount

- 316L Stainless Steel Internals and Connection
- Stainless Steel Case - Liquid Filled
- Welded case to socket connection
- Plastic Lens



Part No.	Pressure Range	Price /Ea
0440665	30"Hg-0-30 psi	\$33.90
0440666	30"Hg-0-(Vac)	33.90
0440667	0-15 psi	33.90
0440668	0-30 psi	33.90
0440669	0-60 psi	33.90
0440670	0-100 psi	33.90
0440671	0-160 psi	33.90
0440672	0-200 psi	33.90
0440673	0-300 psi	33.90
0440674	0-400 psi	33.90
0440675	0-600 psi	33.90
0440676	0-1000 psi	33.90
0440677	0-1500 psi	33.90
0440678	0-2000 psi	33.90
0440679	0-3000 psi	33.90
0440680	0-5000 psi	33.90
0440681	0-6000 psi	33.90
0440682	0-10000 psi	33.90
0440683	0-15000 psi	33.90

Liquid Fillable Gauges

4" Dial All Stainless Gauge - 0.5% Accuracy - 1/4" Lower Mount

- Stainless Steel Case - Dry (Field Liquid Fillable)
- 316L Stainless Steel Internals and Connection
- 1/4" NPT Lower Mount
- Welded case to socket connection
- Safety Glass Lens
- Built in Overload and Underload Stops



Part No.	Pressure Range	Price /Ea
0440762	30"Hg-0-30 psi	\$65.00
0440763	30"Hg-0-(Vac)	65.00
0440764	0-15 psi	65.00
0440765	0-30 psi	65.00
0440766	0-60 psi	65.00
0440767	0-100 psi	65.00
0440768	0-160 psi	65.00
0440769	0-200 psi	65.00
0440770	0-300 psi	65.00
0440771	0-400 psi	65.00
0440772	0-600 psi	65.00
0440773	0-1000 psi	65.00
0440774	0-1500 psi	65.00
0440775	0-2000 psi	65.00
0440776	0-3000 psi	65.00
0440777	0-5000 psi	65.00
0440778	0-6000 psi	65.00
0440779	0-10000 psi	65.00
0440780	0-15000 psi	71.50
0440781	0-20000 psi	71.50

4" Dial All Stainless Gauge - 0.5% Accuracy - 1/2" Lower Mount

- Stainless Steel Case - Dry (Field Liquid Fillable)
- 316L Stainless Steel Internals and Connection
- 1/2" NPT Lower Mount
- Welded case to socket connection
- Safety Glass Lens
- Built in Overload and Underload Stops



Part No.	Pressure Range	Price /Ea
0440782	30"Hg-0-30 psi	\$65.00
0440783	30"Hg-0-(Vac)	65.00
0440784	0-15 psi	65.00
0440785	0-30 psi	65.00
0440786	0-60 psi	65.00
0440787	0-100 psi	65.00
0440788	0-160 psi	65.00
0440789	0-200 psi	65.00
0440790	0-300 psi	65.00
0440791	0-400 psi	65.00
0440792	0-600 psi	65.00
0440793	0-1000 psi	65.00
0440794	0-1500 psi	65.00
0440795	0-2000 psi	65.00
0440796	0-3000 psi	65.00
0440797	0-5000 psi	65.00
0440798	0-6000 psi	65.00
0440799	0-10000 psi	65.00
0440800	0-15000 psi	68.00
0440801	0-20000 psi	68.00

4.5" Dial Process Gauge - 0.5% Accuracy - 1/4" Lower Mount

- Phenolic safety case (solid front, blow-out back)
- Dry - (Field liquid fillable, no kit required)
- 316L Stainless Steel Internals and Connection
- 1/4" Lower Mount
- Polycarbonate Lens
- Built in overload and underload stops



Part No.	Pressure Range	Price /Ea
0440722	30"Hg-0-30 psi	\$69.00
0440723	30"Hg-0-(Vac)	69.00
0440724	0-15 psi	69.00
0440725	0-30 psi	69.00
0440726	0-60 psi	69.00
0440727	0-100 psi	69.00
0440728	0-160 psi	69.00
0440729	0-200 psi	69.00
0440730	0-300 psi	69.00
0440731	0-400 psi	69.00
0440732	0-600 psi	69.00
0440733	0-1000 psi	69.00
0440734	0-1500 psi	69.00
0440735	0-2000 psi	69.00
0440736	0-3000 psi	69.00
0440737	0-5000 psi	69.00
0440738	0-6000 psi	69.00
0440739	0-10000 psi	69.00
0440740	0-15000 psi	73.50
0440741	0-20000 psi	73.50

4.5" Dial Process Gauge - 0.5% Accuracy - 1/2" Lower Mount

- Phenolic safety case (solid front, blow-out back)
- Dry - (Field liquid fillable, no kit required)
- 316L Stainless Steel Internals and Connection
- 1/2" Lower Mount
- Polycarbonate Lens
- Built in overload and underload stops



Part No.	Pressure Range	Price /Ea
0440742	30"Hg-0-30 psi	\$69.00
0440743	30"Hg-0-(Vac)	69.00
0440744	0-15 psi	69.00
0440745	0-30 psi	69.00
0440746	0-60 psi	69.00
0440747	0-100 psi	69.00
0440748	0-160 psi	69.00
0440749	0-200 psi	69.00
0440750	0-300 psi	69.00
0440751	0-400 psi	69.00
0440752	0-600 psi	69.00
0440753	0-1000 psi	69.00
0440754	0-1500 psi	69.00
0440755	0-2000 psi	69.00
0440756	0-3000 psi	69.00
0440757	0-5000 psi	69.00
0440758	0-6000 psi	69.00
0440759	0-10000 psi	69.00
0440760	0-15000 psi	73.50
0440761	0-20000 psi	73.50

Thermometers



3" Dial Bimetal Thermometer

- Stainless Steel construction
- 1/2" NPT Rigid Stem Center Back Mount
- +/- 1% full scale accuracy
- Weatherproof/Hermetically Sealed
- Reset at rear of case
- Anti-Vibration Movement
- Stem welded to socket
- Dual Fahrenheit and Celsius scale



Part No.	Stem Length	Price /Ea
-40°F to 120°F / -40°C to 49°C		
0440802	2.5"	\$29.75
0440805	4"	29.75
0440808	6"	29.75
0440811	9"	34.75
0440814	12"	34.75
0°F to 250° / -18°C to 121°C		
0440803	2.5"	\$29.75
0440806	4"	29.75
0440809	6"	29.75
0440812	9"	34.75
0440815	12"	34.75
50°F to 550°F / 10°C to 288°C		
0440804	2.5"	\$29.75
0440807	4"	29.75
0440810	6"	29.75
0440813	9"	34.75
0440816	12"	34.75

THERMOMETERS, HIGH PRESSURE STEEL PIPE FITTINGS

Thermometers Cont.



5" Dial Adjustable Angle Bimetal Thermometer

- Stainless Steel construction
- 1/2" NPT Adjustable Angle
- +/- 1% full scale accuracy
- Weatherproof/Hermetically Sealed
- Reset at rear of case
- Anti-Vibration Movement
- Stem welded to socket



Part No.	Stem Length	Price /Ea
-40°F to 120°F / -40°C to 49°C		
0440832	2.5"	\$85.00
0440835	4"	85.00
0440838	6"	85.00
0440841	9"	90.00
0440844	12"	90.00
0°F to 250°F / -18°C to 121°C		
0440833	2.5"	85.00
0440836	4"	85.00
0440839	6"	85.00
0440842	9"	90.00
0440845	12"	90.00
50°F to 550°F / 10°C to 288°C		
0440834	2.5"	85.00
0440837	4"	85.00
0440840	6"	85.00
0440843	9"	90.00
0440846	12"	90.00

High Pressure Steel Pipe Fittings



Pipe thread is always measured by outside diameter (OD) less 1/4". All pipe, no matter what material and pressure or schedule rating, has the same outside diameter. The wall thickness and the process used in making the pipe will determine the amount of pressure a pipe can carry.

Merchant Steel Plugs

3/4" Taper

Dry seal



Part No.	Size	T.P.I.	Key Size	Pkg. Qty.	Wt./100	Price /Pkg.
24131	1/16	27	5/32	100	.50	\$11.25
24132	1/8	27	3/16	100	.80	12.27
24133	1/4	18	1/4	100	2.00	13.45
24134	3/8	18	5/16	100	4.00	15.27
24135	1/2	14	3/8	50	5.80	12.86
24136	3/4	14	9/16	50	10.20	18.75
24137	1	11-1/2	5/8	25	21.20	20.92
24138	1-1/4	11-1/2	3/4	25	38.00	47.00

7/8" Taper

Flush seal

Size	T.P.I.	Key Size	Pkg. Qty.	Wt./100	Part No.	Price /Pkg.
1/16	27	5/32	100	.50	24139	\$15.27
1/8	27	3/16	100	.80	24142	15.63
1/4	18	1/4	100	2.00	24143	17.45
3/8	18	5/16	100	4.00	24144	21.25
1/2	14	3/8	50	5.80	24145	17.95
3/4	14	9/16	50	10.20	24146	34.54
1	11-1/2	5/8	25	21.20	24147	49.75
1-1/4	11-1/2	3/4	25	38.00	24148	213.00

Holo-Krome Socket Pipe Plugs

- 3/4 taper
- Dry seal
- Heat treated alloy steel



Size	T.P.I.	Key Size	Small Pack			Standard Pack		
			Part No.	Pkg. Qty.	Price /Pkg.	Part No.	Pkg. Qty.	Price /Pkg.
1/16	27	5/32				81131	100	\$26.25
1/8	27	3/16	1181132	5	1.75	81132	100	29.50
1/4	18	1/4	1181133	5	2.45	81133	100	42.35
3/8	18	5/16	1181134	3	2.31	81134	100	67.30
1/2	14	3/8	1181135	2	2.78	81135	50	61.00
3/4	14	9/16	1181136	1	2.49	81136	50	115.00
1	11-1/2	5/8				81137	25	185.50
1-1/4	11-1/2	3/4				81138	25	436.00

7/8" Taper, Heat Treated Alloy Steel

- 7/8 taper
- Flush seal
- Heat treated alloy steel



Size	T.P.I.	Key Size	Small Pack			Standard Pack		
			Part No.	Pkg. Qty.	Price /Pkg.	Part No.	Pkg. Qty.	Price /Pkg.
1/16	27	5/32	1181141	5	\$1.75	81141	100	\$29.20
1/8	27	3/16	1181142	5	1.95	81142	100	32.40
1/4	18	1/4	1181143	3	1.65	81143	100	46.30
3/8	18	5/16	1181144	2	1.58	81144	100	71.50
1/2	14	3/8	1181145	2	2.98	81145	50	64.50
3/4	14	9/16				81146	50	122.00

Pipe Plugs

Metric-DIN 906-Plain



Size	Part No.	Pkg. Qty.	Price /100
M10-1.0	40124	100	\$0.90
M12-1.5	40125	100	1.51
M14-1.5	40126	100	1.99
M16-1.5	40127	100	2.11
M20-1.5	40128	100	2.55
M18-1.5	40129	100	3.01
M22-1.5	40130	50	3.45
M24-1.5	38843	50	3.94
M26-1.5	40132	50	4.27
M30-1.5	40133	25	6.15

EATON | Weatherhead

Seal Nut for Male Pipe Thread



MPT	Vendor No.	Part No.	Price /Each
1/8	C3059X2	424100-131280	\$3.30
1/4	C3059X4	424101-131280	4.24
3/8	C3059X6	424102-131280	4.69
1/2	C3059X8	424103-131280	6.07
3/4	C3059X12	424104-131280	8.18
1	C3059X16	424105-131280	11.16

Hex Socket Plug



MPT	Vendor No.	Weatherhead		Utility	
		Part No.	Price /Each	Part No.	Price /Each
1/16	C3169X1	424106-131280	\$1.02	421359	\$0.31
1/8	C3169X2	424107-131280	1.31	421360	0.19
1/4	C3169X4	424108-131280	1.91	421361	0.21

High Pressure Pipe Fittings

HIGH PRESSURE STEEL PIPE FITTINGS

High Pressure Steel Pipe Fittings Cont.

EATON | Weatherhead

Straight Thread O-Ring Hex Socket Plug



Port	Vendor No.	Part No.	Price /Each
1/8	7238X2	420176-131280	\$1.37
3/16	7238X3	420177-131280	1.33
1/4	7238X4	420178-131280	1.10
3/8	7238X6	420181-131280	1.49
1/2	7238X8	420182-131280	2.02
5/8	7238X10	420183-131280	1.91
3/4	7238X12	420184-131280	3.81
1	7238X16	420186-131280	5.58
1-1/4	7238X20	420187-131280	5.79

Square Head Plug

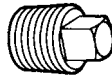

MPT	Vendor No.	Weatherhead		Utility	
		Part No.	Price /Each	Part No.	Price /Each
1/8	C3179X2	424109-131280	\$1.56	421362	\$0.98
1/4	C3179X4	424110-131280	1.62	421363	1.09
3/8	C3179X6	424111-131280	2.10	421364	1.45
1/2	C3179X8	424112-131280	2.98	421365	2.02
3/4	C3179X12	424113-131280	4.15	421366	2.68
1	C3179X16	424114-131280	12.44		

Hex Head Plug

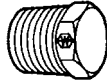

MPT	Vendor No.	Weatherhead		Utility	
		Part No.	Price /Each	Part No.	Price /Each
1/8	C3159X2	424115-131280	\$0.70	421368	\$0.54
1/4	C3159X4	424116-131280	0.82	421369	0.66
3/8	C3159X6	424117-131280	0.94	421370	0.81
1/2	C3159X8	424118-131280	1.78	421371	1.19
3/4	C3159X12	424119-131280	2.80	421372	2.66
1	C3159X16	424120-131280	5.44	421373	4.12
1-1/4	C3159X20	424121-131280	8.78	421374	6.27
1-1/2	C3159X24	424122-131280	16.92	421375	10.98
2	C3159X32	424123-131280	31.04	421376	21.69

Straight Thread O-Ring Hex Head Plug

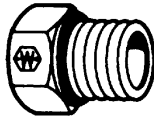

Port	Vendor No.	Part No.	Price /Each
1/4	7237X4*	420190-131280	\$1.06
3/8	7237X6*	420192-131280	1.40
1/2	7237X8*	420193-131280	1.46
5/8	7237X10*	420194-131280	2.31
3/4	7237X12*	420195-131280	4.35
7/8	7237X14*	420196-131280	5.46
1	7237X16	420197-131280	5.52
1-1/4	7237X20	420198-131280	11.82

*Not counterbored.

Note: Parts furnished with zinc plate.

Bushing

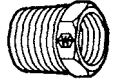

MPT	FPT	Vendor No.	Weatherhead		Utility	
			Part No.	Price /Each	Part No.	Price /Each
1/4	1/8	C3109X4X2	424124-131280	\$1.17	421377	\$0.67
3/8	1/8	C3109X6X2	424125-131280	1.11	421378	0.77
3/8	1/4	C3109X6X4	424126-131280	1.50	421379	0.88
1/2	1/8	C3109X8X2	424127-131280	6.46	421380	3.30
1/2	1/4	C3109X8X4	424128-131280	2.60	421381	1.45
1/2	3/8	C3109X8X6	424129-131280	2.43	421382	1.40
3/4	1/4	C3109X12X4	424130-131280	3.69	421383	2.24
3/4	3/8	C3109X12X6	424131-131280	3.70	421384	2.24
3/4	1/2	C3109X12X8	424132-131280	3.32	421385	1.86
1	3/8	C3109X16X6	424133-131280	6.74	421386	4.23
1	1/2	C3109X16X8	424134-131280	5.84	421387	3.59
1	3/4	C3109X16X12	424135-131280	5.35	421388	3.30
1-1/4	1/2	C3109X20X8	424136-131280	12.81	421389	8.84
1-1/4	3/4	C3109X20X12	424137-131280	11.00	421390	6.94
1-1/4	1	C3109X20X16	424138-131280	10.59	421391	7.02
1-1/2	3/4	C3109X24X12	424139-131280	19.36	421392	12.36
1-1/2	1	C3109X24X16	424140-131280	17.56	421393	12.11
1-1/2	1-1/4	C3109X24X20	424141-131280	19.38	421394	12.79
2	1-1/4	C3109X32X20	424142-131280	32.20	421395	23.03
2	1-1/2	C3109X32X24	424143-131280	32.17	421396	22.49

Straight Thread O-Ring to Female Pipe Adapter



Port	FPT	Vendor No.	Weatherhead		Utility	
			Part No.	Price /Each	Part No.	Price /Each
1/4	1/8	C3269X4X2	424144-131280	\$2.07	421397	\$1.19
1/4	1/4	C3269X4X4	424145-131280	3.65	421398	3.23
5/16	1/8	C3269X5X2	424146-131280	3.11	421399	2.21
3/8	1/4	C3269X6X4	424147-131280	2.63	421400	1.81
3/8	3/8	C3269X6X6	424148-131280	5.29	421401	2.23
3/8	1/2	C3269X6X8	424149-131280	11.07	421402	8.06
1/2	1/4	C3269X8X4	424150-131280	4.42	421403	3.04
1/2	3/8	C3269X8X6	424151-131280	3.30	421404	2.12
1/2	1/2	C3269X8X8	424152-131280	4.63	421405	2.68
5/8	1/4	C3269X10X4	424153-131280	4.75	421406	2.95
5/8	3/8	C3269X10X6	424154-131280	4.60	421407	3.37
5/8	1/2	C3269X10X8	424155-131280	3.97	421408	2.48
5/8	3/4	C3269X10X12	424156-131280	8.08	421409	5.99
3/4	1/2	C3269X12X8	424157-131280	5.79	421410	3.87
3/4	3/4	C3269X12X12	424158-131280	5.93	421411	3.76
7/8	3/4	C3269X14X12	424159-131280	10.63	421412	7.47
1	1/2	C3269X16X8	424160-131280	11.60	421413	6.44
1	3/4	C3269X16X12	424161-131280	8.21	421414	5.49
1	1	C3269X16X16	424162-131280	11.11	421415	7.66
1-1/4	1	C3269X20X16	424163-131280	15.37	421416	11.23
1-1/4	1-1/4	C3269X20X20	424164-131280	18.65		
1-1/2	1-1/2	C3269X24X24	424165-131280	95.02		
2	2	C3269X32X32	424166-131280	138.89		

Adapter

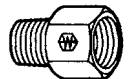

MPT	FPT	Vendor No.	Weatherhead		Utility	
			Part No.	Price /Each	Part No.	Price /Each
1/4	1/8	C3209X4X2	424167-131280	\$2.75	421420	\$2.31
3/8	1/4	C3209X6X4	424168-131280	3.51	421421	2.43
1/2	1/8	C3209X8X2	424169-131280	13.34	421422	7.45
1/2	1/4	C3209X8X4	424170-131280	6.23	421423	4.47
1/2	3/8	C3209X8X6	424171-131280	5.84	421424	3.61
3/4	1/4	C3209X12X4	424172-131280	16.46	421425	11.33
3/4	1/2	C3209X12X8	424173-131280	7.85	421426	5.46
1	1/2	C3209X16X8	424174-131280	19.74	421427	14.35
1	3/4	C3209X16X12	424175-131280	14.99	421428	10.51
1-1/4	1	C3209X20X16	424176-131280	61.41	421429	30.90
1-1/2	1-1/4	C3209X24X20	424177-131280	131.60		
2	1-1/2	C3209X32X24	424178-131280	101.13		

High Pressure Steel Pipe Fittings Cont.



Male Straight Thread O-Ring to Male Pipe Adapter

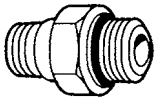

High Pressure
Pipe Fittings

Female Straight Thread O-Ring to Male Pipe Adapter

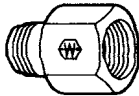

Female Port x MPT	Vendor No.	Weatherhead		Utility	
		Part No.	Price /Each	Part No.	Price /Each
3/8 x3/8	C3239X6X6	424179-131280	\$3.69	421432	\$3.29
3/8 x1/2	C3239X6X8	424180-131280	4.75	421433	9.89
1/2 x3/8	C3239X8X6	424181-131280	4.85	421434	3.61
1/2 x1/2	C3239X8X8	424182-131280	5.71	421435	5.65
5/8 x1/2	C3239X10X8	424183-131280	6.92	421436	4.04

Port	MPT	Vendor No.	Weatherhead		Utility	
			Part No.	Price /Each	Part No.	Price /Each
1/4	1/8	C3249X4X2	424215-131280	\$3.13	421468	\$2.06
3/8	1/4	C3249X6X4	424216-131280	2.04	421469	1.24
1/2	3/8	C3249X8X6	424217-131280	3.22	421470	2.10
1/2	1/2	C3249X8X8	424218-131280	8.35	421471	3.09
5/8	1/2	C3249X10X8	424219-131280	4.94	421472	3.55
3/4	3/4	C3249X12X12	424220-131280	6.00	421473	4.29
1	1	C3249X16X16	424221-131280	10.23	421474	7.12
1-1/4	1-1/4	C3249X20X20	424222-131280	14.26	421475	9.94
1-1/2	1-1/2	C3249X24X24	424223-131280	62.89	421476	39.14

Hex Nipple

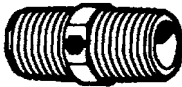

MPT	Vendor No.	Weatherhead		Utility	
		Part No.	Price /Each	Part No.	Price /Each
1/8 x1/8	C3069X2	424199-131280	\$1.15	421452	\$0.69
1/4 x1/8	C3069X4X2	424200-131280	1.69	421453	1.08
1/4 x1/4	C3069X4	424201-131280	1.52	421454	0.81
3/8 x1/8	C3069X6X2	424202-131280	3.78	421455	2.71
3/8 x1/4	C3069X6X4	424203-131280	2.04	421456	1.19
3/8 x3/8	C3069X6	424204-131280	2.07	421457	1.24
1/2 x1/4	C3069X8X4	424205-131280	3.49	421458	2.01
1/2 x3/8	C3069X8X6	424206-131280	3.53	421459	1.91
1/2 x1/2	C3069X8	424207-131280	2.83	421460	1.68
3/4 x1/2	C3069X12X8	424208-131280	5.45	421461	3.12
3/4 x3/4	C3069X12	424209-131280	4.70	421462	2.79
1 x3/4	C3069X16X12	424210-131280	8.43	421463	5.77
1 x 1	C3069X16	424211-131280	7.66	421464	5.13
1-1/4 x 1-1/4	C3069X20	424212-131280	12.84	421465	9.16
1-1/2 x 1-1/2	C3069X24	424213-131280	29.78	421466	18.54
2 x 2	C3069X32	424214-131280	76.96	421467	42.65

Bulkhead Coupling (F)

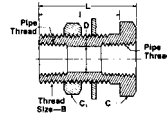
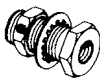

FPT	Vendor No.	Part No.	Price /Each	
			Weatherhead	Utility
1/4	W05465	424225-131280	\$6.41	
1/4	W21204	424226-131280	5.94	
3/8	W17709	424227-131280	14.67	

Bulkhead Coupling (M x F)

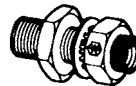

MPT	FPT	Vendor No.	Part No.	Price /Each	
				Weatherhead	Utility
1/2	1/4	W05498	424228-131280	\$10.24	
1/2	1/4	W05499	424229-131280	13.28	

Straight Thread O-Ring Union

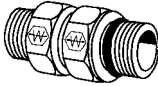

Port	Vendor No.	Part No.	Price /Each	
			Weatherhead	Utility
1/4	C5314x4	423162-131280	\$7.15	
3/8	C5314x6x6	423163-131280	8.81	
1/2	C5314x8x8	423164-131280	11.34	
5/8	C5314x10x10	423165-131280	15.38	
3/4	C5314x12x12	423166-131280	18.64	
1	C5314x16x16	423167-131280	40.88	
1-1/4	C5314x20x20	423168-131280	63.60	
1-1/2	C5314x24x24	423169-131280	76.04	

Coupling

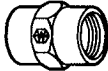

FPT	Vendor No.	Weatherhead		Utility	
		Part No.	Price /Each	Part No.	Price /Each
1/8 x1/8	C3309X2	424184-131280	\$2.14	421437	\$1.34
1/4 x1/8	C3309X4X2	424185-131280	4.42	421438	3.17
1/4 x1/4	C3309X4	424186-131280	2.85	421439	1.60
3/8 x1/4	C3309X6X4	424187-131280	4.16	421440	2.79
3/8 x3/8	C3309X6	424188-131280	3.55	421441	2.24
1/2 x1/4	C3309X8X4	424189-131280	6.16	421442	3.40
1/2 x3/8	C3309X8X6	424190-131280	6.04	421443	3.51
1/2 x1/2	C3309X8	424191-131280	5.18	421444	2.84
3/4 x1/2	C3309X12X8	424192-131280	9.89	421445	6.70
3/4 x3/4	C3309X12	424193-131280	7.48	421446	4.18
1 x3/4	C3309X16X12	424194-131280	19.53	421447	13.91
1 x 1	C3309X16	424195-131280	14.48	421448	8.09
1-1/4 x 1-1/4	C3309X20	424196-131280	24.42	421449	16.74
1-1/2 x 1-1/2	C3309X24	424197-131280	43.87	421450	31.06
2 x 2	C3309X32	424198-131280	124.29	421451	66.52

45° Elbow Female Pipe Forged



FPT	Vendor No.	Weatherhead		Utility	
		Part No.	Price /Each	Part No.	Price /Each
3/8	C3559X6	424232-131280	\$9.39	421485	\$6.55
1/2	C3559X8	424233-131280	15.43	421486	11.65
3/4	C3559X12	424234-131280	25.96	421487	18.03
1	C3559X16	424235-131280	33.61	421488	23.30

45° Elbow Female Pipe Brazed

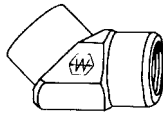

FPT	Vendor No.	Weatherhead		Utility	
		Part No.	Price /Each	Part No.	Price /Each
1/4	TF3559X4	424236-131280	\$7.88	421489	\$5.60

45° Street Elbow Forged



MPT	FPT	Vendor No.	Weatherhead		Utility	
			Part No.	Price /Each	Part No.	Price /Each
1/8	1/8	C3359X2	424237-131280	\$5.94	421490	\$12.35
1/4	1/4	TF3359X4	424238-131280	6.02	421500	3.46
3/8	3/8	C3359X6	424239-131280	7.65	421492	4.28
1/2	1/2	C3359X8	424240-131280	12.55	421493	6.38
3/4	3/4	C3359X12	424241-131280	18.87	421494	8.76
1	1	C3359X16	424242-131280	29.17	421495	16.54

45° Street Elbow Brazed



MPT	FPT	Vendor No.	Weatherhead		Utility	
			Part No.	Price /Each	Part No.	Price /Each
1/8	1/8	TF3359X2	424246-131280	\$6.23	421499	\$4.45
1/4	1/4	TF3359X4	424247-131280	5.12		
3/8	3/8	TF3359X6	424248-131280	6.44	421501	4.54
1/2	1/2	TF3359X8	424249-131280	8.62	421502	6.70
3/4	3/4	TF3359X12	424250-131280	13.78	421503	9.87
1	1	TF3359X16	424251-131280	22.69	421504	16.27
1-1/4	1-1/4	TF3359X20	424252-131280	73.07		
1-1/2	1-1/2	TF3359X24	424253-131280	153.50		

90° Elbow Forged



FPT	Vendor No.	Weatherhead		Utility	
		Part No.	Price /Each	Part No.	Price /Each
1/8	C3509X2	424255-131280	\$5.35	421508	\$2.67
1/4	C3509X4	424256-131280	8.70	421509	2.79
3/8	C3509X6	424257-131280	8.51	421510	3.35
1/2	C3509X8	424258-131280	11.09	421511	5.67
3/4	C3509X12	424259-131280	16.33	421512	9.27
1	C3509X16	424260-131280	27.94	421513	15.81
1-1/4	C3509X20	424261-131280	50.44		
2	C3509X32	424263-131280	307.01		

The : symbol after a price denotes that it is a Direct Ship Product (DSP) and shipping, availability & lead times may vary.

HIGH PRESSURE STEEL PIPE FITTINGS

High Pressure Steel Pipe Fittings Cont.



Weatherhead

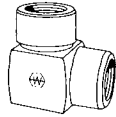

90° Elbow Brazed

Port	Vendor No.	Weatherhead		Utility	
		Part No.	Price /Each	Part No.	Price /Each
1/8 x1/8	TF3509X2	424264-131280	\$2.95	421517	\$2.66
1/4 x1/8	TF3509X4X2	424265-131280	3.89	421518	2.99
1/4 x1/4	TF3509X4	424266-131280	3.63	421519	3.35
3/8 x1/4	TF3509X6X4	424267-131280	8.93	421520	4.54
3/8 x3/8	TF3509X6	424268-131280	7.96	421521	3.82
1/2 x3/8	TF3509X8X6	424269-131280	10.59	421522	8.55
1/2 x1/2	TF3509X8	424270-131280	8.22	421523	6.24
3/4 x1/2	TF3509X12X8	424271-131280	52.02	421524	14.42
3/4 x3/4	TF3509X12	424272-131280	35.93	421525	9.89
1 x1	TF3509X16	424273-131280	44.83	421526	16.11
1-1/4 x 1-1/4	TF3509X20	424274-131280	75.10		
1-1/2 x 1-1/2	TF3509X24	424275-131280	67.60		

90° Street Elbow Forged

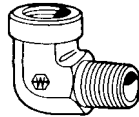

Port	FPT	Vendor No.	Weatherhead		Utility	
			Part No.	Price /Each	Part No.	Price /Each
1/8	1/8	C3409X2	424276-131280	\$3.43	421529	\$2.27
1/4	1/4	C3409X4	424277-131280	5.38	421530	3.04
3/8	3/8	C3409X6	424278-131280	7.26	421531	3.61
1/2	1/2	C3409X8	424279-131280	10.45	421532	5.31
3/4	3/4	C3409X12	424280-131280	17.29	421533	8.50
1	1	C3409X16	424281-131280	27.69	421534	14.68
1-1/4	1-1/4	C3409X20	424282-131280	43.88		

90° Street Elbow Brazed

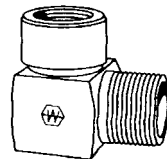

MPT	FPT	Vendor No.	Weatherhead		Utility	
			Part No.	Price /Each	Part No.	Price /Each
1/8	1/8	TF3409X2	424285-131280	\$3.53	421538	\$2.37
1/8	1/4	TF3409X2X4	424286-131280	4.48		
1/4	1/8	TF3409X4X2	424287-131280	4.56	421540	3.05
1/4	1/4	TF3409X4	424288-131280	4.74	421541	2.85
1/4	3/8	TF3409X4X6	424289-131280	5.34	421542	3.61
3/8	1/4	TF3409X6X4	424290-131280	5.36	421543	3.61
3/8	3/8	TF3409X6	424291-131280	5.62	421544	3.49
3/8	1/2	TF3409X6X8	424292-131280	9.68	421545	6.97
1/2	3/8	TF3409X8X6	424293-131280	7.92	421546	5.67
1/2	1/2	TF3409X8	424294-131280	9.05	421547	5.63
1/2	3/4	TF3409X8X12	424295-131280	16.12	421548	11.93
3/4	1/2	TF3409X12X8	424296-131280	14.95	421549	10.72
3/4	3/4	TF3409X12	424297-131280	13.96	421550	8.24
1	1	TF3409X16	424298-131280	21.94	421551	15.19
1-1/4	1-1/4	TF3409X20	424299-131280	43.95	421552	30.39
1-1/2	1-1/2	TF3409X24	424300-131280	79.71	421553	56.34

90° Straight Thread O-Ring Elbow Forged

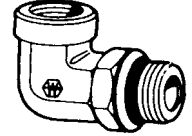

Port	FPT	Vendor No.	Weatherhead		Utility	
			Part No.	Price /Each	Part No.	Price /Each
1/2	3/8	C3459X8	424301-131280	\$10.56	421554	\$6.70
5/8	1/2	C3459X10	424302-131280	19.40	421555	9.22
3/4	3/4	C3459X12	424303-131280	22.67	421556	12.27
1	1	C3459X16	424304-131280	35.08	421557	22.93

90° Straight Thread O-Ring Elbow Brazed

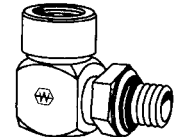

Port	FPT	Vendor No.	Weatherhead		Utility	
			Part No.	Price /Each	Part No.	Price /Each
1/4	1/8				421558	\$3.58
3/8	1/4	TF3459X6	424307-131280	\$10.48	421560	5.26
1/2	3/8	TF3459X8	424308-131280	12.04	421561	7.21
5/8	1/2	TF3459X10	424309-131280	24.73	421562	9.38
3/4	3/4	TF3459X12	424310-131280	40.89	421563	12.62
1	1	TF3459X16	424312-131280	55.45	421565	24.13
1-1/4	1-1/4	TF3459X20	424313-131280	68.58	421566	33.05
1-1/2	1-1/2				421567	63.20
2	2	TF3459X32	424315-131280	262.62	421568	239.85

90° Straight Thread O-Ring Elbow Long - Forged

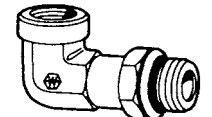

Port	FPT	Vendor No.	Part No.	Price /Each
1/2	3/8	C3469X8	424316-131280	\$30.75
5/8	1/2	C3469X10	424317-131280	35.13
3/4	3/4	C3469X12	424318-131280	57.06
1	1	C3469X16	424319-131280	102.34

90° Straight Thread O-Ring Elbow to Male Pipe Brazed

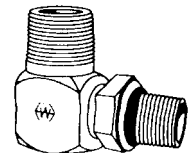

Port	MPT	Weatherhead		Utility	
		Part No.	Price /Each	Part No.	Price /Each
1/4	1/8	424320-131280	\$6.22	421573	\$4.61
3/8	1/4	424322-131280	6.08	421575	4.32
1/2	3/8	424323-131280	8.81	421576	6.96
5/8	1/2	424324-131280	12.03	421577	8.87
3/4	3/4	424325-131280	18.28	421578	13.48
7/8	3/4			421579	27.72
1	1	424327-131280	29.97	421580	22.19

HIGH PRESSURE STEEL PIPE FITTINGS

High Pressure Steel Pipe Fittings Cont.

EATON | Weatherhead

90° Male Elbow Forged



MPT	Vendor No.	Weatherhead		Utility	
		Part No.	Price /Each	Part No.	Price /Each
1/8	C3529X2	424331-131280	\$4.69	421584	\$2.26
1/4	C3529X4	424332-131280	5.51	421585	2.68
3/8	C3529X6	424333-131280	7.13	421586	3.61
1/2	C3529X8	424334-131280	9.16	421587	5.12
3/4	C3529X12	424335-131280	13.88	421588	7.73

90° Male Elbow Brazed

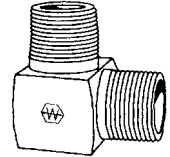

MPT	Vendor No.	Weatherhead		Utility	
		Part No.	Price /Each	Part No.	Price /Each
1/8 x 1/8	TF3529X2	424337-131280	\$3.69	421590	\$2.67
1/4 x 1/4	TF3529X4	424338-131280	4.70	421591	3.13
3/8 x 1/4	TF3529X6X4	424339-131280	5.72	421592	4.11
3/8 x 3/8	TF3529X6	424340-131280	5.92	421593	4.32
1/2 x 3/8	TF3529X8X6	424341-131280	7.34	421594	7.08
1/2 x 1/2	TF3529X8	424342-131280	7.11	421595	5.75
3/4 x 1/2	TF3529X12X8	424343-131280	12.45	421596	9.32
3/4 x 3/4	TF3529X12	424344-131280	12.46	421597	9.16
1 x 3/4	TF3529X16X12	424345-131280	20.12	421598	14.98
1 x 1	TF3529X16	424346-131280	19.76	421599	14.70
1-1/4 x 1-1/4	TF3529X20	424347-131280	38.05		
1-1/2 x 1-1/2	TF3529X24	424348-131280	55.55		

High Pressure Pipe Fittings

Tee Forged

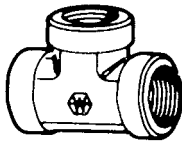

FPT	Vendor No.	Weatherhead		Utility	
		Part No.	Price /Each	Part No.	Price /Each
1/8	C3709X2	424439-131280	\$6.58	421602	\$3.72
1/4	C3709X4	424440-131280	7.41	421603	4.85
3/8	C3709X6	424441-131280	10.80	421604	8.94
1/2	C3709X8	424442-131280	13.60	421605	12.99
3/4	C3709X12	424443-131280	21.75	421606	15.78
1	C3709X16	424444-131280	35.10	421607	3.35
1-1/4	C3709X20	424445-131280	63.55		

Tee Brazed

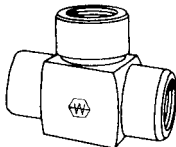

FPT	Vendor No.	Weatherhead		Utility	
		Part No.	Price /Each	Part No.	Price /Each
1/8	TF3709X2	424446-131280	\$4.73	421609	\$4.46
1/4	TF3709X4	424447-131280	5.08	421610	4.98
3/8	TF3709X6	424448-131280	7.98	421611	7.80
1/2	TF3709X8	424449-131280	10.21	421612	7.94
3/4	TF3709X12	424450-131280	15.29	421613	14.46
1	TF3709X16	424451-131280	26.96	421614	13.91
1-1/4	TF3709X20	424452-131280	48.79		
1-1/2	TF3709X24	424453-131280	96.26		
2	TF3709X32	424454-131280	338.25		

Male Branch Tee Forged

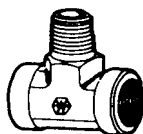

MPT	FPT	Vendor No.	Part No.	Price /Each
1/8	1/8	C3609X2	424455-131280	\$8.50
1/4	1/4	C3609X4	424456-131280	9.26

Male Branch Tee Brazed

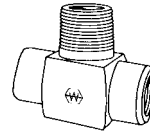

MPT	FPT	Vendor No.	Weatherhead		Utility	
			Part No.	Price /Each	Part No.	Price /Each
1/8	1/8	TF3609X2	424461-131280	\$5.14		
1/4	1/4	TF3609X4	424462-131280	6.09	421625	5.17
3/8	3/8	TF3609X6	424463-131280	12.46	421626	7.06
1/2	1/2	TF3609X8	424464-131280	18.14	421627	9.65
3/4	3/4	TF3609X12	424465-131280	17.97	421628	14.42
1	1	TF3609X16	424466-131280	30.82		

Male Run Tee Forged

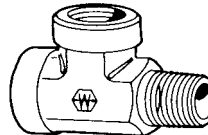

MPT	FPT	Vendor No.	Weatherhead		Utility	
			Part No.	Price /Each	Part No.	Price /Each
1/8	1/8	C3759X2	424469-131280	\$7.69	421632	\$3.09
1/4	1/4	C3759X4	424470-131280	7.97	421633	4.01
3/8	3/8	C3759X6	424471-131280	11.73	421634	5.41
1/2	1/2	C3759X8	424472-131280	15.46	421635	9.98
3/4	3/4	C3759X12	424473-131280	22.77	421636	13.34
1	1	C3759X16	424474-131280	48.26	421637	31.16

Male Run Tee Brazed

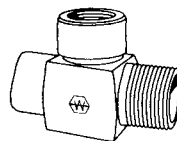

MPT	FPT	Vendor No.	Weatherhead		Utility	
			Part No.	Price /Each	Part No.	Price /Each
1/8	1/8	TF3759X2	424475-131280	\$4.87	421638	\$3.95
1/4	1/4	TF3759X4	424476-131280	6.05	421639	4.66
3/8	3/8	TF3759X6	424477-131280	8.50	421640	5.48
1/2	1/2	TF3759X8	424478-131280	13.44	421641	8.47
3/4	3/4	TF3759X12	424479-131280	20.85	421642	13.47
1	1	TF3759X16	424480-131280	37.30	421643	26.52
1-1/4	1-1/4	TF3759X20	424481-131280	71.47		
1-1/2	1-1/2	TF3759X24	424482-131280	138.92		

Female Run Tee Brazed

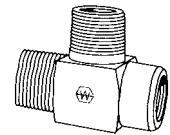

MPT	FPT	Vendor No.	Weatherhead		Utility	
			Part No.	Price /Each	Part No.	Price /Each
1/4	1/4	TF3805X4	424484-131280	\$6.72		
3/8	3/8	TF3805X6	424485-131280	9.63		
1/2	1/2	TF3805X8	424486-131280	15.74		
3/4	3/4	TF3805X12	424487-131280	23.30		
1	1	TF3805X16	424488-131280	38.02		

Cross Forged

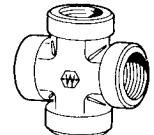

FPT	Vendor No.	Weatherhead		Utility	
		Part No.	Price /Each	Part No.	Price /Each
3/8	C3959X6	424493-131280	\$18.15	421656	\$8.76
1/2	C3959X8	424494-131280	22.42	421657	13.34
3/4	C3959X12	424495-131280	36.57	421658	21.12

Cross Brazed

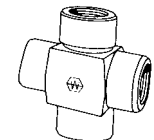

FPT	Vendor No.	Part No.	Price /Each
1/8	TF3959X2	424497-131280	\$10.03
1/4	TF3959X4	424498-131280	11.34
3/8	TF3959X6	424499-131280	13.55
1/2	TF3959X8	424500-131280	18.28
3/4	TF3959X12	424501-131280	26.79
1	TF3959X16	424502-131280	51.20

HIGH PRESSURE STAINLESS STEEL PIPE FITTINGS

High Pressure Stainless Steel Pipe Fittings

High Pressure Pipe Fittings

Female Pipe Coupling

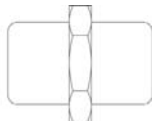

Pipe	Part No.	Price /Each
1/8	426207	\$7.83
1/4 x1/8	426208	10.93
1/4	426209	9.71
3/8 x1/4	426210	13.68
3/8	426211	13.45
1/2 x1/4	426212	24.77
1/2 x3/8	426213	19.82
1/2	426214	34.91
3/4 x1/2	426216	33.75
3/4	426217	33.49
1 x3/4	426218	55.72
1	426219	52.91
1-1/4 x 1	426220	371.46
1-1/4	426221	119.38
1-1/2	426222	208.89
2	426223	326.72

Male Hex Nipple

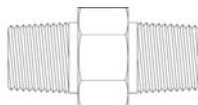

Pipe	Part No.	Price /Each
1/8	426224	\$4.51
1/4 x1/8	426225	7.35
1/4	426226	6.16
3/4 x1/4	426228	9.91
3/8	426229	8.74
1/2 x1/4	426230	15.54
1/2 x3/8	426231	15.49
1/2	426232	13.13
3/4 x1/2	426234	19.18
3/4	426235	22.66
1 x3/4	426238	81.94
1	426239	40.17
1-1/4 x 1	426240	159.87
1-1/4	426241	119.38

Male Pipe Nipple Extended

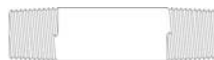

NPTF	Length	Part No.	Price /Each
1/8	1.5	426245	\$9.29
1/8	2	426246	9.59
1/8	2.5	426247	9.01
1/4	1.5	426248	10.98
1/4	2	426249	12.06
1/4	2.5	426250	10.35
1/4	3	426251	14.20
1/4	4	426252	16.61
3/8	2.5	426253	82.16
3/8	3	426254	53.03
3/8	6	426256	115.67
1/2	1.13	426257	9.49
1/2	2.5	426259	16.34
1/2	3	426260	29.27

Pipe Reducer Coupling



MPT	FPT	Part No.	Price /Each
1/8	1/8	426261	\$7.88
1/8	1/4	426262	9.49
1/8	3/8	426263	14.87
1/8	1/2	426264	25.89
1/4	1/8	426265	77.10
1/4	1/4	426266	8.84
1/4	3/8	426267	14.20
1/4	1/2	426268	21.16
1/4	3/4	426269	40.53
3/8	3/8	426270	15.27
3/8	1/2	426271	21.96
3/8	1/2	426272	121.54
1/2	1/2	426273	18.75
1/2	3/4	426274	29.20
1/2	1	426275	103.93
1	1	426278	128.03
1	1-1/4	426279	166.57
1-1/4	1-1/2	426281	202.50

Pipe Reducer Bushing



Pipe	Part No.	Price /Each
1/4 x1/8	426284	\$6.60
3/8 x1/8	426285	7.50
3/8 x1/4	426286	7.72
1/2 x1/8	426287	14.58
1/2 x1/4	426288	10.45
1/2 x3/8	426289	11.52
3/4 x1/4	426290	17.68
3/4 x3/8	426291	18.38
3/4 x1/2	426292	17.84
1 x3/4	426297	26.83
1-1/4 x3/8	426299	123.83
1-1/4 x1/2	426300	98.55
1-1/4 x3/4	426301	88.90
1-1/4 x 1	426302	88.90
1-1/2 x 1	426307	158.52
1-1/2 x 1-1/4	426308	144.62
2 x3/4	426310	252.77
2 x 1	426311	211.05
2 x 1-1/2	426313	211.05

Plug Socket Head



Pipe	Part No.	Price /Each
1/16	426314	\$9.91
1/8	426315	20.54
1/4	426316	15.48
3/8	426317	18.22
1/2	426318	33.21
3/4	426319	48.74
1	426320	56.55
1-1/4	426321	94.80

Plug Hex Head

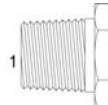

Pipe	Part No.	Price /Each
1/8	426322	\$4.29
1/4	426323	5.19
3/8	426324	7.03
1/2	426325	12.11
3/4	426326	16.88
1	426327	29.46
1-1/4	426328	148.60
1-1/2	426329	160.68

Socket Pipe Plugs Grade 18-8 3/4" Taper



Size	Part No.	T.P.I.	Key Size	Case Qty.	Price /Each
1/16	73389	27	5/32	100	\$1.00
1/8	73390	27	3/16	100	0.92
1/4	73391	18	1/4	100	1.18
3/8	73392	18	5/16	100	2.83
1/2	73393	14	3/8	50	5.36
3/4	73394	14	9/16	50	11.88
1"	73395	11-1/2	5/8	25	19.43
1-1/4	73396	11-1/2	3/4	25	27.29

90° Male Pipe Elbow

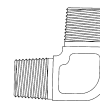

Pipe	Part No.	Price /Each
1/8	426331	\$14.20
1/4 x1/8	426332	30.80
1/4	426333	17.41
3/8 x1/4	426334	81.94
3/8	426335	34.28
1/2	426337	33.75
3/4	426338	127.52
1	426339	146.33

45° Male Pipe Elbow

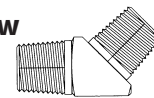

Pipe	Part No.	Price /Each
1/8	426343	\$28.14
1/4	426344	57.84
3/8	426345	58.54
1/2	426346	61.32
3/4	426347	122.74

90° Street Elbow

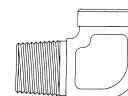

MPT	FPT	Part No.	Price /Each
1/8	1/8	426348	\$17.95
1/4	1/8	426351	46.15
1/4	1/4	426352	22.40
3/8	1/4	426354	72.84
3/8	3/8	426355	29.73
1/2	3/8	426357	75.51
1/2	1/2	426358	40.44
3/4	3/4	426361	100.69
1	1	426362	184.27
1-1/2	1-1/2	426364	500.90

45° Street Elbow

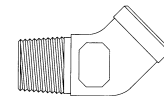

Pipe	Part No.	Price /Each
1/8	426365	\$26.25
1/4	426366	31.34
3/8	426367	85.69
1/2	426368	98.55
3/4	426369	172.53
1	426370	263.44
1-1/4	426371	508.69

HIGH PRESSURE STAINLESS STEEL PIPE FITTINGS

High Pressure Stainless Steel Pipe Fittings Cont.

90° Female Pipe Elbow

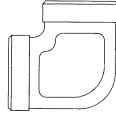

Pipe	Part No.	Price /Each
1/8	426372	\$17.41
1/4 x 1/8	426373	222.79
1/4	426374	21.70
3/8 x 1/4	426375	56.77
3/8	426376	28.93
1/2	426377	38.03
3/4	426378	66.14
1	426379	144.10

45° Female Pipe Elbow



Pipe	Part No.	Price /Each
1/8	426383	\$34.82
1/4	426384	93.70
3/8	426385	79.26
1/2	426386	61.05
3/4	426387	167.76

Male Pipe Tee

Pipe	Part No.	Price /Each
1/4	426389	\$23.57
3/8	426390	47.51
1/2	426391	51.69
3/4	426392	151.42

Female Run Service Tee

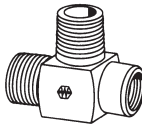

Pipe	Part No.	Price /Each
1/4	426401	\$28.67
3/8	426402	46.13
1/2	426403	64.00

Male Run Pipe Tee



Pipe	Part No.	Price /Each
3/8	426410	\$85.96
1/2	426411	123.19

Male Branch Pipe Tee

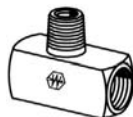

Pipe	Part No.	Price /Each
3/8	426417	\$70.15
1/2	426418	75.51

Female Pipe Tee



Pipe	Part No.	Price /Each
1/8	426422	\$25.45
1/4	426423	28.66
3/8	426424	39.64
1/2	426425	60.21
3/4	426426	99.05
1	426427	159.65

Female Pipe Cross

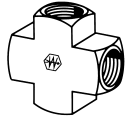

Pipe	Part No.	Price /Each
1/4	426432	\$56.84
3/8	426433	81.94

Steel SAE 37° (JIC) Flare-Twin

EATON | Weatherhead

Male Connector

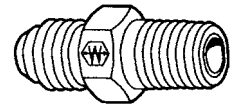

Tube O.D.	MPT	Vendor No.	Weatherhead		Utility	
			Part No.	Price /Each	Part No.	Price /Each
1/8	1/8	C5205X2	423000-131280	\$2.58	420650	\$1.76
3/16	1/8	C5205X3	423001-131280	2.00	420651	1.03
1/4	1/8	C5205X4	423002-131280	1.03	420652	0.57
1/4	1/4	C5205X4X4	423003-131280	1.08	420653	0.78
1/4	3/8	C5205X4X6	423004-131280	2.53	420654	1.40
1/4	1/2	C5205X4X8	423005-131280	4.92	420655	3.40
5/16	1/8	C5205X5	423006-131280	1.47	420656	0.85
5/16	1/4	C5205X5X4	423007-131280	1.65	420657	0.93
5/16	3/8	C5205X5X6	423008-131280	2.59	420658	1.84
3/8	1/8	C5205X6X2	423009-131280	1.39	420659	0.88
3/8	1/4	C5205X6	423010-131280	1.11	420660	0.75
3/8	3/8	C5205X6X6	423011-131280	1.62	420661	1.11
3/8	1/2	C5205X6X8	423012-131280	2.82	420662	1.52
1/2	1/4	C5205X8X4	423013-131280	2.23	420663	1.40
1/2	3/8	C5205X8	423014-131280	1.75	420664	1.14
1/2	1/2	C5205X8X8	423015-131280	2.88	420665	1.54
1/2	3/4	C5205X8X12	423016-131280	4.60	420666	2.89
5/8	3/8	C5205X10X6	423017-131280	3.60	420667	2.18
5/8	1/2	C5205X10	423018-131280	2.58	420668	1.95
5/8	3/4	C5205X10X12	423019-131280	4.02	420669	2.76
3/4	1/2	C5205X12X8	423020-131280	4.31	420670	2.94
3/4	3/4	C5205X12	423021-131280	4.09	420671	2.69
3/4	1	C5205X12X16	423022-131280	6.28	420672	4.53
7/8	3/4	C5205X14	423023-131280	6.59	420673	4.70
1	3/4	C5205X16X12	423024-131280	6.01	420674	4.41
1	1	C5205X16	423025-131280	6.34	420675	3.91
1	1-1/4	C5205X16X20	423026-131280	13.53	420676	9.61
1-1/4	1	C5205X20X16	423027-131280	12.44	420677	9.47
1-1/4	1-1/4	C5205X20	423028-131280	10.43	420678	7.38
1-1/2	1-1/4	C5205X24X20	423029-131280	27.78	420679	18.13
1-1/2	1-1/2	C5205X24	423030-131280	18.29	420680	12.36
2	2	C5205X32	423031-131280	51.17	420681	30.00

High Pressure Pipe & 37° JIC Fittings

STEEL SAE 37° (JIC) FLARE-TWIN

Steel SAE 37° (JIC) Flare-Twin Cont.

EATON | Weatherhead

37° JIC Fittings

3-Piece Sleeve

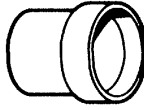

Tube O.D.	Vendor No.	Weatherhead		Utility	
		Part No.	Price /Each	Part No.	Price /Each
1/8	C5165X2	423032-131280	\$0.58		
3/16	C5165X3	423033-131280	0.57	420683	\$0.33
1/4	C5165X4	423034-131280	0.50	420684	0.35
5/16	C5165X5	423035-131280	0.55	420685	0.39
3/8	C5165X6	423036-131280	0.60	420686	0.39
1/2	C5165X8	423037-131280	0.62	420687	0.45
5/8	C5165X10	423038-131280	0.72	420688	0.52
3/4	C5165X12	423039-131280	1.08	420689	0.64
7/8	C5165X14	423040-131280	2.19	420690	1.17
1	C5165X16	423041-131280	1.82	420691	1.09
1-1/4	C5165X20	423042-131280	4.85	420692	2.40
1-1/2	C5165X24	423043-131280	8.02		
2	C5165X32	423044-131280	22.68		

3-Piece Nut

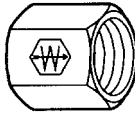

Tube O.D.	Vendor No.	Weatherhead		Utility	
		Part No.	Price /Each	Part No.	Price /Each
1/8	C5105X2	423045-131280	\$0.61		
3/16	C5105X3	423046-131280	0.61	420696	\$0.41
1/4	C5105X4	423047-131280	0.65	420697	0.31
5/16	C5105X5	423048-131280	0.69	420698	0.36
3/8	C5105X6	423049-131280	0.65	420699	0.41
1/2	C5105X8	423050-131280	1.11	420700	0.62
5/8	C5105X10	423051-131280	1.31	420701	0.98
3/4	C5105X12	423052-131280	2.32	420702	1.34
7/8	C5105X14	423053-131280	3.22	420703	2.30
1	C5105X16	423054-131280	3.32	420704	2.22
1-1/4	C5105X20	423055-131280	14.96	420705	4.28
1-1/2	C5105X24	423056-131280	10.18	420706	6.51
2	C5105X32	423057-131280	36.57	420707	22.38

2-Piece Nut Short

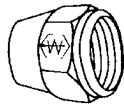

Tube O.D.	Vendor No.	Weatherhead		Utility	
		Part No.	Price /Each	Part No.	Price /Each
1/4	C5125X4	423058-131280	\$1.11	420708	\$0.62
5/16	C5125X5	423059-131280	1.17	420709	1.28
3/8	C5125X6	423060-131280	0.93	420710	0.69
1/2	C5125X8	423061-131280	1.57	420711	1.29
5/8	C5125X10	423062-131280	2.43	420712	3.87
3/4	C5125X12	423063-131280	3.73		

2-Piece Nut Long

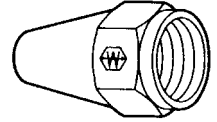

Tube O.D.	Vendor No.	Part No.	Price /Each
1/4	C5115X4	423064-131280	\$0.98
5/16	C5115X5	423065-131280	0.98
3/8	C5115X6	423066-131280	1.05
1/2	C5115X8	423067-131280	1.42
5/8	C5115X10	423068-131280	2.66
3/4	C5115X12	423069-131280	4.77

Bulkhead Nut

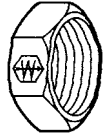

Tube O.D.	Vendor No.	Weatherhead		Utility	
		Part No.	Price /Each	Part No.	Price /Each
1/8				420724	\$2.67
3/16	C5924X3	423075-131280	\$2.82	420725	1.98
1/4	C5924X4	423076-131280	0.86	420726	0.36
5/16	C5924X5	423077-131280	0.94	420727	0.54
3/8	C5924X6	423078-131280	0.86	420728	0.55
1/2	C5924X8	423079-131280	1.05	420729	0.50
5/8	C5924X10	423080-131280	1.03	420730	0.72
3/4	C5924X12	423081-131280	2.10	420731	1.33
7/8	C5924X14	423082-131280	4.51	420732	2.48
1	C5924X16	423083-131280	3.66	420733	2.02
1-1/4	C5924X20	423084-131280	3.75		

Cap

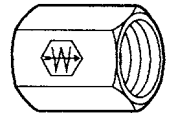

Tube O.D.	Vendor No.	Weatherhead		Utility	
		Part No.	Price /Each	Part No.	Price /Each
1/8	C5129X2	423087-131280	\$2.11	420737	\$1.85
3/16	C5129X3	423088-131280	2.11	420738	1.70
1/4	C5129X4	423089-131280	0.88	420739	0.59
5/16	C5129X5	423090-131280	1.11	420740	0.75
3/8	C5129X6	423091-131280	1.22	420741	0.89
1/2	C5129X8	423092-131280	1.18	420742	1.03
5/8	C5129X10	423093-131280	2.28	420743	1.65
3/4	C5129X12	423094-131280	2.95	420744	2.48
1	C5129X16	423095-131280	5.18	420745	3.76
1-1/4	C5129X20	423096-131280	12.55	420746	8.24
1-1/2	C5129X24	423097-131280	24.89	420747	15.45
2	C5129X32	423098-131280	93.25	420748	37.86

STEEL SAE 37° (JIC) FLARE-TWIN

Steel SAE 37° (JIC) Flare-Twin Cont.



Weatherhead

Plug

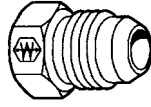

Tube O.D.	Vendor No.	Weatherhead		Utility	
		Part No.	Price /Each	Part No.	Price /Each
1/4	C5229X4	423099-131280	\$0.99	420749	\$0.62
5/16	C5229X5	423100-131280	1.20	420750	0.88
3/8	C5229X6	423101-131280	1.13	420751	0.72
1/2	C5229X8	423102-131280	1.53	420752	1.28
5/8	C5229X10	423103-131280	2.13	420753	1.70
3/4	C5229X12	423104-131280	2.62	420754	2.27
7/8	C5229X14	423105-131280	8.05	420755	5.57
1	C5229X16	423106-131280	4.64	420756	3.30
1-1/4	C5229X20	423107-131280	8.86	420757	6.30
1-1/2	C5229X24	423108-131280	26.30	420758	18.56
2	C5229X32	423109-131280	93.21	420759	39.63

Reducer

Use with 3-Piece Nut

Size A denotes Female Tube O.D.

Size B denotes Male Tube O.D.

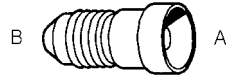

Size A	Size B	Vendor No.	Weatherhead		Utility	
			Part No.	Price /Each	Part No.	Price /Each
3/8	1/4	C5015X6X4	423110-131280	\$2.59	420760	\$1.66
1/2	1/4	C5015X8X4	423111-131280	4.77	420761	3.04
1/2	3/8	C5015X8X6	423112-131280	3.16	420762	2.03
5/8	1/4*	C5015X10X4	423113-131280	7.09	420763	5.18
5/8	3/8*	C5015X10X6	423114-131280	5.18		
5/8	1/2*	C5015X10X8	423115-131280	3.18	420765	2.73
3/4	1/4	C5015X12X4	423116-131280	9.54	420766	5.93
3/4	3/8	C5015X12X6	423117-131280	8.43	420767	5.71
3/4	1/2	C5015X12X8	423118-131280	5.64	420768	4.10
3/4	5/8*	C5015X12X10	423119-131280	6.14	420769	4.28
7/8	1/2*	C5015X14X8	423121-131280	15.70		
7/8	3/4*	C5015X14X12	423123-131280	13.89		
1	1/2*	C5015X16X8	423124-131280	14.65	420774	10.26
1	5/8*	C5015X16X10	423125-131280	13.14	420775	9.90
1	3/4	C5015X16X12	423126-131280	10.62	420776	8.13
1	7/8*				420777	12.00
1-1/4	3/4	C5015X20X12	423128-131280	20.46	420778	16.80
1-1/4	1*	C5015X20X16	423129-131280	22.20	420779	15.90
1-1/2	1-1/4*	C5015X24X20	423130-131280	48.25	420780	34.28
2	1-1/2*	C5015X32X24	423131-131280	115.75		

*1 piece design - not used with 3-piece nut.

Small Hex Union

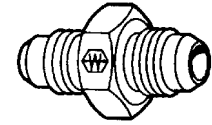

Tube O.D.	Vendor No.	Weatherhead		Utility	
		Part No.	Price /Each	Part No.	Price /Each
1/8 x1/8	C5305X2	423132-131280	\$10.97	420782	\$8.28
3/16 x3/16	C5305X3	423133-131280	5.87	420783	4.51
1/4 x1/4	C5305X4	423134-131280	1.63	420784	0.97
5/16 x1/4	C5305X5X4	423135-131280	6.95	420785	9.35
5/16 x5/16	C5305X5	423136-131280	2.19	420786	1.45
3/8 x1/4	C5305X6X4	423137-131280	3.44	420787	1.70
3/8 x5/16	C5305X6X5	423138-131280	10.26	420788	7.36
3/8 x3/8	C5305X6	423139-131280	1.63	420789	1.15
1/2 x3/8	C5305X8X6	423140-131280	5.92	420790	2.48
1/2 x1/2	C5305X8	423141-131280	2.70	420791	1.52
5/8 x1/2	C5305X10X8	423142-131280	6.71	420792	2.89
5/8 x5/8	C5305X10	423143-131280	3.00	420793	2.70
3/4 x1/2	C5305X12X8	423144-131280	5.86	420794	5.33
3/4 x5/8	C5305X12X10	423145-131280	8.35	420795	4.17
3/4 x3/4	C5305X12	423146-131280	5.41	420796	3.07
7/8 x7/8	C5305X14	423147-131280	7.47	420797	5.50
1 x3/4	C5305X16X12	423148-131280	10.40	420798	7.21
1 x 1	C5305X16	423149-131280	7.92	420799	3.99
1-1/4 x 1-1/4	C5305X20	423150-131280	14.83	420800	7.11
1-1/2 x 1-1/2	C5305X24	423151-131280	30.00	420801	16.38
2 x 2	C5305X32	423152-131280	76.07	420802	52.92

Large Hex Union

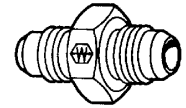

Tube O.D.	Vendor No.	Part No.	Price /Each
1/4	C5306x4	423153-131280	\$2.88
5/16	C5306x5	423154-131280	10.17
3/8	C5306x6	423155-131280	2.05
1/2	C5306x8	423156-131280	3.67
5/8	C5306x10	423157-131280	5.24
3/4	C5306x12	423158-131280	7.48
1	C5306x16	423159-131280	11.63
1-1/4	C5306x20	423160-131280	36.56

37° JIC Fittings

STEEL SAE 37° (JIC) FLARE-TWIN

Steel SAE 37° (JIC) Flare-Twin Cont.

EATON | Weatherhead
Bulkhead Union

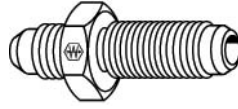

Tube O.D.	Vendor No.	Weatherhead		Utility	
		Part No.	Price /Each	Part No.	Price /Each
3/16	C5325x3	423171-131280	\$19.60	420821	\$19.45
1/4	C5325x4	423172-131280	4.40	420822	2.43
5/16	C5325x5	423173-131280	4.79	420823	3.34
3/8	C5325x6	423174-131280	3.56	420824	2.66
1/2	C5325x8	423175-131280	5.46	420825	3.20
5/8	C5325x10	423176-131280	7.09	420826	5.40
3/4	C5325x12	423177-131280	12.45	420827	6.49
1	C5325x16	423178-131280	18.30	420828	10.85
1-1/4	C5325x20	423179-131280	34.77		

Straight Thread O-Ring Connector

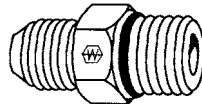

Tube O.D.	Port	Vendor No.	Weatherhead		Utility	
			Part No.	Price /Each	Part No.	Price /Each
1/8	1/8	C5315X2	424000-131280	\$8.07		
3/16	3/16	C5315X3	424001-131280	8.94		
1/4	1/4	C5315X4	424002-131280	1.24	421313	0.89
1/4	5/16	C5315X4X5	424003-131280	4.34	421314	3.34
1/4	3/8	C5315X4X6	424004-131280	2.82	421315	1.61
1/4	1/2	C5315X4X8	424005-131280	4.32	421316	3.04
5/16	1/4	C5315X5X4	424006-131280	5.13		
5/16	5/16	C5315X5	424007-131280	1.99		
5/16	3/8	C5315X5X6	424008-131280	2.63		
3/8	1/4	C5315X6X4	424009-131280	2.46		
3/8	5/16	C5315X6X5	424010-131280	3.07		
3/8	3/8	C5315X6	424011-131280	1.64	421322	1.40
3/8	1/2	C5315X6X8	424012-131280	2.87	421323	1.56
3/8	5/8	C5315X6X10	424013-131280	3.71	421324	2.56
1/2	3/8	C5315X8X6	424014-131280	3.50	421325	2.10
1/2	1/2	C5315X8X8	424015-131280	2.75	421326	1.64
1/2	5/8	C5315X8X10	424016-131280	3.35	421327	2.40
1/2	3/4	C5315X8X12	424017-131280	5.39	421328	3.61
5/8	1/2	C5315X10X8	424018-131280	3.84	421329	2.57
5/8	5/8	C5315X10	424019-131280	3.70	421330	2.57
5/8	3/4	C5315X10X12	424020-131280	5.78	421331	3.90
5/8	1	C5315X10X16	424021-131280	13.53	421332	7.48
3/4	1/2	C5315X12X8	424022-131280	5.56		
3/4	5/8	C5315X12X10	424023-131280	5.42	421334	3.77
3/4	3/4	C5315X12	424024-131280	5.26	421335	3.46
3/4	7/8	C5315X12X14	424025-131280	8.05		
3/4	1	C5315X12X16	424026-131280	7.97	421337	5.58
3/4	1-1/4	C5315X12X20	424027-131280	20.09		
7/8	7/8	C5315X14	424028-131280	7.05		
1	5/8	C5315X16X10	424029-131280	13.50		
1	3/4	C5315X16X12	424030-131280	7.36	421341	5.30
1	1	C5315X16	424031-131280	8.04	421342	4.83
1	1-1/4	C5315X16X20	424032-131280	15.00		
1-1/4	1	C5315X20X16	424033-131280	16.81	421344	4.69
1-1/4	1-1/4	C5315X20	424034-131280	15.53	421345	11.58
1-1/4	1-1/2	C5315X20X24	424035-131280	34.38		
1-1/2	1-1/4	C5315X24X20	424036-131280	29.24		
1-1/2	1-1/2	C5315X24	424037-131280	20.69		
1-1/2	2	C5315X24X32	424038-131280	110.25		

Female Connector

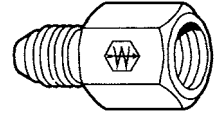

Tube O.D.	FPT	Vendor No.	Weatherhead		Utility	
			Part No.	Price /Each	Part No.	Price /Each
1/8	1/8	C5255X2	423180-131280	\$9.12	420830	\$5.54
3/16	1/8	C5255X3	423181-131280	4.99	420831	6.55
1/4	1/8	C5255X4	423182-131280	1.63	420832	0.77
1/4	1/4	C5255X4X4	423183-131280	3.40	420833	1.28
5/16	1/8	C5255X5	423184-131280	2.65		
5/16	1/4	C5255X5X4	423185-131280	2.55	420835	2.15
3/8	1/4	C5255X6	423186-131280	1.99	420836	1.03
3/8	3/8	C5255X6X6	423187-131280	3.38	420837	1.93
1/2	3/8	C5255X8	423188-131280	2.49	420838	1.63
1/2	1/2	C5255X8X8	423189-131280	4.72	420839	2.72
5/8	3/8	C5255X10X6	423190-131280	6.41	420840	4.07
5/8	1/2	C5255X10	423191-131280	4.69	420841	2.56
3/4	1/2	C5255X12X8	423192-131280	9.49	420842	6.44
3/4	3/4	C5255X12	423193-131280	6.37	420843	3.51
7/8	3/4	C5255X14	423194-131280	6.42	420844	6.38
1	1	C5255X16	423195-131280	9.54	420845	5.71
1-1/4	1-1/4	C5255X20	423196-131280	23.40	420846	13.03
1-1/2	1-1/2	C5255X24	423197-131280	51.15		
2	2	C5255X32	423198-131280	94.71		

Adapter

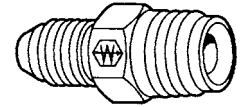

Tube O.D.	Thread	Vendor No.	Part No.	Price /Each
1/4	7/16-24 Inverted	C5880X4	423199-131280	\$4.08
5/16	1/2-20 Inverted	C5880X5	423200-131280	7.16
3/8	5/8-18 Inverted	C5880X6	423201-131280	10.32
1/2	3/4-18 Inverted	C5880X8	423202-131280	16.07

Female Bulkhead Connector

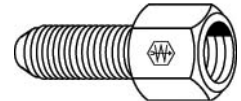

Tube O.D.	FPT	Vendor No.	Part No.	Price /Each
1/4	1/8	C5275X4	423203-131280	\$6.97
3/8	1/4	C5275X6	423204-131280	9.24
1/2	3/8	C5275X8	423205-131280	13.17
5/8	1/2	C5275X10	423206-131280	15.73
3/4	3/4	C5275X12	423207-131280	24.31
1	1	C5275X16	423208-131280	29.24

Straight Thread O-Ring Extended Connector

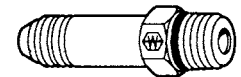

Tube O.D.	Port	Vendor No.	Weatherhead		Utility	
			Part No.	Price /Each	Part No.	Price /Each
1/4	1/4	C5316X4	423209-131280	\$5.14		
3/8	3/8	C5316X6	423210-131280	3.53	420860	3.19
1/2	1/2	C5316X8	423211-131280	6.23	420861	5.09
3/4	3/4	C5316X12	423213-131280	14.29	420863	14.30
1	1	C5316X16	423214-131280	23.43	420864	19.97

STEEL SAE 37° (JIC) FLARE-TWIN

Steel SAE 37° (JIC) Flare-Twin Cont.



Weatherhead

37° Female Swivel to Male O-Ring

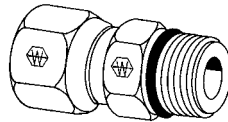

Tube O.D.	Port	Vendor No.	Weatherhead		Utility	
			Part No.	Price /Each	Part No.	Price /Each
1/4	1/4	C5216X4X4	423216-131280	\$8.20	420866	\$6.70
1/4	3/8	C5216X4X6	423217-131280	8.79		
3/8	3/8	C5216X6X6	423218-131280	9.69	420868	6.46
3/8	1/2	C5216X6X8	423219-131280	10.64		
1/2	1/2	C5216X8X8	423220-131280	10.69	420870	7.30
5/8	5/8	C5216X10X10	423221-131280	14.22	420871	8.06
3/4	3/4	C5216X12X12	423222-131280	15.15	420872	9.12
1	1	C5216X16X16	423223-131280	27.43	420873	18.67
1-1/4	1-1/4	C5216X20X20	423224-131280	45.90		

Female 37° JIC Swivel to Female Pipe

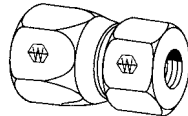

Tube O.D.	FPT	Vendor No.	Weatherhead		Utility	
			Part No.	Price /Each	Part No.	Price /Each
1/4	1/4	C5256X4X4	423227-131280	\$10.99	420877	\$6.39
3/8	3/8	C5256X6X6	423228-131280	11.69	420878	4.79
1/2	1/2	C5256X8X8	423229-131280	11.35	420879	5.00
3/4	3/4	C5256X12	423230-131280	14.06	420880	8.19
1	1	C5256X16	423231-131280	19.85	420881	15.97

45° Male Elbow Brazed

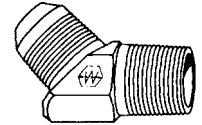

Tube O.D.	MPT	Vendor No.	Weatherhead		Utility	
			Part No.	Price /Each	Part No.	Price /Each
1/8	1/8	TF5355X2	423232-131280	\$13.55		
1/4	1/8	TF5355X4	423233-131280	4.77		
1/4	1/4	TF5355X4X4	423234-131280	4.87	420884	3.15
5/16	1/8	TF5355X5	423235-131280	6.61		
3/8	1/8	TF5355X6X2	423237-131280	5.57		
3/8	1/4	TF5355X6	423238-131280	4.95	420888	3.05
3/8	3/8	TF5355X6X6	423239-131280	6.15	420889	3.96
3/8	1/2	TF5355X6X8	423240-131280	7.18	420890	5.49
1/2	1/4	TF5355X8X4	423241-131280	7.12		
1/2	3/8	TF5355X8	423242-131280	5.74	420892	3.71
1/2	1/2	TF5355X8X8	423243-131280	6.90	420893	4.38
5/8	3/8	F5355X10X6	423244-131280	9.53	420894	6.65
5/8	1/2	TF5355X10	423245-131280	7.70		
5/8	3/4	TF5355X10X12	0447698	8.45		
3/4	1/2	F5355X12X8	423246-131280	10.60		
3/4	3/4	TF5355X12	423247-131280	10.49	420897	5.93
3/4	1	F5355X12X16	423248-131280	16.81	420898	11.47
1	3/4	F5355X16X12	423249-131280	17.55	420899	12.27
1	1	TF5355X16	423250-131280	15.61	420900	9.60
1-1/4	1-1/4	TF5355X20	423251-131280	27.71	420901	20.77
1-1/2	1-1/2	TF5355X24	423252-131280	38.38	420902	33.61
2	2	TF5355X32	423253-131280	115.79	420903	79.51

45° Male Elbow Forged

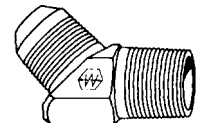

Tube O.D.	MPT	Vendor No.	Weatherhead		Utility	
			Part No.	Price /Each	Part No.	Price /Each
3/16	1/8	C5355X3	423912-131280	\$7.59	421670	\$6.69
1/4	1/8	C5355X4	423913-131280	5.15	421671	3.13
1/4	1/4	C5355X4X4	423914-131280	6.61	421672	3.17
5/16	1/8	C5355X5	423915-131280	6.66	421673	4.75
5/16	1/4	C5355X5X4	423916-131280	7.51	421674	3.43
3/8	1/8	C5355X6X2	423917-131280	7.45	421675	5.22
3/8	1/4	C5355X6	423918-131280	6.46	421676	2.99
3/8	3/8	C5355X6X6	423919-131280	7.85	421677	3.90
3/8	1/2	C5355X6X8	423920-131280	8.50	421678	5.05
1/2	1/4	C5355X8X4	423921-131280	8.45	421679	5.26
1/2	3/8	C5355X8	423922-131280	8.08	421680	3.87
1/2	1/2	C5355X8X8	423923-131280	9.39	421681	4.38
5/8	3/8	C5355X10X6	423924-131280	10.45	421682	7.14
5/8	1/2	C5355X10	423925-131280	9.53	421683	5.05
3/4	1/2	C5355X12X8	423926-131280	15.75	421684	8.04
3/4	3/4	C5355X12	423927-131280	13.31	421685	8.95
1	3/4	C5355X16X12	423928-131280	18.50	421686	12.16
1	1	C5355X16	423929-131280	21.93		
1-1/2	1-1/2	C5355X24	423930-131280	45.84		

37° JIC Fittings

STEEL SAE 37° (JIC) FLARE-TWIN

Steel SAE 37° (JIC) Flare-Twin Cont.

EATON | Weatherhead

37° JIC Fittings

Swivel Nut 45° Elbow Brazed

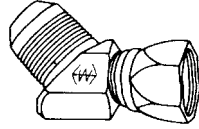

Tube O.D.	Vendor No.	Weatherhead		Utility	
		Part No.	Price /Each	Part No.	Price /Each
1/4	TF5356X4	423254-131280	\$5.82	420904	\$3.59
3/8	TF5356X6	423256-131280	5.75		
1/2	TF5356X8	423257-131280	6.81	420907	4.69
5/8	TF5356X10	423258-131280	10.10		
3/4	TF5356X12	423259-131280	15.29	420909	8.76
1	TF5356X16	423260-131280	23.09	420910	13.39
1-1/4	TF5356X20	423261-131280	35.83	420911	26.78

Swivel Nut 45° Elbow Forged

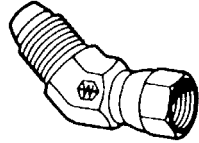

Tube O.D.	Vendor No.	Weatherhead		Utility	
		Part No.	Price /Each	Part No.	Price /Each
1/4	C5356X4	423931-131280	\$6.86	421689	\$3.76
3/8	C5356X6	423932-131280	8.16	421690	3.61
1/2	C5356X8	423933-131280	9.98	421691	4.43
5/8	C5356X10	423934-131280	15.27	421692	6.60
3/4	C5356X12	423935-131280	18.30	421693	8.50
7/8	C5356X14	423936-131280	31.20		
1	C5356X16	423937-131280	26.88	421695	14.01

45° Bulkhead Union Elbow

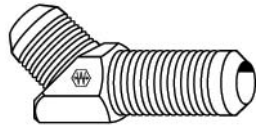

Tube O.D.	Vendor No.	Part No.	Price /Each
1/4	TF5375X4	423264-131280	\$7.57
5/16	TF5375X5	423265-131280	8.43
3/8	TF5375X6	423266-131280	8.65
1/2	TF5375X8	423267-131280	10.96
5/8	TF5375X10	423268-131280	14.25
3/4	TF5375X12	423269-131280	18.29
1	TF5375X16	423270-131280	26.50

Straight Thread O-Ring 45° Elbow Brazed

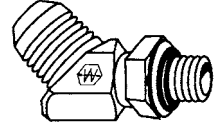

Tube O.D.	Port	Vendor No.	Weatherhead		Utility	
			Part No.	Price /Each	Part No.	Price /Each
1/4	1/4	TF5365X4	423271-131280	\$6.04		
3/8	3/8	TF5365X6	423273-131280	6.96		
3/8	1/2	TF5365X6X8	423274-131280	8.49		
1/2	3/8	TF5365X8X6	423275-131280	10.97	420924	6.96
1/2	1/2	TF5365X8	423276-131280	8.55	420925	5.60
1/2	5/8	TF5365X8X10	423277-131280	10.27		
5/8	5/8	TF5365X10	423279-131280	9.51	420928	6.94
5/8	3/4	TF5365X10X12	0447699	18.57		
3/4	5/8	TF5365X12X10	423280-131280	15.35	420929	10.72
3/4	3/4	TF5365X12	423281-131280	15.23	420930	9.17
3/4	1	TF5365X12X16	423282-131280	24.51		
7/8	7/8	TF5365X14	423283-131280	23.40		
1	1	TF5365X16	423285-131280	22.16		
1-1/4	1-1/4	TF5365X20	423286-131280	36.56		
1-1/2	1-1/2	TF5365X24	423287-131280	59.94		

Straight Thread O-Ring 45° Elbow Forged

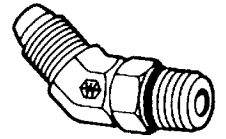

Tube O.D.	Port	Vendor No.	Weatherhead		Utility	
			Part No.	Price /Each	Part No.	Price /Each
1/4	1/4	C5365X4	423699-131280	\$8.31	421698	\$3.92
5/16	5/16	C5365X5	423700-131280	9.50	421699	6.23
3/8	3/8	C5365X6	423701-131280	9.45	421700	4.43
1/2	1/2	C5365X8	423702-131280	10.23	421701	6.11
1/2	5/8	C5365X8X10	423703-131280	19.05	421702	7.63
5/8	5/8	C5365X10	423704-131280	16.83	421703	6.70
3/4	5/8	C5365X10X12	423705-131280	28.15	421704	11.09
3/4	3/4	C5365X12	423706-131280	23.41		
1	1	C5365X16	423707-131280	34.36	421706	16.37
1-1/4	1-1/4	C5365X20	423708-131280	59.92		

90° Union Elbow Brazed



Tube O.D.	Vendor No.	Weatherhead		Utility	
		Part No.	Price /Each	Part No.	Price /Each
1/4	TF5505X4	423289-131280	\$4.06	420938	\$2.02
5/16	TF5505X5	423290-131280	4.32	420939	3.05
3/8	TF5505X6	423291-131280	4.63		
1/2	TF5505X8	423292-131280	5.51	420941	3.46
5/8	TF5505X10	423293-131280	7.82	420942	4.01
3/4	TF5505X12	423294-131280	10.97	420943	7.56
1	TF5505X16	423296-131280	18.15		
1-1/4	TF5505X20	423297-131280	30.31	420946	20.01
1-1/2	TF5505X24	423298-131280	49.74	420947	33.04
2				420948	115.24

STEEL SAE 37° (JIC) FLARE-TWIN

Steel SAE 37° (JIC) Flare-Twin Cont.



Weatherhead

90° Union Elbow Forged

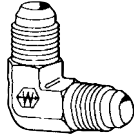

Tube O.D.	Vendor No.	Weatherhead		Utility	
		Part No.	Price /Each	Part No.	Price /Each
1/4	C5505X4	423940-131280	\$4.69	421709	\$2.07
3/8	C5505X6	423941-131280	5.67	421710	2.68
1/2	C5505X8	423942-131280	7.04	421711	3.57
5/8	C5505X10	423943-131280	8.93	421712	4.21
3/4	C5505X12	423944-131280	13.18	421713	7.73
1	C5505X16	423945-131280	18.80	421714	11.08

Bulkhead Union Elbow Brazed

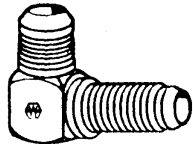

Tube O.D.	Vendor No.	Weatherhead		Utility	
		Part No.	Price /Each	Part No.	Price /Each
1/4	TF5525X4	423300-131280	\$5.87	420949	\$3.51
5/16	TF5525X5	423301-131280	7.71		
3/8	TF5525X6	423302-131280	6.22	420951	3.97
1/2	TF5525X8	423303-131280	8.40	420952	5.82
5/8	TF5525X10	423305-131280	11.35		
3/4	TF5525X12	423306-131280	17.18	420954	12.26
1	TF5525X16	423307-131280	24.17		

Bulkhead Union Elbow Forged



Tube O.D.	Vendor No.	Part No.	Price /Each
1/4	C5525X4	423946-131280	\$9.11
3/8	C5525X6	423947-131280	9.34
1/2	C5525X8	423948-131280	12.33
3/4	C5525X12	423950-131280	26.50
1	C5525X16	423951-131280	33.99

Swivel Nut 90° Elbow Brazed



Tube O.D.	Vendor No.	Part No.	Price /Each
1/4	TF5506X4	423380-131280	\$4.65
5/16	TF5506X5	423381-131280	5.30
3/8	TF5506X6	423382-131280	5.15
1/2	TF5506X8	423383-131280	7.03
5/8	TF5506X10	423384-131280	9.35
3/4	TF5506X12	423385-131280	13.39
7/8	TF5506X14	423386-131280	21.58
1	TF5506X16	423387-131280	22.26
1-1/4	TF5506X20	423388-131280	41.83
1-1/2	TF5506X24	423389-131280	61.41

Swivel Nut 90° Elbow Forged

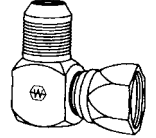

Tube O.D.	Vendor No.	Weatherhead		Utility	
		Part No.	Price /Each	Part No.	Price /Each
1/4	C5506X4	423992-131280	\$6.37	421028	\$2.68
5/16	C5506X5	423993-131280	7.19		
3/8	C5506X6	423994-131280	7.34	421030	2.99
1/2	C5506X8	423995-131280	9.16	421031	4.12
5/8	C5506X10	423996-131280	11.58		
3/4	C5506X12	423997-131280	16.25	421033	8.49
1	C5506X16	423998-131280	28.13	421035	14.14
1-1/4	C5506X20	423999-131280	50.71	421036	29.62
1-1/2				421037	46.02

90° Male Elbow Brazed



Tube O.D.	MPT	Vendor No.	Weatherhead		Utility	
			Part No.	Price /Each	Part No.	Price /Each
1/4	1/8	TF5405X4	423308-131280	\$3.25	420956	\$1.91
1/4	1/4	TF5405X4X4	423309-131280	3.84	420957	2.35
1/4	3/8	TF5405X4X6	423310-131280	5.13	420958	3.63
1/4	1/2	TF5405X4X8	423311-131280	7.04	420959	4.43
5/16	1/8	TF5405X5	423312-131280	4.04		
5/16	1/4	TF5405X5X4	423313-131280	3.97	420961	2.73
5/16	3/8	TF5405X5X6	423314-131280	6.30	420962	4.68
3/8	1/8	TF5405X6X2	423315-131280	4.34	420963	2.87
3/8	1/4	TF5405X6	423316-131280	3.70	420964	2.17
3/8	3/8	TF5405X6X6	423317-131280	8.04	420965	3.09
3/8	1/2	TF5405X6X8	423318-131280	6.58	420966	3.87
3/8	3/4	TF5405X6X12	0447701	15.51		
1/2	1/4	TF5405X8X4	423319-131280	5.59	420967	4.05
1/2	3/8	TF5405X8	423320-131280	5.32	420968	4.86
1/2	1/2	TF5405X8X8	423321-131280	6.68	420969	3.92
1/2	3/4	TF5405X8X12	423322-131280	9.97	420970	6.15
5/8	3/8	TF5405X10X6	423323-131280	6.95		
5/8	1/2	TF5405X10	423324-131280	7.28		
5/8	3/4	TF5405X10X12	423325-131280	10.33	420973	6.81
3/4	1/2	TF5405X12X8	423326-131280	10.62	420974	6.34
3/4	3/4	TF5405X12	423327-131280	10.42	420975	6.85
3/4	1	TF5405X12X16	423328-131280	15.37	420976	10.51
7/8	3/4	TF5405X14	423329-131280	14.97		
1	3/4	TF5405X16X12	423330-131280	15.74	420978	10.05
1	1	TF5405X16	423331-131280	17.32	420979	11.07
1	1-1/4	TF5405X16X20	423332-131280	32.96	420980	22.61
1-1/4	1	TF5405X20X16	423333-131280	32.16	420981	23.45
1-1/4	1-1/4	TF5405X20	423334-131280	32.94	420982	21.13
1-1/4	1-1/2	TF5405X20X24	423335-131280	49.72	420983	34.59
1-1/2	1-1/2	TF5405X24	423337-131280	47.30	420985	29.33
2	2	TF5405X32	423338-131280	97.67	420986	64.31

37° JIC Fittings

STEEL SAE 37° (JIC) FLARE-TWIN

Steel SAE 37° (JIC) Flare-Twin Cont.

EATON | Weatherhead

37° JIC Fittings

90° Male Elbow Forged

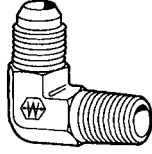

Tube O.D.	MPT	Vendor No.	Weatherhead		Utility	
			Part No.	Price /Each	Part No.	Price /Each
1/8	1/8	C5405X2	423953-131280	\$9.10	421715	\$6.28
3/16	1/8	C5405X3	423954-131280	5.73	421716	4.16
1/4	1/8	C5405X4	423955-131280	4.14	421717	2.01
1/4	1/4	C5405X4X4	423956-131280	4.71	421718	2.42
5/16	1/8	C5405X5	423957-131280	5.38	421719	2.32
5/16	1/4	C5405X5X4	423958-131280	5.59	421720	2.84
3/8	1/8	C5405X6X2	423959-131280	7.06	421721	2.99
3/8	1/4	C5405X6	423960-131280	5.18	421722	2.70
3/8	3/8	C5405X6X6	423961-131280	6.25	421723	3.33
3/8	1/2	C5405X6X8	423962-131280	9.33	421724	4.24
1/2	1/4	C5405X8X4	423963-131280	8.23	421725	4.11
1/2	3/8	C5405X8	423964-131280	6.37	421726	3.56
1/2	1/2	C5405X8X8	423965-131280	9.16	421727	3.87
1/2	3/4	C5405X8X12	423966-131280	15.23	421728	6.43
5/8	3/8	C5405X10X6	423967-131280	10.17	421729	4.37
5/8	1/2	C5405X10	423968-131280	8.72	421730	4.64
5/8	3/4	C5405X10X12	423969-131280	11.94	421731	6.70
3/4	1/2	C5405X12X8	423970-131280	13.03	421732	6.65
3/4	3/4	C5405X12	423971-131280	11.67	421733	7.08
1	3/4	C5405X16X12	423972-131280	25.77	421734	9.79
1	1	C5405X16	423973-131280	21.95	421735	11.21
1-1/4	1	C5405X20X16	423974-131280	40.98	421736	22.15
1-1/4	1-1/4	C5405X20	423975-131280	33.65	421737	22.45
1-1/2	1-1/2	C5405X24	423976-131280	55.58		
2	2	C5405X32	423977-131280	97.50		

90° Male Elbow Long Brazed

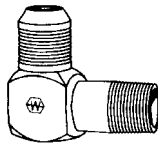

Tube O.D.	MPT	Vendor No.	Part No.	Price /Each
1/4	1/8	TF5425X4	423339-131280	\$5.78
1/4	1/4	TF5425X4X4	423340-131280	6.23
5/16	1/4	TF5425X5X4	423341-131280	6.61
3/8	1/4	TF5425X6	423342-131280	6.30
3/8	3/8	TF5425X6X6	423343-131280	9.87
1/2	3/8	TF5425X8	423344-131280	8.65
1/2	1/2	TF5425X8X8	423345-131280	11.00
1/2	3/4	F5425X8X12	423346-131280	17.64
5/8	1/2	TF5425X10	423347-131280	12.08
3/4	3/4	TF5425X12	423348-131280	16.22
1	1	TF5425X16	423350-131280	23.39
1-1/4	1-1/4	TF5425X20	423351-131280	61.63

90° Male Elbow Long Forged

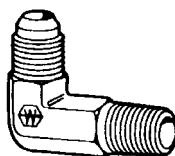

Tube O.D.	MPT	Vendor No.	Part No.	Price /Each
3/8	1/4	C5425X6	423978-131280	\$8.70
3/4	3/4	C5425X12	423979-131280	23.00

90° Male Elbow Extra Long Brazed

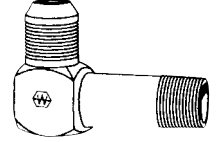

Tube O.D.	MPT	Vendor No.	Weatherhead		Utility	
			Part No.	Price /Each	Part No.	Price /Each
1/4	1/8	TF5435X4	423353-131280	\$6.10	421001	\$4.12
1/4	1/4	TF5435X4X4	423354-131280	6.52	421002	4.47
5/16	1/4	TF5435X5X4	423356-131280	8.81		
3/8	1/4	TF5435X6	423357-131280	6.78		
3/8	3/8	TF5435X6X6	0447703	10.98		
1/2	3/8	TF5435X8	423358-131280	8.93	421006	5.87
1/2	1/2	TF5435X8X8	423359-131280	11.36	421007	7.47
5/8	1/2	TF5435X10	423360-131280	12.06	421008	8.19
3/4	3/4	TF5435X12	423361-131280	17.57	421009	12.00
1	1	TF5435X16	423363-131280	30.71	421011	22.18
1-1/4	1-1/4	TF5435X20	423364-131280	85.38		

90° Female Elbow Brazed

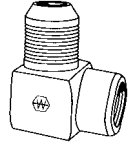

Tube O.D.	FPT	Vendor No.	Weatherhead		Utility	
			Part No.	Price /Each	Part No.	Price /Each
1/4	1/8	TF5455X4	423365-131280	\$3.97	421013	\$2.63
1/4	1/4	TF5455X4X4	423366-131280	4.62	421014	3.55
5/16	1/8	TF5455X5	423367-131280	5.11	421015	3.68
3/8	1/4	TF5455X6	423369-131280	4.38	421017	2.99
3/8	3/8	TF5455X6X6	423370-131280	6.03	421018	3.96
1/2	3/8	TF5455X8	423371-131280	6.31		
1/2	1/2	TF5455X8X8	423372-131280	9.35	421020	6.18
3/4	3/4	TF5455X12	423374-131280	13.90	421022	9.27
1	1	TF5455X16	423376-131280	21.59	421024	13.91
1-1/4	1-1/4	TF5455X20	423377-131280	42.40	421025	28.77
1-1/2	1-1/2	TF5455X24	423378-131280	62.58		

90° Female Elbow Forged

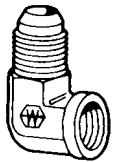

Tube O.D.	FPT	Vendor No.	Weatherhead		Utility	
			Part No.	Price /Each	Part No.	Price /Each
1/4	1/8	C5455X4	423980-131280	\$6.02	421742	\$2.84
3/8	1/8	C5455X6X2	423981-131280	8.87		
3/8	1/4	C5455X6	423982-131280	7.15	421744	3.30
3/8	3/8	C5455X6X6	423983-131280	10.40	421745	4.01
1/2	1/4	C5455X8X4	423984-131280	11.71	421746	8.36
1/2	3/8	C5455X8	423985-131280	10.68	421747	4.21
1/2	1/2	C5455X8X8	423986-131280	14.34	421748	6.03
5/8	1/2	C5455X10	423987-131280	15.01	421749	7.72
3/4	1/2	C5455X12X8	423988-131280	20.86		
3/4	3/4	C5455X12	423989-131280	23.06	421751	9.91
7/8	3/4	C5455X14	423990-131280	25.70		
1	1	C5455X16	423991-131280	28.97	421753	15.20

STEEL SAE 37° (JIC) FLARE-TWIN

Steel SAE 37° (JIC) Flare-Twin Cont.



Weatherhead

90° Male Pipe to JIC Swivel Brazed

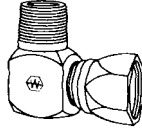

Tube O.D.	MPT	Vendor No.	Weatherhead		Utility	
			Part No.	Price /Each	Part No.	Price /Each
1/4	1/8	TF5406X4	423391-131280	\$4.68	421039	\$3.09
3/8	1/4	TF5406X6	423392-131280	5.52		
1/2	3/8	TF5406X8	423393-131280	7.89	421041	7.52
5/8	1/2	TF5406X10	423394-131280	9.91	421042	6.97
3/4	3/4	TF5406X12	423395-131280	14.36	421043	10.27
1	1	TF5406X16	423396-131280	24.50	421044	18.31
1-1/4	1-1/4	TF5406X20	423397-131280	48.25	421045	33.48
1-1/2	1-1/2	TF5406X24			421046	50.10

Straight Thread O-Ring 90° Elbow Brazed

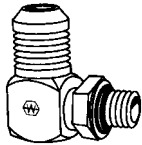

Tube O.D.	Port	Vendor No.	Weatherhead		Utility	
			Part No.	Price /Each	Part No.	Price /Each
1/4	1/4	TF5515X4	423400-131280	\$5.20	421048	\$2.99
1/4	5/16	TF5515X4X5	423401-131280	5.77	421049	4.10
1/4	3/8	TF5515X4X6	423402-131280	6.19	421050	3.96
5/16	1/4	TF5515X5X4	423403-131280	6.79	421051	4.66
5/16	5/16	TF5515X5	423404-131280	5.48	421052	3.84
5/16	3/8	TF5515X5X6	423405-131280	6.89	421053	5.00
3/8	1/4	TF5515X6X4	423406-131280	5.91	421054	3.82
3/8	5/16	TF5515X6X5	423407-131280	6.88	421055	4.80
3/8	3/8	TF5515X6	423408-131280	5.90	421056	3.46
3/8	1/2	TF5515X6X8	423409-131280	7.95	421057	4.74
3/8	5/8	TF5515X6X10	423410-131280	10.10		
1/2	3/8	TF5515X8X6	423411-131280	7.63	421059	4.92
1/2	1/2	TF5515X8	423412-131280	7.70	421060	4.54
1/2	5/8	TF5515X8X10	423413-131280	9.30	421061	5.41
1/2	3/4	TF5515X8X12	423414-131280	14.81	421062	8.76
5/8	1/2	TF5515X10X8	423415-131280	9.18	421063	6.38
5/8	5/8	TF5515X10	423416-131280	10.11	421064	6.96
5/8	3/4	TF5515X10X12	423417-131280	15.27		
3/4	1/2	TF5515X12X8	423418-131280	12.06	421066	8.40
3/4	5/8	TF5515X12X10	423419-131280	13.91	421067	9.91
3/4	3/4	TF5515X12	423420-131280	14.83	421068	9.24
3/4	7/8	TF5515X12X14	423421-131280	24.14		
7/8	7/8	TF5515X14	0400614	20.53		
3/4	1	TF5515X12X16	423422-131280	22.14	421070	13.51
1	3/4	TF5515X16X12	423423-131280	20.72	421071	13.03
1	7/8	TF5515X16X14	423424-131280	21.93		
1	1	TF5515X16	423425-131280	23.06	421073	14.99
1	1-1/4	TF5515X16X20	423426-131280	38.33	421074	15.71
1-1/4	1	TF5515X20X16	423427-131280	37.17	421075	27.72
1-1/4	1-1/4	TF5515X20	423428-131280	37.78		
1-1/2	1-1/4	TF5515X24X20	423429-131280	48.96	421077	42.14
1-1/2	1-1/2	TF5515X24	423430-131280	57.86	421078	33.99
2	2	TF5515X32	423431-131280	245.70	421079	169.22

Straight Thread O-Ring 90° Elbow Forged

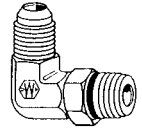

Tube O.D.	Port	Vendor No.	Weatherhead		Utility	
			Part No.	Price /Each	Part No.	Price /Each
3/16	3/16	C5515X3	423837-131280	\$11.87		
1/4	1/4	C5515X4	423838-131280	6.54		
5/16	5/16	C5515X5	423839-131280	7.26		
3/8	3/8	C5515X6	423840-131280	7.47		
3/8	1/2	C5515X6X8	423841-131280	8.38		
1/2	3/8	C5515X8X6	423842-131280	9.61		
1/2	1/2	C5515X8	423843-131280	8.95		
1/2	5/8	C5515X8X10	423844-131280	11.39		
5/8	5/8	C5515X10	423845-131280	11.48		
3/4	5/8	C5515X12X10	423846-131280	20.33		
3/4	3/4	C5515X12	423847-131280	16.35		
7/8	7/8	C5515X14	423848-131280	25.93		
1	3/4	C5515X16X12	423849-131280	26.03		
1	1	C5515X16	423850-131280	26.68		
1-1/4	1-1/4	C5515X20	423851-131280	47.18		
1-1/2	1-1/2	C5515X24	423852-131280	68.73		

Straight Thread O-Ring 90° Elbow Long

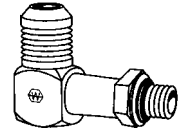

Tube O.D.	Port	Vendor No.	Weatherhead		Utility	
			Part No.	Price /Each	Part No.	Price /Each
3/8	3/8	TF5515X6L	423432-131280	\$7.72	421080	\$4.86
1/2	1/2	TF5515X8L	423433-131280	10.97	421081	7.24
5/8	5/8	TF5515X10L	423434-131280	14.03		
3/4	3/4	TF5515X12L	423435-131280	25.99		

Straight Thread O-Ring 90° Elbow Extra Long

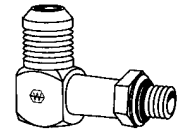

Tube O.D.	Port	Vendor No.	Weatherhead		Utility	
			Part No.	Price /Each	Part No.	Price /Each
3/8	3/8	TF5515X6LL	421754	\$5.21		
1/2	1/2	TF5515X8LL	421755	11.11		
3/4	3/4	TF5515X12LL	421757	15.20		

Union Tee Brazed

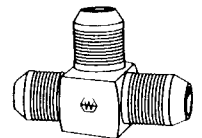

Tube O.D.	Vendor No.	Weatherhead		Utility	
		Part No.	Price /Each	Part No.	Price /Each
1/4 x 1/4 x 1/4	TF5705X4	423440-131280	\$5.42	421084	\$3.46
5/16 x 5/16 x 5/16	TF5705X5	423441-131280	5.87		
3/8 x 3/8 x 3/8	TF5705X6	423442-131280	5.70	421086	3.56
1/2 x 1/2 x 1/2	TF5705X8	423443-131280	7.67	421087	5.72
5/8 x 1/2 x 1/2	TF5705X10X8	423444-131280	11.25	421088	11.23
5/8 x 5/8 x 5/8	TF5705X10	423445-131280	10.20	421089	6.68
5/8 x 5/8 x 1/2	TF5705X10X10X8	423446-131280	11.31		
3/4 x 3/4 x 3/4	TF5705X12	423447-131280	15.00	421091	10.36
1 x 1 x 1	TF5705X16	423449-131280	23.40	421093	15.15
1-1/2 x 1-1/2 x 1-1/2	TF5705X24	423451-131280	71.64	421095	52.12

37° JIC Fittings

STEEL SAE 37° (JIC) FLARE-TWIN

Steel SAE 37° (JIC) Flare-Twin Cont.



Weatherhead

Union Tee
Forged

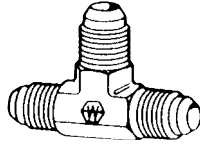

Tube O.D.	Vendor No.	Weatherhead		Utility	
		Part No.	Price /Each	Part No.	Price /Each
1/8	C5705X2	424600-131280	\$24.39		
3/16	C5705X3	424601-131280	16.07	421759	15.56
1/4	C5705X4	424602-131280	6.98	421760	3.55
3/8	C5705X6	424603-131280	7.68	421761	3.30
1/2	C5705X8	424604-131280	11.93	421762	5.15
5/8	C5705X10	424605-131280	14.13	421763	6.34
3/4	C5705X12	424606-131280	19.77	421764	9.53
7/8	C5705X14			421765	21.55
1	C5705X16	424608-131280	30.33	421766	14.68
1-1/4	C5705X20	424609-131280	52.63		

Male Run Tee
Brazed

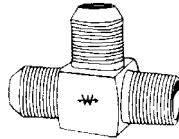

Tube O.D.	MPT	Vendor No.	Weatherhead		Utility	
			Part No.	Price /Each	Part No.	Price /Each
1/4	1/8	TF5755X4	423453-131280	\$5.37		
1/4	1/4	TF5755X4X4	423454-131280	7.75	421098	5.17
5/16	1/8	TF5755X5	423455-131280	5.78		
3/8	1/4	TF5755X6	423456-131280	5.72		
3/8	3/8	TF5755X6X6X6	423457-131280	8.64	421101	6.29
1/2	3/8	TF5755X8	423458-131280	8.40	421102	6.40
1/2	1/2	TF5755X8X8X8	423459-131280	11.56	421103	7.58
5/8	1/2	TF5755X10	423460-131280	10.49		
3/4	3/4	TF5755X12	423461-131280	14.99		
1	1	TF5755X16	423463-131280	26.32		
1-1/4	1-1/4	TF5755X20	423464-131280	48.25	421108	38.04

Male Run Tee
Forged

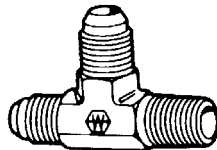

Tube O.D.	MPT	Vendor No.	Weatherhead		Utility	
			Part No.	Price /Each	Part No.	Price /Each
1/4	1/8	C5755X4	424610-131280	\$6.12	421768	\$3.61
3/8	1/4				421769	4.16
1/2	3/8	C5755X8	424612-131280	10.84	421770	6.67
5/8	1/2	C5755X10	424613-131280	14.13	421771	7.47
3/4	3/4	C5755X12	424614-131280	22.31		
1	1	C5755X16	424615-131280	33.64		

Swivel Nut Run Tee
Brazed

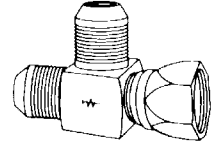

Tube O.D.	Vendor No.	Weatherhead		Utility	
		Part No.	Price /Each	Part No.	Price /Each
1/4	TF5706X4	423474-131280	\$6.94	421118	\$4.74
5/16	TF5706X5	423475-131280	9.53		
3/8	TF5706X6	423476-131280	7.04	421120	4.74
1/2	TF5706X8	423477-131280	10.47	421121	6.79
5/8	TF5706X10	423478-131280	13.91		
3/4	TF5706X12	423479-131280	21.20	421123	12.93
1	TF5706X16	423481-131280	28.91	421125	19.16
1-1/4	TF5706X20	423482-131280	55.59	421126	37.08
1-1/2	TF5706X24	423483-131280	72.90		

Swivel Nut Run Tee
Forged

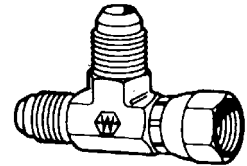

Tube O.D.	Vendor No.	Weatherhead		Utility	
		Part No.	Price /Each	Part No.	Price /Each
1/4	C5706X4	424616-131280	\$8.98	421774	\$4.56
5/16	C5706X5	424617-131280	16.80	421775	6.41
3/8	C5706X6	424618-131280	12.78	421776	4.26
1/2	C5706X8	424619-131280	19.63	421777	6.55
5/8	C5706X10	424620-131280	19.18	421778	8.81
3/4	C5706X12	424621-131280	26.02	421779	12.28
1	C5706X16	424622-131280	36.55	421780	19.20
1-1/4	C5706X20	424623-131280	64.47		

Bulkhead Run Tee
Brazed

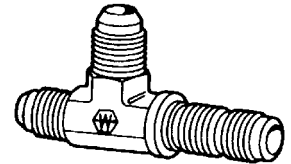

Tube O.D.	Vendor No.	Weatherhead		Utility	
		Part No.	Price /Each	Part No.	Price /Each
1/2	TF5726X8	423485-131280	\$26.36	421129	\$18.93

Bulkhead Run Tee
Forged



Tube O.D.	Vendor No.	Part No.	Price /Each
3/8	C5720X6	0446814	\$18.53

37° JIC Fittings

STEEL SAE 37° (JIC) FLARE-TWIN

Steel SAE 37° (JIC) Flare-Twin Cont.



Weatherhead

Straight Thread O-Ring Run Tee Brazed

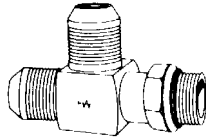

Tube O.D.	Port	Vendor No.	Weatherhead		Utility	
			Part No.	Price /Each	Part No.	Price /Each
1/4	1/4	TF5716X4	423486-131280	\$7.49		
3/8	3/8	TF5716X6	423488-131280	7.83		
1/2	1/2	TF5716X8	423489-131280	10.97		
5/8	5/8	TF5716X10	423490-131280	14.85	421134	10.11
3/4	3/4	TF5716X12	423491-131280	20.46	421135	14.61
7/8	7/8	TF5716X14	423492-131280	36.45	421136	30.92
1	1	TF5716X16	423493-131280	31.47		

Straight Thread O-Ring Run Tee Forged

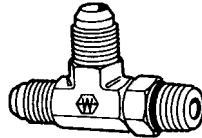

Tube O.D.	Port	Vendor No.	Part No.	Price /Each
1/4	1/4	C5716X4	423780-131280	\$11.00
5/16	5/16	C5716X5	423781-131280	14.48
3/8	3/8	C5716X6	423782-131280	12.06
1/2	1/2	C5716X8	423783-131280	16.11
5/8	5/8	C5716X10	423784-131280	24.15
3/4	3/4	C5716X12	423785-131280	36.57
1	1	C5716X16	423786-131280	55.57

Male Branch Tee Brazed

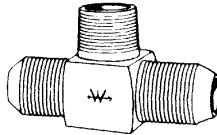

Tube O.D.	MPT	Vendor No.	Weatherhead		Utility	
			Part No.	Price /Each	Part No.	Price /Each
1/4	1/8	TF5605X4	423496-131280	\$5.59	421140	\$3.82
1/4	1/4	TF5605X4X4X4	423497-131280	6.22	421141	4.11
5/16	1/8	TF5605X5	423498-131280	6.68	421142	4.81
3/8	1/4	TF5605X6	423499-131280	5.53	421143	3.61
3/8	3/8	TF5605X6X6X6	423500-131280	7.83	421144	5.27
1/2	3/8	TF5605X8	423501-131280	7.90	421145	5.12
1/2	1/2	TF5605X8X8X8	423502-131280	10.19	421146	6.41
5/8	1/2	TF5605X10	423503-131280	10.25	421147	6.85
3/4	3/4	TF5605X12	423504-131280	14.34	421148	10.30
7/8	3/4				421149	29.38
1	1	TF5605X16	423506-131280	22.22	421150	14.94
1-1/4	1-1/4				421793	40.71
1-1/2	1-1/2				421794	69.85
2	2				421795	214.83

Male Branch Tee Forged

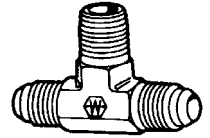

Tube O.D.	MPT	Vendor No.	Part No.	Price /Each
1/4	1/8	C5605X4	424624-131280	\$5.86
1/4	1/4	C5605X4X4X4	424625-131280	7.70
5/16	1/8	C5605X5	424626-131280	8.30
3/8	1/4	C5605X6	424627-131280	7.26
1/2	3/8	C5605X8	424628-131280	10.69
5/8	1/2	C5605X10	424629-131280	14.04
3/4	3/4	C5605X12	424630-131280	20.28
1	1	C5605X16	424631-131280	35.85

Female Branch Tee Brazed

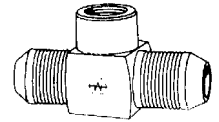

Tube O.D.	FPT	Vendor No.	Part No.	Price /Each
1/4	1/4	TF5655X4X4X4	423510-131280	\$8.65
5/16	1/8	TF5655X5	423511-131280	7.68
3/8	1/4	TF5655X6	423512-131280	6.95
3/8	3/8	TF5655X6X6X6	423513-131280	9.52
1/2	3/8	TF5655X8	423514-131280	9.50
1/2	1/2	TF5655X8X8X8	423515-131280	18.58
3/4	3/4	TF5655X12	423517-131280	19.78
1	1	TF5655X16	423519-131280	32.89

Swivel Nut Branch Tee Brazed

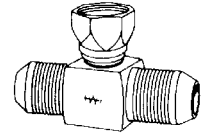

Tube O.D.	Vendor No.	Weatherhead		Utility	
		Part No.	Price /Each	Part No.	Price /Each
1/4	TF5707X4	423523-131280	\$6.44	421164	\$4.44
5/16	TF5707X5	423524-131280	8.05		
3/8	TF5707X6	423525-131280	7.05	421166	4.54
1/2	TF5707X8	423526-131280	10.19	421167	6.55
5/8	TF5707X10	423527-131280	12.81		
3/4	TF5707X12	423528-131280	18.31		
1	TF5707X16	423530-131280	27.06	421171	18.85
1-1/4	TF5707X20	423531-131280	70.19	421172	53.10

Swivel Nut Branch Tee Forged

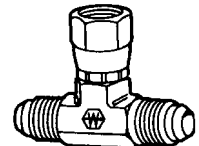

Tube O.D.	Vendor No.	Weatherhead		Utility	
		Part No.	Price /Each	Part No.	Price /Each
3/8	C5707X6	424636-131280	\$10.09	421806	\$4.64
3/4	C5707X12	424637-131280	25.98	421807	12.26
1	C5707X16	424638-131280	37.31	421808	19.19

37° JIC Fittings

STEEL SAE 37° (JIC) FLARE-TWIN

Steel SAE 37° (JIC) Flare-Twin Cont.

FATON | Weatherhead

37° JIC Fittings

Bulkhead Union Tee Brazed



Tube O.D.	Vendor No.	Part No.	Price /Each
3/8	TF5725X6	423535-131280	\$12.30
1/2	TF5725X8	423536-131280	15.73
3/4	TF5725X12	423538-131280	35.11

Straight Thread O-Ring Branch Tee

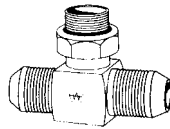

Tube O.D.	Port	Vendor No.	Weatherhead		Utility	
			Part No.	Price /Each	Part No.	Price /Each
1/4	1/4	TF5715X4	423539-131280	\$6.62	421180	\$4.75
5/16	5/16	TF5715X5	423540-131280	7.72		
3/8	3/8	TF5715X6	423541-131280	7.82	421182	5.49
1/2	1/2	TF5715X8	423542-131280	10.63		
5/8	5/8	TF5715X10	423543-131280	14.05	421184	9.54
3/4	3/4	TF5715X12	423544-131280	19.02	421185	14.36
7/8	7/8	TF5715X14			421186	27.72
1	1	TF5715X16	423546-131280	30.69		

Cross Brazed

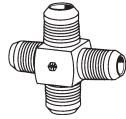

Tube O.D.	Vendor No.	Weatherhead		Utility	
		Part No.	Price /Each	Part No.	Price /Each
1/4	TF5955X4	423549-131280	\$10.91	421190	\$7.46
3/8	TF5955X6	423551-131280	11.79	421192	7.08
1/2	TF5955X8	423552-131280	13.89	421193	7.63
5/8	TF5955X10	423553-131280	20.22		
3/4				421195	18.03
1				421197	29.94

O-Ring

- 90 Durometer
- Nitrile



Tube O.D.	Vendor No.	Part No.	Price /Each
1/16	7629X1	420415-131280	\$0.08
1/8	7629X2	420416-131280	0.30
3/16	7629X3	420417-131280	0.32
1/4	7629X4	420418-131280	0.25
5/16	7629X5	420419-131280	0.46
3/8	7629X6	420420-131280	0.49
7/16	7629X7	420421-131280	0.48
1/2	7629X8	420422-131280	0.49
5/8	7629X10	420423-131280	0.54
3/4	7629X12	420424-131280	0.57
7/8	7629X14	420425-131280	1.27
1	7629X16	420426-131280	1.34
1-1/4	7629X20	420427-131280	1.39
1-1/2	7629X24	420428-131280	1.58
2	7629X32	420429-131280	1.90

Stainless Steel 37° JIC Tube Fittings

Cap Nut

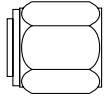

Tube O.D.	Utility Part No.	Price /Each
3/16	425322	\$12.70
1/4	425323	6.16
5/16	425324	12.39
3/8	425325	7.03
1/2	425326	8.10
5/8	425327	22.77
3/4	425328	27.32
1	425329	41.78
1-1/4	425330	84.98

Bulkhead Nut



Tube O.D.	Utility Part No.	Price /Each
1/4	425334	\$3.65
3/8	425336	4.08
1/2	425337	5.90
3/4	425339	15.26
1	425340	18.29

Tube Nut

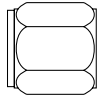

Tube O.D.	Utility Part No.	Price /Each
1/8	425344	\$3.12
3/16	425345	2.80
1/4	425346	2.21
5/16	425347	3.84
3/8	425348	3.50
1/2	425349	4.40
5/8	425350	10.03
3/4	425351	15.48
1	425353	24.21

Tube Sleeve

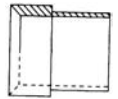

Tube O.D.	Utility Part No.	Price /Each
3/16	425358	\$2.04
1/4	425359	1.16
5/16	425360	1.78
3/8	425361	1.87
1/2	425362	3.12
5/8	425363	4.40
3/4	425364	5.90
1	425366	11.25

STAINLESS STEEL 37° JIC TUBE FITTINGS, FOR-SEAL

Stainless Steel 37° JIC Tube Fittings Cont.

Straight Tube Union

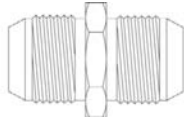

Tube O.D.	Part No.	Price /Each
1/8	425370	\$36.35
1/4	425373	8.50
5/16	425375	11.52
3/8 x1/4	425376	26.47
3/8	425377	10.13
1/2 x3/8	425379	72.03
1/2 x1/2	425380	14.85
5/8	425383	27.30
3/4 x1/2	425385	65.28
3/4	425387	41.09
1	425392	48.97

Male Straight Adapter

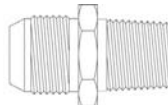

Tube O.D.	NPTF	Part No.	Price /Each
1/8	1/8	425421	\$10.98
1/4	1/8	425423	9.48
1/4	1/4	425424	6.70
1/4	3/8	425425	32.41
1/4	1/2	425426	28.39
5/16	1/4	425428	8.84
5/16	3/8	425429	142.98
3/8	1/8	425430	11.25
3/8	1/4	425431	11.24
3/8	3/8	425432	9.54
3/8	1/2	425433	14.47
1/2	1/4	425435	12.06
1/2	3/8	425436	11.79
1/2	1/2	425437	13.83
1/2	3/4	425438	26.78
1/2	1	425439	85.55
5/8	3/8	425440	20.63
5/8	1/2	425441	18.09
5/8	3/4	425442	87.79
5/8	1	425443	77.39
3/4	3/8	425444	89.49
3/4	1/2	425445	28.66
3/4	3/4	425446	27.00
3/4	1	425447	71.50
7/8	3/4	425448	95.76
1	1/2	425449	85.29
1	3/4	425450	44.46
1	1	425451	41.25
1	1-1/4	425452	129.78
1-1/4	1-1/4	425455	76.59

Straight Tube Union Large Hex

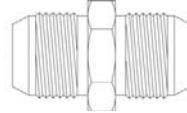

Tube O.D.	Part No.	Price /Each
1/4	425403	\$11.54
3/8 x1/4	425405	17.95
3/8 x5/16	425406	53.03
3/8	425407	15.54
1/2	425410	22.23
5/8 x1/2	425411	91.52
5/8	425412	48.21
3/4	425415	43.34

Male NPT Bulkhead

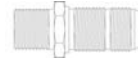

Tube O.D.	NPTF	Part No.	Price /Each
1/4	1/8	425803	\$88.35
1/4	1/4	425804	75.42
3/8	1/4	425805	68.54
3/8	3/8	425806	99.55
1/2	3/8	425807	89.81
1/2	1/2	425808	106.09
3/4	3/4	425810	253.26

90° Swivel Elbow

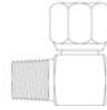

Tube O.D.	Part No.	Price /Each
1/4	425814	\$16.07
5/16	425815	118.19
3/8	425816	26.25
1/2	425817	39.64
3/4	425819	72.84
1	425820	122.74

Male Straight Swivel Adapter

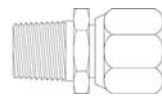

Tube O.D.	NPTF	Part No.	Price /Each
1/4	1/8	425840	\$64.15
1/4	1/4	425841	65.56
3/8	1/4	425843	92.65
3/8	3/8	425844	70.96
1/2	3/8	425845	98.90
1/2	1/2	425846	86.76
3/4	3/4	425850	112.48
1	1	425851	179.02

Female Straight Swivel Adapter

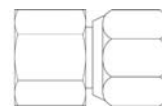

Tube O.D.	NPTF	Part No.	Price /Each
1/4	1/4	425856	\$86.67
3/8	3/8	425860	71.23
1/2	1/2	425862	100.96
3/4	3/4	425865	143.07
1	1	425867	140.91
1-1/2	1-1/2	425869	236.39

Swivel Outlet Tee

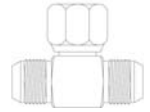

Tube O.D.	Part No.	Price /Each
1/4	425871	\$25.71
3/8	425873	33.77
1/2	425874	56.55
3/4	425876	126.09
1	425877	203.80
1-1/4	425878	422.10

Swivel Run Tee

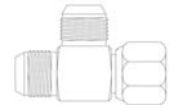

Tube O.D.	Part No.	Price /Each
1/4	425881	\$25.71
3/8	425883	32.14
1/2	425884	50.62

For-Seal



Bulkhead Nut

- Typical Application: High pressure hydraulic, pneumatic and chemical processing.
- Pressure: Operating pressure to 6000 psi
- Sealing Method: Face O-Ring
- Vibration: Excellent resistance.
- Material: 12L14 Steel
- Plating: All fittings are zinc plated, except brazed parts which are oil dipped.
- Used with: Steel and stainless steel tubing (tubing for brazing must be non-coated)
- Advantages: Tubing is brazed for permanent leakproof connection.
- Conformance: Meets SAE J1453.
- How to Order: Individually by catalog number O-Ring supplied with fittings.



Tube O.D.	Vendor No.	Part No.	Price /Each
3/8	4924X6	442032-131280	\$3.92
1/2	4924X8	442033-131280	6.25
3/4	4924X12	442034-131280	7.20
1	4924X16	442035-131280	8.50
1-1/4	4924X20	442036-131280	15.61
1-1/2	4924X24	442037-131280	23.09

Cap



Tube O.D.	Vendor No.	Part No.	Price /Each
1/4	4129X4	442038-131280	\$2.73
3/8	4129X6	442039-131280	3.77
1/2	4129X8	442040-131280	5.14
5/8	4129X10	442041-131280	9.83
3/4	4129X12	442042-131280	9.93
1	4129X16	442043-131280	13.42
1-1/4	4129X20	442044-131280	19.48
1-1/2	4129X24	442045-131280	43.80

FOR-SEAL, FLARELESS ERMETO® FITTINGS

For-Seal Cont.

FATON

Weatherhead

Steel Fittings

Plug

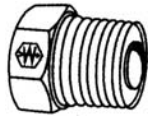

Tube O.D.	Vendor No.	Part No.	Price /Each
1/4	4229X4	442046-131280	\$2.44
3/8	4229X6	442047-131280	3.38
1/2	4229X8	442048-131280	4.76
5/8	4229X10	442049-131280	6.03
3/4	4229X12	442050-131280	7.72
1	4229X16	442051-131280	13.15
1-1/4	4229X20	442052-131280	21.04
1-1/2	4229X24	442053-131280	36.09

Union



Tube O.D.	Vendor No.	Part No.	Price /Each
1/4 x 1/4	4305X4	442054-131280	\$2.70
3/8 x 1/4	4305X6X4	442055-131280	14.82
3/8 x 3/8	4305X6	442056-131280	2.79
1/2 x 3/8	4305X8X6	442057-131280	8.62
1/2 x 1/2	4305X8	442058-131280	4.75
5/8 x 1/2	4305X10X8	442059-131280	18.29
5/8 x 5/8	4305X10	442060-131280	5.92
3/4 x 1/2	4305X12X8	442061-131280	13.90
3/4 x 5/8	4305X12X10	442062-131280	16.25
3/4 x 3/4	4305X12	442063-131280	8.19
1 x 3/4	4305X16X12	442064-131280	34.34
1 x 1	4305X16	442065-131280	10.34
1-1/4 x 1-1/4	4305X20	442066-131280	35.20

Bulkhead Union



Tube O.D.	Vendor No.	Part No.	Price /Each
3/8	4325X6	442093-131280	\$9.53
1/2	4325X8	442094-131280	11.00
3/4	4325X12	442095-131280	26.66
1	4325X16	442096-131280	40.51

Male 37 JIC to Female FOR-SEAL



Tube O.D.	Flare	Vendor No.	Part No.	Price /Each
1/4	1/4	4213X4	442099-131280	\$16.54
3/8	3/8	4213X6	442100-131280	21.58
1/2	1/2	4213X8	442101-131280	22.66
5/8	5/8	4213X10	442102-131280	29.74
3/4	3/4	4213X12	442103-131280	47.16
1	1	4213X16	442104-131280	56.48

Male For-Seal to Male Pipe Adapter



Tube O.D.	MPT	Vendor No.	Part No.	Price /Each
3/8	3/8	4205X6X6	442105-131280	\$3.76
1/2	3/8	4205X8	442106-131280	5.79
1/2	1/2	4205X8X8	442107-131280	6.43
5/8	1/2	4205X10	442108-131280	13.64
3/4	1/2	4205X12X8	442109-131280	13.34
3/4	3/4	4205X12	442110-131280	7.32
3/4	1	4205X12X16	442111-131280	21.25
1	1	4205X16	442112-131280	11.19
1-1/4	1-1/4	4205X20	442113-131280	35.57

O-Ring

- 90 Durometer
- Nitrile



Tube O.D.	Vendor No.	Part No.	Price /Each
1/4	4629X4	442135-131280	\$0.08
3/8	4629X6	442136-131280	0.08
1/2	4629X8	442137-131280	0.13
5/8	4629X10	442138-131280	0.13
3/4	4629X12	442139-131280	0.20
1	4629X16	442140-131280	0.20
1-1/4	4629X20	442141-131280	0.34
1-1/2	4629X24	442142-131280	0.39

Flareless Ermeto® Fittings

FATON

Weatherhead

Ermeto® Fittings (7000 Series) are especially designed for making leak-proof tube connections. This fitting will effectively withstand high pressure, severe vibration and extreme temperature. No special tools are needed for assembly. Simply cut tube square, preset sleeve on tubing and assemble.



Sleeve

Tube O.D.	Vendor No.	Part No.	Price /Each
1/8	7165X2	420113-131280	\$0.58
3/16	7165X3	420114-131280	0.64
1/4	7165X4	420115-131280	0.70
5/16	7165X5	420116-131280	1.02
3/8	7165X6	420117-131280	1.01
1/2	7165X8	420118-131280	1.11
5/8	7165X10	420119-131280	1.47
3/4	7165X12	420120-131280	2.20
7/8	7165X14	420121-131280	2.68
1	7165X16	420122-131280	3.86
1-1/4	7165X20	420123-131280	4.95
1-1/2	7165X24	420124-131280	5.86

Nut

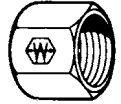

Tube O.D.	Vendor No.	Part No.	Price /Each
1/8	7105X2	420129-131280	\$0.95
3/16	7105X3	420130-131280	1.04
1/4	7105X4	420131-131280	1.02
5/16	7105X5	420132-131280	0.97
3/8	7105X6	420133-131280	1.08
1/2	7105X8	420134-131280	1.71
5/8	7105X10	420135-131280	2.18
3/4	7105X12	420136-131280	2.64
7/8	7105X14	420137-131280	4.32
1	7105X16	420138-131280	4.35
1-1/4	7105X20	420139-131280	10.34
1-1/2	7105X24	420140-131280	14.22

Bulkhead Nut

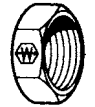

Tube O.D.	Vendor No.	Part No.	Price /Each
1/4	7924X4	420147-131280	\$0.91
3/8	7924X6	420148-131280	0.87
1/2	7924X8	420149-131280	1.00
5/8	7924X10	420150-131280	1.64
3/4	7924X12	420151-131280	3.09
1	7924X16	420153-131280	4.52

Cap

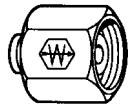

Tube O.D.	Vendor No.	Part No.	Price /Each
1/4	7129X4	420161-131280	\$4.09
3/8	7129X6	420162-131280	5.01
1/2	7129X8	420163-131280	5.86
5/8	7129X10	420164-131280	8.90
3/4	7129X12	420165-131280	8.36
1	7129X16	420166-131280	12.40
1-1/4	7129X20	420167-131280	28.20

Plug

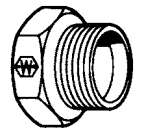

Tube O.D.	Vendor No.	Part No.	Price /Each
1/8	7229X2	420168-131280	\$7.33
1/4	7229X4	420169-131280	3.30
5/16	7229X5	420170-131280	8.86
3/8	7229X6	420171-131280	4.12
1/2	7229X8	420172-131280	5.25
5/8	7229X10	420173-131280	10.59
3/4	7229X12	420174-131280	12.02
1	7229X16	420175-131280	14.75

Flareless Ermeto® Fittings Cont.



Weatherhead

Reducer

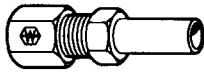

Body	Tube O.D.	Vendor No.	Part No.	Price /Each
3/8	1/4	7015X6X4	420210-131280	\$4.67
1/2	1/4	7015X8X4	420211-131280	6.84
1/2	3/8	7015X8X6	420212-131280	6.97
3/4	3/8	7015X12X6	420214-131280	11.88
3/4	1/2	7015X12X8	420215-131280	12.07

Small Hex Union

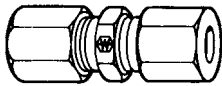

Tube O.D.	Vendor No.	Part No.	Price /Each
1/8	7305X2	420218-131280	\$7.51
3/16	7305X3	420219-131280	6.67
1/4	7305X4	420220-131280	5.30
5/16	7305X5	420221-131280	6.74
3/8 x 1/4	7305X6X4	420222-131280	17.04
3/8	7305X6	420223-131280	5.86
1/2 x 3/8	7305X8X6	420224-131280	9.30
1/2	7305X8	420225-131280	8.41
5/8	7305X10	420226-131280	10.85
3/4	7305X12	420227-131280	14.78
7/8	7305X14	420228-131280	22.16
1	7305X16	420229-131280	23.78
1-1/4	7305X20	420230-131280	54.61
1-1/2	7305X24	420231-131280	77.68
2	7305X32	420232-131280	169.85

Large Hex Union

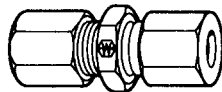

Tube O.D.	Vendor No.	Part No.	Price /Each
1/4	7306X4	420233-131280	\$10.34
3/8	7306X6	420234-131280	13.49
1/2	7306X8	420236-131280	19.61
3/4	7306X12	420237-131280	27.60
1	7306X16	420238-131280	40.08

Bulkhead Union

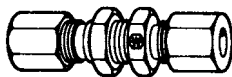

Tube O.D.	Vendor No.	Part No.	Price /Each
1/4	7325X4	420239-131280	\$8.62
3/8	7325X6	420240-131280	10.16
1/2	7325X8	420241-131280	15.39
3/4	7325X12	420242-131280	28.46
1	7325X16	420243-131280	60.74

Male Connector

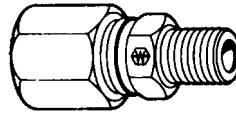

Tube O.D.	MPT	Vendor No.	Part No.	Price /Each
1/8	1/8	7205X2	420244-131280	\$4.08
1/8	1/4	7205X2X4	420245-131280	5.08
3/16	1/8	7205X3	420246-131280	3.64
1/4	1/8	7205X4	420247-131280	3.19
1/4	1/4	7205X4X4	420248-131280	4.15
1/4	3/8	7205X4X6	420249-131280	4.50
1/4	1/2	7205X4X8	420250-131280	6.84
5/16	1/8	7205X5	420251-131280	4.88
5/16	1/4	7205X5X4	420252-131280	5.35
3/8	1/8	7205X6X2	420253-131280	4.38
3/8	1/4	7205X6	420254-131280	3.90
3/8	3/8	7205X6X6	420255-131280	4.69
3/8	1/2	7205X6X8	420256-131280	7.07
1/2	1/4	7205X8X4	420257-131280	6.24
1/2	3/8	7205X8	420258-131280	5.50
1/2	1/2	7205X8X8	420259-131280	6.80
1/2	3/4	7205X8X12	420260-131280	11.10
5/8	3/8	7205X10X6	420261-131280	7.91
5/8	1/2	7205X10	420262-131280	6.84
3/4	1/2	7205X12X8	420263-131280	10.40
3/4	3/4	7205X12	420264-131280	10.18
1	3/4	7205X16X12	420266-131280	16.80
1	1	7205X16	420267-131280	16.10
1-1/4	1-1/4	7205X20	420268-131280	33.29
1-1/2	1-1/2	7205X24	420269-131280	43.09
2	2	7205X32	420270-131280	95.45

Female Connector

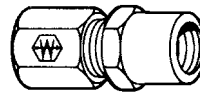

Tube O.D.	FPT	Vendor No.	Part No.	Price /Each
1/8	1/8	7255X2	420271-131280	\$7.36
1/4	1/8	7255X4	420273-131280	3.53
1/4	1/4	7255X4X4	420274-131280	4.64
5/16	1/8	7255X5	420275-131280	4.99
3/8	1/4	7255X6	420276-131280	5.13
3/8	3/8	7255X6X6	420277-131280	6.43
1/2	1/4	7255X8X4	420278-131280	6.89
1/2	3/8	7255X8	420279-131280	6.42
1/2	1/2	7255X8X8	420280-131280	9.24
5/8	1/2	7255X10	420281-131280	9.57
3/4	3/4	7255X12	420282-131280	13.98
7/8	3/4	7255X14	420283-131280	20.30
1	1	7255X16	420284-131280	23.87
1-1/4	1-1/4	7255X20	420285-131280	56.73

Straight Thread O-Ring Connector

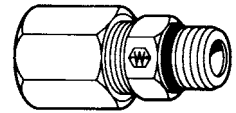

Tube O.D.	Port	Vendor No.	Part No.	Price /Each
3/16	3/16	7315X3	420287-131280	\$10.64
1/4	1/4	7315X4	0420288	4.20
1/4	5/16	7315X4X5	420289-131280	11.50
1/4	3/8	7315X4X6	420290-131280	10.85
5/16	5/16	7315X5	420291-131280	6.23
3/8	3/8	7315X6	420292-131280	4.66
1/2	1/2	7315X8	420294-131280	6.73
1/2	5/8	7315X8X10	420295-131280	9.22
1/2	3/4	7315X8X12	420296-131280	14.25
3/4	3/4	7315X12	420298-131280	11.20
1	3/4	7315X16X12	420301-131280	28.27
1	1	7315X16	420302-131280	17.01
1-1/4	1-1/4	7315X20	420303-131280	41.48
1-1/2	1-1/2	7315X24	420304-131280	47.85

45° Male Elbow

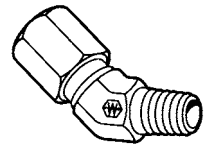

Tube O.D.	MPT	Vendor No.	Part No.	Price /Each
1/4	1/8	7355X4	420306-131280	\$7.34
1/4	1/4	7355X4X4	420307-131280	11.65
3/8	1/4	7355X6	420309-131280	9.16
1/2	3/8	7355X8	420310-131280	11.34
5/8	1/2	7355X10	420311-131280	15.26
3/4	3/4	7355X12	420312-131280	23.94

90° Union Elbow

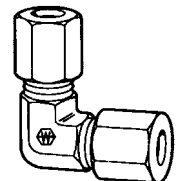

Tube O.D.	Vendor No.	Part No.	Price /Each
1/4	7505X4	420314-131280	\$9.16
5/16	7505X5	420315-131280	10.28
3/8	7505X6	420316-131280	10.57
1/2	7505X8	420317-131280	14.50
5/8	7505X10	420318-131280	17.86
3/4	7505X12	420319-131280	25.13
7/8	7505X14	420320-131280	36.40
1	7505X16	420321-131280	43.81

FLARELESS ERMETO® FITTINGS

Flareless Ermeto® Fittings Cont.

EATON | Weatherhead

Steel Fittings

90° Male Elbow

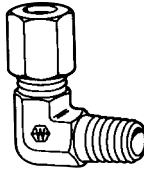

Tube O.D.	MPT	Vendor No.	Part No.	Price /Each
1/8	1/8	7405X2	420323-131280	\$7.52
3/16	1/8	7405X3	420324-131280	7.68
1/4	1/8	7405X4	420325-131280	7.34
1/4	1/4	7405X4X4	420326-131280	8.31
5/16	1/8	7405X5	420327-131280	8.08
5/16	1/4	7405X5X4	420328-131280	9.16
3/8	1/8	7405X6X2	420329-131280	9.23
3/8	1/4	7405X6	420330-131280	8.88
3/8	3/8	7405X6X6	420331-131280	11.31
3/8	1/2	7405X6X8	420332-131280	13.05
1/2	1/4	7405X8X4	420333-131280	12.30
1/2	3/8	7405X8	420334-131280	11.62
1/2	1/2	7405X8X8	420335-131280	15.32
5/8	3/8	7405X10X6	420336-131280	15.39
5/8	1/2	7405X10	420337-131280	14.49
3/4	1/2	7405X12X8	420338-131280	20.25
3/4	3/4	7405X12	420339-131280	20.69
7/8	3/4	7405X14	420340-131280	29.69
1	3/4	7405X16X12	420341-131280	34.68
1	1	7405X16	420342-131280	33.58
1-1/4	1-1/4	7405X20	420343-131280	64.73
1-1/2	1-1/2	7405X24	420344-131280	91.20
2	2	7405X32	420345-131280	189.87

90° Female Elbow

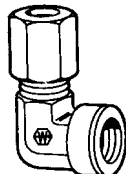

Tube O.D.	FPT	Vendor No.	Part No.	Price /Each
1/4	1/8	7455X4	420346-131280	\$7.81
1/4	1/4	7455X4X4	420347-131280	9.77
3/8	1/4	7455X6	420349-131280	9.98
3/8	3/8	7455X6X6	420350-131280	15.00
1/2	3/8	7455X8	420351-131280	15.71
1/2	1/2	7455X8X8	420352-131280	17.56
5/8	1/2	7455X10	420353-131280	18.28
3/4	3/4	7455X12	420354-131280	27.62
1	1	7455X16	420356-131280	49.31

Straight Thread O-Ring 90° Elbow

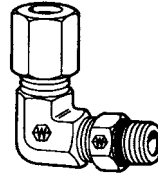

Tube O.D.	Port	Vendor No.	Part No.	Price /Each
1/4	1/4	7515X4	420357-131280	\$9.73
5/16	5/16	7515X5	420358-131280	13.28
3/8	3/8	7515X6	420359-131280	12.68
1/2	1/2	7515X8	420360-131280	15.35
5/8	5/8	7515X10	420361-131280	19.15
3/4	3/4	7515X12	420362-131280	25.89

Union Tee

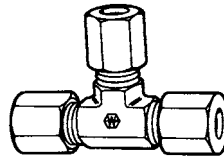

Tube O.D.	Vendor No.	Part No.	Price /Each
3/16	7705X3	420365-131280	\$35.95
1/4	7705X4	420366-131280	14.35
5/16	7705X5	420367-131280	15.16
3/8	7705X6	420368-131280	15.76
1/2	7705X8	420369-131280	20.44
5/8	7705X10	420370-131280	27.27
3/4	7705X12	420371-131280	37.65
7/8	7705X14	420372-131280	66.71

Male Run Tee

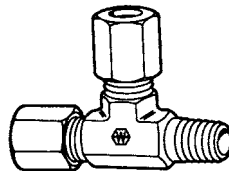

Tube O.D.	MPT	Vendor No.	Part No.	Price /Each
1/4	1/8	7755X4	420374-131280	\$10.19
1/4	1/4	7755X4X4X4	420375-131280	12.99
3/8	1/4	7755X6	420376-131280	13.12
1/2	3/8	7755X8	420377-131280	18.13
1/2	1/2	7755X8X8X8	420378-131280	23.89
5/8	1/2	7755X10	420379-131280	24.89
3/4	3/4	7755X12	420380-131280	34.92

Female Run Tee

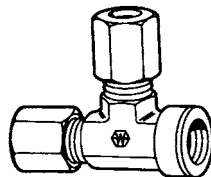

Tube O.D.	FPT	Vendor No.	Part No.	Price /Each
1/4	1/8	7805X4	420382-131280	\$13.69
1/4	1/4	7805X4X4X4	420383-131280	17.07
1/2	3/8	7805X8	420385-131280	22.88
5/8	1/2	7805X10	420386-131280	34.39

Straight Thread O-Ring Run Tee

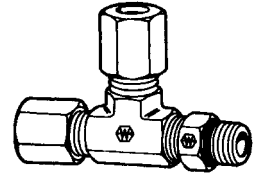

Tube O.D.	Port	Vendor No.	Part No.	Price /Each
1/4	1/4	7716X4	420388-131280	\$23.48
3/8	3/8	7716X6	420389-131280	23.65
1/2	1/2	7716X8	420390-131280	23.80

Male Branch Tee

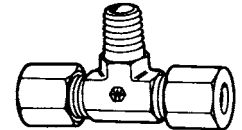

Tube O.D.	MPT	Vendor No.	Part No.	Price /Each
1/4	1/8	7605X4	420391-131280	\$10.73
1/4	1/4	7605X4X4X4	420392-131280	16.60
5/16	1/8	7605X5	420393-131280	21.08
3/8	1/4	7605X6	420394-131280	12.79
1/2	3/8	7605X8	420395-131280	19.76
1/2	1/2	7605X8X8X8	420396-131280	21.24

Female Branch Tee

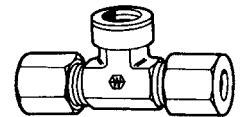

Tube O.D.	FPT	Vendor No.	Part No.	Price /Each
1/4	1/8	7655X4	420400-131280	\$12.87
1/4	1/4	7655X4X4X4	420401-131280	16.49
3/8	1/4	7655X6	420402-131280	15.56
1/2	3/8	7655X8	420403-131280	21.00
5/8	1/2	7655X10	420404-131280	31.13
3/4	3/4	7655X12	420405-131280	40.59
7/8	3/4	7655X14	420406-131280	61.76

Straight Thread O-Ring Branch Tee

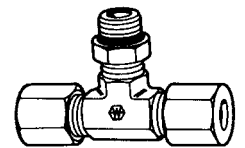

Tube O.D.	Vendor No.	Part No.	Price /Each
1/4 x1/4	7715X4	420409-131280	\$17.66
3/8 x3/8	7715X6	420410-131280	17.86

Cross

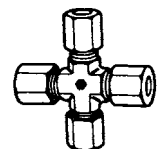

Tube O.D.	Vendor No.	Part No.	Price /Each
1/4	7955X4	420412-131280	\$27.46
3/8	7955X6	420413-131280	35.46

Swivel Adapters



Typical Application: Pressure hydraulic systems.
Pressure: Up to 5,000 psi depending on size.
Sealing Method: Metal to metal, 30° cone-NPSM thread on swivel end.
Material: Carbon steel, AISI/SAE 12L14.
Plating: Zinc, yellow dichromate finish.

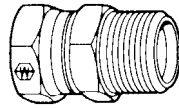

Female Pipe Swivel to Male Pipe

NPSM	MPT	Vendor No.	Weatherhead		Utility	
			Part No.	Price /Each	Part No.	Price /Each
1/8	1/8	9205X2X2	420013-131280	\$2.18	421213	\$1.34
1/8	1/4	9205X2X4	420014-131280	3.50	421214	2.25
1/4	1/8	9205X4X2	420015-131280	3.31	421215	1.71
1/4	1/4	9205X4X4	420016-131280	2.80	421216	1.55
1/4	3/8	9205X4X6	420017-131280	3.60	421217	2.25
1/4	1/2	9205X4X8	420018-131280	6.63	421218	4.54
3/8	1/4	9205X6X4	420019-131280	2.97	421219	2.17
3/8	3/8	9205X6X6	420020-131280	3.90	421220	2.06
3/8	1/2	9205X6X8	420021-131280	4.54	421221	2.95
1/2	3/8	9205X8X6	420022-131280	5.13	421222	2.58
1/2	1/2	9205X8X8	420023-131280	5.08	421223	3.00
1/2	3/4	9205X8X12	420024-131280	6.63	421224	4.12
3/4	1/2	9205X12X8	420025-131280	8.52	421225	4.54
3/4	3/4	9205X12X12	420026-131280	7.42	421226	4.23
3/4	1	9205X12X16	420027-131280	12.71	421227	8.14
1	3/4	9205X16X12	420028-131280	12.33	421228	8.91
1	1	9205X16X16	420029-131280	12.41	421229	7.11
1	1-1/4	9205X16X20	420030-131280	19.02	421230	21.82
1-1/4	1	9205X20X16	420031-131280	21.61	421231	17.74
1-1/4	1-1/4	9205X20X20	420032-131280	19.41	421232	11.08
1-1/2	1-1/2	9205X24X24	420035-131280	29.66	421235	18.03
2	2	9205X32X32	420036-131280	57.76	421236	37.30

Female 37° Swivel to Male Pipe Adapter

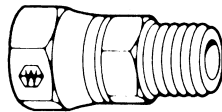

Tube O.D.	MPT	Vendor No.	Weatherhead		Utility	
			Part No.	Price /Each	Part No.	Price /Each
1/4	1/4	9100x4x4	420000-131280	\$6.39	421200	\$3.46
5/16	1/4	9100x5x4	420001-131280	6.88	421201	6.77
3/8	1/4	9100x6x4	420002-131280	6.14	421202	3.64
3/8	3/8	9100x6x6	420003-131280	7.43	421203	4.16
1/2	3/8	9100x8x6	420004-131280	8.76	421204	4.58
1/2	1/2	9100x8x8	420005-131280	8.65	421205	5.22
5/8	3/8	9100x10x6	420006-131280	9.75	421206	10.37
5/8	1/2	9100x10x8	420007-131280	9.91	421207	5.53
3/4	1/2	9100x12x8	420008-131280	12.80	421208	12.55
3/4	3/4	9100x12x12	420009-131280	13.64	421209	11.59
1	3/4	9100x16x12	420010-131280	17.36	421210	19.92
1	1	9100x16x16	420011-131280	15.67	421211	14.42
1-1/4	1-1/4	9100x20x20	420012-131280	28.87	421212	27.19

Female Pipe Swivel to Female Pipe

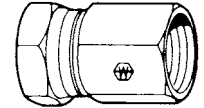

NPSM	FPT	Vendor No.	Weatherhead		Utility	
			Part No.	Price /Each	Part No.	Price /Each
1/8	1/8	9255X2X2	420037-131280	\$1.99	421237	\$1.40
1/4	1/4	9255X4X4	420038-131280	2.91	421238	1.70
1/4	3/8	9255X4X6	420039-131280	4.92	421239	3.53
3/8	1/4	9255X6X4	420040-131280	4.40	421240	2.56
3/8	3/8	9255X6X6	420041-131280	3.91	421241	2.22
3/8	1/2	9255X6X8	420042-131280	6.59	421242	3.41
1/2	3/8	9255X8X6	420043-131280	5.62	421243	3.78
1/2	1/2	9255X8X8	420044-131280	4.76	421244	2.89
3/4	3/4	9255X12X12	420045-131280	6.96	421245	4.33
3/4	1	9255X12X16	420046-131280	19.97	421246	13.32
1	1	9255X16X16	420047-131280	10.77	421247	6.91
1	1-1/4	9255X20X20	420048-131280	18.92	421248	11.46
1-1/2	1-1/2	9255X24X24	420049-131280	29.98	421249	20.55
2	2	9255X32X32	420050-131280	63.16	421250	35.19

Female Pipe Swivel to Male Pipe 45° Elbow

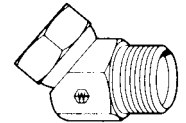

NPSM	MPT	Vendor No.	Weatherhead		Utility	
			Part No.	Price /Each	Part No.	Price /Each
1/8	1/8	9355X2X2	420051-131280	\$4.45	421251	\$2.58
1/4	1/8	9355X4X2	420052-131280	8.06	421252	6.56
1/4	1/4	9355X4X4	420053-131280	5.51	421253	3.04
1/4	3/8	9355X4X6	420054-131280	7.79	421254	5.36
1/4	1/2	9355X4X8	420055-131280	15.53	421255	10.54
3/8	1/4	9355X6X4	420056-131280	9.55	421256	10.14
3/8	3/8	9355X6X6	420057-131280	6.74	421257	3.82
3/8	1/2	9355X6X8	420058-131280	9.77	421258	5.45
1/2	3/8	9355X8X6	420059-131280	11.12	421259	10.14
1/2	1/2	9355X8X8	420060-131280	8.13	421260	5.05
1/2	3/4	9355X8X12	420061-131280	14.63	421261	10.77
3/4	1/2	9355X12X8	420062-131280	24.13	421262	15.46
3/4	3/4	9355X12X12	420063-131280	12.42	421263	7.21
3/4	1	9355X12X16	420064-131280	26.67	421264	18.87
1	3/4	9355X16X12	420065-131280	29.24	421265	21.81
1	1	9355X16X16	420066-131280	19.46	421266	12.36
1	1-1/4	9355X16X20	420067-131280	35.84	421267	26.62
1-1/4	1-1/4	9355X20X20	420068-131280	37.65	421268	26.61

SWIVEL ADAPTERS

Swivel Adapters

EAT-N | Weatherhead

Female Pipe Swivel to Male Pipe 90° Elbow

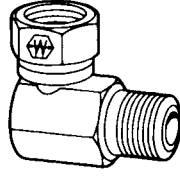

NPSM	MPT	Vendor No.	Weatherhead		Utility	
			Part No.	Price /Each	Part No.	Price /Each
1/8	1/8	9405X2X2	420071-131280	\$4.29	421271	\$2.56
1/8	1/4	9405X2X4	420072-131280	5.52	421272	3.95
1/4	1/8	9405X4X2	420073-131280	5.59	421273	4.01
1/4	1/4	9405X4X4	420074-131280	4.80	421274	2.85
1/4	3/8	9405X4X6	420075-131280	5.80	421275	3.61
1/4	1/2	9405X4X8	420076-131280	9.23	421276	5.16
3/8	1/4	9405X6X4	420077-131280	6.88	421277	4.18
3/8	3/8	9405X6X6	420078-131280	6.41	421278	3.61
3/8	1/2	9405X6X8	420079-131280	7.79	421279	4.23
3/8	3/4	9405X6X12	420080-131280	13.62	421280	9.15
1/2	3/8	9405X8X6	420081-131280	8.33	421281	4.74
1/2	1/2	9405X8X8	420082-131280	8.53	421282	4.38
1/2	3/4	9405X8X12	420083-131280	12.83	421283	7.56
1/2	1	9405X8X16	420084-131280	26.04	421284	23.44
3/4	3/4	9405X12X12	420085-131280	14.20	421285	7.37
3/4	1	9405X12X16	420086-131280	21.57	421286	16.09
1	3/4	9405X16X12	420087-131280	23.04	421287	17.60
1	1	9405X16X16	420088-131280	22.82	421288	15.27
1-1/4	1-1/4	9405X20X20	420091-131280	39.85		
1-1/2	1-1/2	9405X24X24	420093-131280	56.30		
2	2	9405X32X32	420094-131280	163.82		

Female Pipe Swivel to Female Pipe 90° Elbow

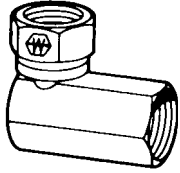

NPSM	FPT	Vendor No.	Weatherhead		Utility	
			Part No.	Price /Each	Part No.	Price /Each
1/8	1/8	9455X2X2	420095-131280	\$4.39	421295	\$2.58
1/4	1/4	9455X4X4	420096-131280	5.48	421296	2.84
1/4	3/8	9455X4X6	420097-131280	7.67	421297	5.11
1/4	1/2	9455X4X8	420098-131280	13.55	421298	13.03
3/8	1/4	9455X6X4	420099-131280	13.40	421299	9.70
3/8	3/8	9455X6X6	420100-131280	6.63	421300	3.71
3/8	1/2	9455X6X8	420101-131280	8.73	421301	6.30
1/2	3/8	9455X8X6	420102-131280	10.26	421302	7.66
1/2	1/2	9455X8X8	420103-131280	8.12	421303	5.15
1/2	3/4	9455X8X12	420104-131280	14.01	421304	9.06
3/4	1/2	9455X12X8	420105-131280	31.80	421305	29.50
3/4	3/4	9455X12X12	420106-131280	12.78	421306	7.47
3/4	1	9455X12X16	420107-131280	25.95	421307	18.73
1	3/4	9455X16X12	420108-131280	58.48	421308	54.87
1	1	9455X16X16	420109-131280	21.95	421309	15.20
1-1/4	1-1/4	9455X20X20	420110-131280	42.43		
1-1/2	1-1/2	9455X24X24	420111-131280	93.58		
2	2	9455X32X32	420112-131280	233.92		

Male Straight Thread to Female Pipe Swivel Straight

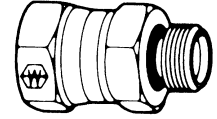

Thread	NPSM	Vendor No.	Weatherhead		Utility	
			Part No.	Price /Each	Part No.	Price /Each
7/16 Straight	1/4	9315X4X4	420524-131280	\$2.97	421809	\$1.81
7/16 Straight	3/8	9315X4X6	420525-131280	5.12	421810	7.61
1/2 Straight	1/4	9315X5X4	420526-131280	5.79	421811	4.01
9/16 Straight	1/4	315X6X4	420527-131280	4.00	421812	1.97
9/16 Straight	3/8	9315X6X6	420528-131280	4.12	421813	2.09
9/16 Straight	1/2	9315X6X8	420529-131280	6.59	421814	4.76
3/4 Straight	1/4	9315X8X4	420530-131280	4.87	421815	3.22
3/4 Straight	3/8	9315X8X6	420531-131280	4.01	421816	2.67
3/4 Straight	1/2	9315X8X8	420532-131280	4.43	421817	2.71
3/4 Straight	3/4	9315X8X12	420533-131280	9.14	421818	6.20
7/8 Straight	3/8	9315X10X6	420534-131280	5.88	421819	3.71
7/8 Straight	1/2	9315X10X8	420535-131280	5.12	421820	3.48
7/8 Straight	3/4	9315X10X12	420536-131280	7.33	421821	4.91
1-1/16 Straight	1/2	9315X12X8	420537-131280	7.81	421822	5.73
1-1/16 Straight	3/4	9315X12X12	420538-131280	8.42	421823	4.64
1-3/16 Straight	3/4	9315X14X12	420539-131280	18.96	421824	13.04
1-5/16 Straight	3/4	9315X16X12	420540-131280	15.30	421825	9.49
1-5/16 Straight	1	9315X16X16	420541-131280	14.27	421826	8.55
1-5/8 Straight	1-1/4	9315X20X20	420543-131280	33.63		

Female Pipe Swivel to Female Pipe 45° Elbow

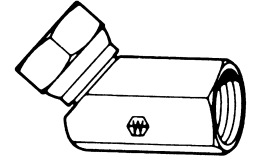

NPSM	FPT	Vendor No.	Part No.	Price /Each
1/4	1/4	9385X4X4	420556-131280	\$7.68
3/8	3/8	9385X6X6	420558-131280	9.88
1/2	1/2	9385X8X8	420560-131280	10.05
3/4	3/4	9385X12X12	420561-131280	15.00
1	1	9385X16X16	420563-131280	25.61
1-1/4	1-1/4	9385X20X20	420564-131280	52.65
1-1/2	1-1/2	9385X24X24	420565-131280	76.04

Female 45° Flare Swivel to Male SAE 45° Elbow

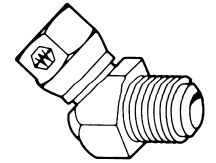

Tube O.D.	Vendor No.	Part No.	Price /Each
3/8	9154X6X6	420567-131280	\$7.89
1/2	9154X8X8	420568-131280	9.94
5/8	9154X10X10	420569-131280	11.71

Swivel Adapters Cont.



Male Straight Thread to Female Pipe Swivel 45° Elbow

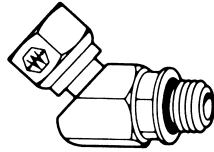

Thread	NPSM	Vendor No.	Part No.	Price /Each
7/16 Straight	1/4	9365X4X4	420570-131280	\$10.63
7/16 Straight	3/8	9365X4X6	420571-131280	11.42
9/16 Straight	3/8	9365X6X6	420572-131280	10.98
9/16 Straight	1/2	9365X6X8	420573-131280	16.84
3/4 Straight	3/8	9365X8X6	420574-131280	13.76
3/4 Straight	1/2	9365X8X8	420575-131280	12.46
7/8 Straight	1/2	9365X10X8	420576-131280	13.42
1-1/16 Straight	3/4	9365X12X12	420577-131280	20.11
1-5/16 Straight	1	9365X16X16	420578-131280	38.00

90° Elbow 45° Female Swivel to SAE 45°

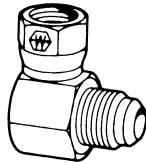

Tube O.D.	Vendor No.	Part No.	Price /Each
3/8	9151X6X6	420581-131280	\$6.86
1/2	9151X8X8	420582-131280	7.25
5/8	9151X10X10	420583-131280	11.70

Male Pipe Swivel to Male Pipe Rigid 90° Elbow

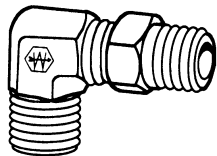

Swivel End	MPT	Vendor No.	Part No.	Price /Each
1/4	1/4	9435X4X4	420604-131280	\$12.85
3/8	3/8	9435X6X6	420605-131280	13.64
1/2	1/2	9435X8X8	420606-131280	18.45

Male Straight Thread to Female Pipe Swivel 90° Elbow

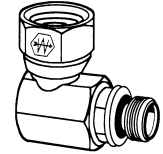

Thread	NPSM	Vendor No.	Weatherhead		Utility	
			Part No.	Price /Each	Part No.	Price /Each
7/16 Straight	1/4	9515X4X4	420584-131280	\$7.30	421860	\$5.15
7/16 Straight	3/8	9515X4X6	420585-131280	7.68	421861	11.95
9/16 Straight	1/4	9515X6X4	420586-131280	8.13	421862	4.76
9/16 Straight	3/8	9515X6X6	420587-131280	8.04	421863	5.61
9/16 Straight	1/2	9515X6X8	420588-131280	12.80	421864	8.97
3/4 Straight	3/8	9515X8X6	420589-131280	11.61	421865	7.49
3/4 Straight	1/2	9515X8X8	420590-131280	11.35	421866	7.73
3/4 Straight	3/4	9515X8X12	420591-131280	17.56	421867	11.85
7/8 Straight	3/8	9515X10X6	420592-131280	11.34	421868	8.33
7/8 Straight	1/2	9515X10X8	420593-131280	11.63	421869	7.76
7/8 Straight	3/4	9515X10X12	420594-131280	19.77	421870	16.24
1-1/16 Straight	1/2	9515X12X8	420595-131280	17.43	421871	12.21
1-1/16 Straight	3/4	9515X12X12	420596-131280	17.29	421872	12.75
1-5/16 Straight	3/4	9515X16X12	420598-131280	30.72		
1-5/16 Straight	1	9515X16X16	420599-131280	27.05		
1-5/8 Straight	1-1/4	9515X20X20	420601-131280	62.91		

Female Pipe Swivel to Male Pipe 90° Elbow - Long

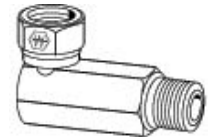

NPSM	MPT	Vendor No.	Part No.	Price /Each
1/8	1/8	9405X2X2LL	0445649	\$6.14
1/4	1/4	9405X4X4LL	0445650	8.07
3/8	3/8	9405X6X6LL	0445651	9.14
1/2	1/2	9405X8X8LL	0445652	13.02
3/4	3/4	9405X12X12LL	0445647	18.64

Female Pipe Swivel Tee

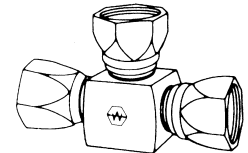

NPSM	Vendor No.	Part No.	Price /Each
1/4	9705X4X4X4	420608-131280	\$11.00
3/8	9705X6X6X6	420609-131280	12.00
1/2	9705X8X8X8	420610-131280	16.80

Female Pipe Swivel to Female Pipe Branch Tee

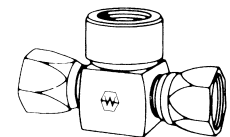

NPSM	FPT	Vendor No.	Part No.	Price /Each
1/4		9456X4X4X4	420629-131280	\$11.70
3/8		9456X6X6X6	420631-131280	10.11
1/2		9456X8X8X8	420633-131280	13.75

SWIVEL & STAINLESS STEEL ADAPTERS & HOSE

Swivel Adapters Cont.

EATON | Weatherhead

Female Pipe Swivel to Male Pipe Branch Tee

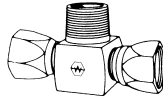

NPSM	MPT	Vendor No.	Part No.	Price /Each
1/8	1/8	9406X2X2X2	420614-131280	\$9.08
1/4	1/4	9406X4X4X4	420615-131280	8.05
1/4	3/8	9406X4X4X6	420616-131280	11.35
3/8	3/8	9406X6X6X6	420618-131280	10.63
3/8	1/2	9406X6X6X8	420619-131280	13.54
1/2	1/2	9406X8X8X8	420620-131280	13.88

Stainless Steel Adapter Unions

Male Adapter Union

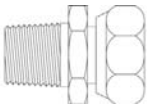

NPTF	NPSM	Part No.	Price /Each
1/8	1/8	425891	\$43.35
1/8	1/4	425892	85.55
1/4	1/4	425894	27.86
1/4	3/8	425895	91.90
3/8	3/8	425898	40.60
1/2	1/2	425902	51.42
3/4	3/4	425905	63.20
1	1	425908	110.94
1-1/2	1-1/2	425912	267.58

O.R.B. Connector

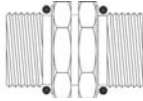

Port Size	Part No.	Price /Each
1/4	425969	\$46.15
3/8	425970	67.81
1/2	425971	85.93
1	425975	123.83

Straight Connector

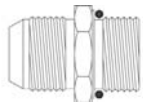

Tube O.D.	Port	Part No.	Price /Each
1/4	1/8	425981	\$48.90
1/4	1/4	425982	5.47
1/4	3/8	425984	8.69
1/4	1/2	425985	34.55
3/8	1/4	425987	30.40
3/8	3/8	425989	7.03
3/8	1/2	425990	13.74
1/2	3/8	425993	39.96
1/2	1/2	425994	9.59
1/2	5/8	425995	18.60
5/8	5/8	426000	58.99
3/4	1/2	426002	83.29
3/4	3/4	426004	36.02
1	1/2	426006	97.44
1	3/4	426008	87.79
1	1	426009	54.05
1-1/4	1	426012	144.67
1-1/4	1-1/4	426013	91.17
1-1/4	1-1/4	426015	197.53

O.R.B. Swivel Adapter

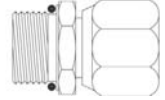

Port	Tube O.D.	Part No.	Price /Each
3/8	3/8	426038	\$136.07
1/2	1/2	426039	175.66

General Purpose Low Pressure Hydraulic Hoses

EATON | Weatherhead

*** ALL STARRED ITEMS ARE BULK QUANTITIES ***

H009 General Purpose Hose SAE 100R6

- SAE J1942/1. Qualified for marine applications Hyd. service. -05, -06 and -08 with E-Series or 009 B-Series
- MSHA Accepted.
- **Typical Application:** General-purpose air, oil and water lines. Low pressure Hydraulic
- **Inner Tube:** Nitrile
- **Reinforcement:** 1 Fiber Braid
- **Cover:** Neoprene
- **Temperature Range:** -40°F to +212°F (-40°C to +100°C)
- **Color:** Black
- **Hose Ends:** Coll-O-Crimp®
E-Series for 5-8 Sizes; Field Attachable 009 B-Series



Specifications

Vendor No.	Hose I.D.	Hose O.D.	Work Pressure (PSI)	Min. Burst Pressure (PSI)	Min. Bend Radii	Wt./100 (ft)	Length
H00904	1/4	1/2	400	1600	2- 21/2	10	25', 50', 250'
H00905	5/16	9/16	400	1600	3	12	25', 50', 250'
H00906	3/8	5/8	400	1600	3	14	25', 50', 250'
H00908	1/2	25/32	400	1600	4	20	50', 250'

Fastenal Branch Personnel: Please Sold Request number of feet when ordering.

Part No.	Vendor No.	Hose I.D.	Price /Ft
400133-131280	H00904-25	1/4	\$2.60
400134-131280	H00904-50	1/4	2.60
400135-131280	H00904-250	*1/4	2.07
400136-131280	H00905-25	5/16	2.95
400137-131280	H00905-50	5/16	2.90
400138-131280	H00905-250	*5/16	2.30
400139-131280	H00906-25	3/8	3.40
400140-131280	H00906-50	3/8	3.15
400141-131280	H00906-250	*3/8	2.52
400142-131280	H00908-50	1/2	4.33
400143-131280	H00908-250	*1/2	3.58

GENERAL PURPOSE HYDRAULIC HOSE

General Purpose Low Pressure Hydraulic Hose Cont.

EATON | Weatherhead

H201 General Purpose Hose (Push-On)

- MSHA Accepted (Black only)
- **Typical Application:** General-purpose low-pressure air, oil and water lines.
- **Inner Tube:** Nitrile
- **Reinforcement:** 1 Fiber Braid
- **Cover:** Neoprene (Black), Vinyl Nitrile (Colored Hoses)
- **Temperature Range:** -40°F to +212°F (-40°C to +100°C)
- **Cover Color Available Through Warehouse:** Black, Blue, Red.
- **Cover Color on Special Orders:** Gray, Yellow, Green.
- **Hose Ends:** Field Attachable 100 B-Series Barb-Tite



Specifications

Vendor No.	Hose I.D.	Hose O.D.	Work Pressure (PSI)	Min. Burst Pressure (PSI)	Min. Bend Radii	Wt./100 (ft)	Length
H20104	1/4	1/2	250	1000	3	9	50', 250', 500'
H20106	3/8	5/8	250	1000	3	13	50', 250', 500'
H20108	1/2	3/4	250	1000	5	15	50', 250', 500'
H20110	5/8	29/32	250	1000	6	23	250'
H20112	3/4	1-1/32	250	1000	7	26	250'

Fastenal Branch Personnel: Please Sold Request number of feet when ordering.

Part No.	Vendor No.	Hose I.D.	Price /Ft
400063-131280	H20104BK-50	1/4	\$1.32
400064-131280	H20104BK-250	1/4	1.22
400065-131280	H20104BK-500	*1/4	1.18
400066-131280	H20106BK-50	3/8	1.61
400068-131280	H20106BK-500	*3/8	1.48
400069-131280	H20108BK-50	1/2	1.81
400070-131280	H20108BK-250	1/2	1.60
400071-131280	H20108BK-500	*1/2	1.75
400072-131280	H20110BK-250	*5/8	2.67
400073-131280	H20112BK-250	*3/4	2.95
0400600	H20104BU-250R	1/4	1.22
0400601	H20106BU-250R	3/8	1.55
0400602	H20108BU-250R	1/2	1.60
0400603	H20104RD-250R	1/4	1.22
0400604	H20106RD-250R	3/8	1.55
0400605	H20108RD-250R	1/2	1.60
0400606	H20110BU-250R	5/8	2.67
0400607	H20110RD-250R	5/8	2.67
0400608	H20112BU-250R	3/4	2.95
0400609	H20112RD-250R	3/4	2.95

H100 General Purpose Hose Fabric Cover

- **Typical Application:** General-purpose low-pressure air, fuel, diesel fuel, oil and water lines.
- **Inner Tube:** Nitrile
- **Reinforcement:** 1 Fiber Braid
- **Cover:** Fiber Braid
- **Temperature Range:** -40°F to +212°F (-40°C to +100°C)
- **Hose Ends:** Field Attachable 100 B-Series Barb-Tite



Specifications

Vendor No.	Hose I.D.	Hose O.D.	Work Pressure (PSI)	Min. Burst Pressure (PSI)	Min. Bend Radii	Wt./100 (ft)	Length
H10004	1/4	1/2	350	1400	3	7	50', 250'
H10005	5/16	9/16	350	1400	3	9	50', 250'
H10006	3/8	5/8	350	1400	3	11	50', 250'
H10008	1/2	3/4	350	1400	5	14	50', 250'
H10010	5/8	29/32	350	1400	6	16	50', 250'
H10012	3/4	1-1/32	350	1400	7	18	50', 250'

Fastenal Branch Personnel: Please Sold Request number of feet when ordering.

Part No.	Vendor No.	Hose I.D.	Price /Ft
400074-131280	H10004-50	1/4	\$2.85
400075-131280	H10004-250	*1/4	2.45
400076-131280	H10005-50	5/16	4.18
400077-131280	H10005-250	*5/16	3.12
400078-131280	H10006-50	3/8	2.73
400079-131280	H10006-250	*3/8	2.60
400080-131280	H10008-50	1/2	3.35
400081-131280	H10008-250	*1/2	3.25
400082-131280	H10010-50	5/8	4.35
400083-131280	H10010-250	*5/8	4.10
400084-131280	H10012-50	3/4	6.43
400085-131280	H10012-250	*3/4	5.58

H101 General Purpose Hose Rubber Cover

- MSHA Accepted (Black only)
- **Typical Application:** General-purpose low-pressure air, oil and water lines.
- **Inner Tube:** Nitrile
- **Reinforcement:** 1 Fiber Braid
- **Cover:** Neoprene
- **Temperature Range:** -40°F to +212°F (-40°C to +100°C)
- **Hose Ends:** Field Attachable 100 B-Series Barb-Tite



Specifications

Vendor No.	Hose I.D.	Hose O.D.	Work Pressure (PSI)	Min. Burst Pressure (PSI)	Min. Bend Radii	Wt./100 (ft)	Length
H10104	1/4	1/2	350	1400	3	9	50', 250'
H10105	5/16	9/16	350	1400	3	11	50', 250'
H10106	3/8	5/8	350	1400	3	13	50', 250'
H10108	1/2	3/4	350	1400	5	15	50', 250'
H10110	5/8	29/32	350	1400	6	23	50', 250'
H10112	3/4	1-1/32	350	1400	7	26	50', 250'

Fastenal Branch Personnel: Please Sold Request number of feet when ordering.

Part No.	Vendor No.	Hose I.D.	Price /Ft
400086-131280	H10104-50	1/4	\$2.10
400087-131280	H10104-250	*1/4	2.03
400088-131280	H10105-50	5/16	2.20
400089-131280	H10105-250	*5/16	2.13
400090-131280	H10106-50	3/8	2.27
400091-131280	H10106-250	*3/8	2.15
400092-131280	H10108-50	1/2	2.35
400093-131280	H10108-250	*1/2	2.23
400094-131280	H10110-50	5/8	3.35
400095-131280	H10110-250	*5/8	3.23
400096-131280	H10112-50	3/4	4.45
400097-131280	H10112-250	*3/4	4.25

Hydraulic Hose

GENERAL PURPOSE HYDRAULIC HOSE

General Purpose Low Pressure Hydraulic Hose Cont.

Hydraulic Hose

EATON | Weatherhead

H209 General Purpose Hose

- **Typical Application:** General hydraulic and pneumatic service; high-temperature industrial cleaning and car wash applications.
- **Inner Tube:** Nylon 11
- **Reinforcement:** 1 Fiber Braid
- **Cover:** Polyurethane
- **Cover Color:** Black
- **Temperature Range:** -40°F to +200°F (-40°C to +93°C)
- **Hose Ends:** Coll-O-Crimp® E-Series



Specifications

Vendor No.	Hose I.D.	Hose O.D.	Work Pressure (PSI)	Min. Burst Pressure (PSI)	Min. Bend Radii	Wt./100 (ft)	Length
H20904	1/4	29/64	2250	9000	1-1/2	5	500'
H20906	3/8	9/16	1350	5400	2-1/2	7	250'
H20908	1/2	45/64	1000	4000	3-1/2	9	250'

Fastenal Branch Personnel: Please Sold Request number of feet when ordering.

Vendor Part No.	No.	Hose I.D.	Price /Ft
400190-131280	H20904-500	*1/4	\$1.78
400192-131280	H20906-250	*3/8	2.26
400193-131280	H20908-250	*1/2	2.63

H105 General Purpose Hose

Air/Water

- **Typical Application:** Air and water applications where petroleum contact is limited; some agricultural solutions
- **Inner Tube:** EPDM
- **Reinforcement:** Multi-Fiber Spiral
- **Cover:** EPDM
- **Color Cover:** Red
- **Temperature Range:** Air: +32°F to +160°F (0°C to +71°C) Water: -40°F to +180°F (-40°C to +82°C)
- **Hose Ends:** Coll-O-Crimp® U-Series; Field Attachable 057 B-Series; 105 B-Series

*When used with U-Series only

**When used with 105B and 057B Series only



Specifications

Vendor No.	Hose I.D.	Hose O.D.	Work Pressure (PSI)	Min. Burst Pressure (PSI)	Min. Bend Radii	Wt./100 (ft)	Length
H10504	1/4	5/8	300*, 175**	1200*, 700**	3	13	50', 600'
H10506	3/8	3/4	300*, 175**	1200*, 700**	3-1/2	18	50', 600'
H10508	1/2	7/8	300*, 150**	1200*, 600**	4-1/2	23	50', 600'
H10512	3/4	1-3/16	300*, 150**	1200*, 600**	5-3/4	37	50', 600'
H10516	1	1-7/16	200*	800	7-1/4	64	50', 300'

Fastenal Branch Personnel: Please Sold Request number of feet when ordering.

Part No.	Vendor No.	Hose I.D.	Price /Ft
400098-131280	H10504-50	1/4	\$0.78
400099-131280	H10504-600	*1/4	0.66
400100-131280	H10506-50	3/8	0.96
400101-131280	H10506-600	*3/8	0.87
400102-131280	H10508-50	1/2	1.21
400103-131280	H10508-600	*1/2	0.98
400104-131280	H10512-50	3/4	1.41
400105-131280	H10512-600	*3/4	1.10
400106-131280	H10516-50	1	2.23
400107-131280	H10516-300	*1	1.81

H115 Oil-Resistant General Purpose Hose

Air/Water

- **Typical Application:** Oily air systems, water. Ideal for pneumatic tool operation.
- **Inner Tube:** Nitrile
- **Reinforcement:** Multi-Fiber Braid
- **Cover:** Nitrile Blend
- **Cover Color:** Red
- **Temperature Range:** -40°F to +160°F (-40°C to +71°C)
- **Hose Ends:** Coll-O-Crimp® U-Series except 5 and 24 Sizes; Field Attachable 057 B-Series; 105 B-Series



Specifications

Vendor No.	Hose I.D.	Hose O.D.	Work Pressure (PSI)	Min. Burst Pressure (PSI)	Min. Bend Radii	Wt./100 (ft)	Length
H11504	1/4	19/32	300	1200	3	15	50', 550'
H11505	5/16	21/32	300	1200	3-1/2	17	50', 550'
H11506	3/8	23/32	300	1200	3-1/2	19	50', 550'
H11508	1/2	7/8	300	1200	4-1/2	27	50', 550'
H11512	3/4	1-5/32	300	1200	5-3/4	41	50', 550'
H11516	1	1-7/16	300	1200	7-1/4	62	50', 300'
H11520	1-1/4	1-3/4	225	900	8-3/4	101	50', 300'
H11524	1-1/2	2	225	900	10	106	50', 300'

Fastenal Branch Personnel: Please Sold Request number of feet when ordering.

Part No.	Vendor No.	Hose I.D.	Price /Ft
400108-131280	H11504-50	1/4	\$1.13
400109-131280	H11504-550	*1/4	1.03
400110-131280	H11505-50	5/16	1.25
400111-131280	H11505-550	*5/16	1.08
400112-131280	H11506-50	3/8	1.58
400113-131280	H11506-550	*3/8	1.40
400114-131280	H11508-50	1/2	1.87
400115-131280	H11508-550	*1/2	1.70
400118-131280	H11512-50	3/4	2.63
400119-131280	H11512-550	*3/4	2.30
400120-131280	H11516-50	1	4.05
400121-131280	H11516-300	*1	3.50
400122-131280	H11520-50	1-1/4	5.90
400123-131280	H11520-300	*1-1/4	5.28
400124-131280	H11524-50	1-1/2	6.85
400125-131280	H11524-300	*1-1/2	6.10

GENERAL PURPOSE HYDRAULIC HOSE

General Purpose Low Pressure Hydraulic Hose Cont.

EAT•N | Weatherhead

H039 Suction Hose SAE 100R4

- Marine Application J1942/1 - Hydraulic only.
- MSHA Accepted
- **Typical Application:** Hydraulic Suction Hose
- **Inner Tube:** Nitrile Blend
- **Reinforcement:** 3/4" - 1-1/2" 1 helical cabled wire and 1 fiber braid 2" - 1 helical, single-stranded wire and 1 fiber braid
- **Cover:** Neoprene
- **Temperature Range:** -40°F to +212°F (-40°C to +100°C)
- **Hose Ends:** Coll-O-Crimp® U-Series for 2-20 Sizes; Coll-O-Crimp® S-Series for 12-20 Sizes; 430 U-Series for 24 & 32 Sizes; Field Attachable K-Series; 039 K-Series; 430 E-Series for 24 and 32 Sizes.



Specifications

Vendor No.	Hose I.D.	Hose O.D.	Work Pressure (PSI)	Min. Burst Pressure (PSI)	Min. Bend Radii	Inch Merc. Vacuum	Wt/100 (ft)	Length
H03912	3/4	1-3/8	300	1200	5	25	44	50', 150'
H03916	1	1-5/8	250	1000	6	25	66	50', 150'
H03920	1-1/4	1-25/32	200	800	8	25	79	150'
H03924	1-1/2	2-5/64	150	600	10	25	96	50', 100'
H03932	2	2-1/2	100	400	12	25	130	100'

Fastenal Branch Personnel: Please Sold Request number of feet when ordering.

Part No.	Vendor No.	Hose I.D.	Price /Ft
400126-131280	H03912-50	3/4	\$6.68
0401102	H03912-150	*3/4	6.39
400127-131280	H03916-50	1	8.85
0446942	H03916-150	*1	8.73
400128-131280	H03920-150	*1-1/4	10.88
400129-131280	H03924-50	1-1/2	15.40
0446943	H03924-100	*1-1/2	15.18
400130-131280	H03932-100	*2	16.90

Medium Pressure Hydraulic Hose

EAT•N | Weatherhead

*** ALL STARRED ITEMS ARE BULK QUANTITIES ***

H435 Non-Conductive Hose SAE 100R7

- **Typical Application:** Compatible with most hydraulic fluids, designed for use where electric shock hazards exist. Maximum leakage is 50 Micro Amperes per foot at 75 KV per foot for five minutes.
- **Inner Tube:** Nylon 11
- **Reinforcement:** 2 Fiber Braids
- **Cover:** Non-Conductive Polyurethane
- **Cover Color:** Orange
- **Temperature Range:** -40°F to +200°F (-40°C to +93°C)
- **Hose Ends:** Coll-O-Crimp® E-Series; Field Attachable 436 N-Series



Specifications

Vendor No.	Hose I.D.	Hose O.D.	Work Pressure (PSI)	Min. Burst Pressure (PSI)	Min. Bend Radii	Wt/100 (ft)	Length
H43504	1/4	29/64	2750	11000	1	5	50', 500'
H43505	5/16	9/16	2500	10000	1-1/2	7	50', 500'
H43506	3/8	5/8	2250	9000	2	8	50', 250'
H43508	1/2	13/16	2000	8000	2-1/2	12	50', 250'
H43512	3/4	1-1/16	1250	5000	9-1/2	19	50'
H43516	1	1-3/8	1000	4000	12	25	50'

Fastenal Branch Personnel: Please Sold Request number of feet when ordering.

Part No.	Vendor No.	Hose I.D.	Price /Ft
400257-131280	H43504-50	1/4	\$2.81
400258-131280	H43504-500	*1/4	2.04
400259-131280	H43505-50	5/16	2.98
400260-131280	H43505-500	*5/16	2.24
400261-131280	H43506-50	3/8	4.10
400262-131280	H43506-250	*3/8	3.32
400263-131280	H43508-50	1/2	3.05
400264-131280	H43508-250	*1/2	2.85
400265-131280	H43512-50	*3/4	6.60
400266-131280	H43516-50	*1	9.30

H435 Twin Line Non-Conductive Hose SAE 100R7 - Multi-Tube

- **Typical Application:** Compatible with most hydraulic fluids, designed for use where electric shock hazards exist. Maximum leakage is 50 Micro Amperes per foot at 75 KV per foot for five minutes.
- **Inner Tube:** Nylon 11
- **Reinforcement:** 2 Fiber Braids
- **Cover:** Non-Conductive Polyurethane
- **Cover Color:** Orange
- **Temperature Range:** -40°F to +200°F (-40°C to +93°C)
- **Hose Ends:** Coll-O-Crimp® E-Series; Field Attachable 436 N-Series



Specifications

Vendor No.	Hose I.D.	Hose O.D.	Work Pressure (PSI)	Min. Burst Pressure (PSI)	Min. Bend Radii	Wt/100 (ft)	Length
H43566	3/8, 3/8	5/8, 5/8	2,250	9,000	2	16	50', 250'
H43588	1/2, 1/2	13/16, 13/16	2,000	8,000	2-1/2	24	50', 250'

Fastenal Branch Personnel: Please Sold Request number of feet when ordering.

Part No.	Vendor No.	Hose I.D.	Price /Ft
400280-131280	H43566-250	*3/8, 3/8	\$5.70
400284-131280	H43588-250	*1/2, 1/2	8.78

Hydraulic Hose

MEDIUM PRESSURE HYDRAULIC HOSES

Medium Pressure Hydraulic Hose Cont.

EATON | Weatherhead

H017 Hydraulic Hose SAE100R3

- Marine application J1942/1 - Hydraulic only.
- MSHA Accepted
- **Typical Application:** Medium pressure fuel and oil lines, hydraulic return lines
- **Inner Tube:** Nitrile
- **Reinforcement:** 2 Fiber Braids
- **Cover:** Neoprene
- **Temperature Range:** -40°F to +212°F (-40°C to +100°C)
- **Hose Ends:** Coll-O-Crimp® U-Series



Specifications

Vendor No.	Hose I.D.	Hose O.D.	Work Pressure (PSI)	Min. Burst Pressure (PSI)	Min. Bend Radii	Wt/100 (ft)	Length
H01704	1/4	9/16	1250	5000	3	13	50', 250'
H01706	3/8	3/4	1125	4500	4	22	50', 250'
H01708	1/2	15/16	1000	4000	5	28	50', 250'
H01712	3/4	1-1/4	750	3000	6	43	50', 250'
H01716	1	1-1/2	565	2250	8	64	50', 250'
H01720	1-1/4	1-3/4	375	1500	10	80	50', 100'

Fastenal Branch Personnel: Please Sold Request number of feet when ordering.

Part No.	Vendor No.	Hose I.D.	Price /Ft
400169-131280	H01704-50	1/4	\$2.80
400170-131280	H01704-250	*1/4	2.78
400171-131280	H01706-50	3/8	3.81
400172-131280	H01706-250	*3/8	3.76
400173-131280	H01708-50	1/2	6.13
400174-131280	H01708-250	*1/2	5.45
400175-131280	H01712-50	3/4	8.28
400176-131280	H01712-250	*3/4	8.13
400177-131280	H01716-50	1	12.15
400178-131280	H01716-250	*1	11.03
400179-131280	H01720-50	*1-1/4	12.25

H436 Perforated Cover Hose SAE 100R7

- **Typical Application:** In addition to its compatibility with most hydraulic fluids, the low effusion rate of this hose makes it ideally suited for carbon dioxide and nitrogen. Perforated cover permits breathing, eliminating condensation and blistering.
- **Inner Tube:** Nylon 11
- **Reinforcement:** 2 Fiber Braids
- **Braids Cover:** Polyurethane (Perforated)
- **Cover Color:** Black
- **Temperature Range:** -40°F to +200°F (-40°C to +93°C)
- **Hose Ends:** Coll-O-Crimp® E-Series; Field Attachable 436 N-Series



Specifications

Vendor No.	Hose I.D.	Hose O.D.	Work Pressure (PSI)	Min. Burst Pressure (PSI)	Min. Bend Radii	Wt/100 (ft)	Length
H43604	1/4	29/64	2750	11000	1	5	50', 500'
H43605	5/16	9/16	2500	10000	1-1/2	7	50', 500'
H43606	3/8	5/8	2250	9000	2	8	50', 250'
H43608	1/2	51/64	2000	8000	2-1/2	12	50', 250'
H43612	3/4	1-1/16	1250	5000	9-1/2	19	50'
H43616	1	1-3/8	1000	4000	12	25	50'

Fastenal Branch Personnel: Please Sold Request number of feet when ordering.

Part No.	Vendor No.	Hose I.D.	Price /Ft
400285-131280	H43604-50	1/4	\$2.90
400286-131280	H43604-500	*1/4	1.98
400287-131280	H43605-50	5/16	3.23
400288-131280	H43605-500	*5/16	2.67
400289-131280	H43606-50	3/8	2.65
400290-131280	H43606-250	*3/8	2.58
400291-131280	H43608-50	1/2	3.10
400292-131280	H43608-250	*1/2	2.98
400293-131280	H43612-50	*3/4	6.15
400294-131280	H43616-50	*1	10.03

H436 Twin Line Perforated Cover Hose SAE 100R7 - Multi-Tube

- **Typical Application:** In addition to its compatibility with most hydraulic fluids, the low effusion rate of this hose makes it ideally suited for carbon dioxide and nitrogen. Perforated cover permits breathing, eliminating condensation and blistering.
- **Inner Tube:** Nylon 11
- **Reinforcement:** 2 Fiber Braids
- **Braids Cover:** Polyurethane (Perforated)
- **Cover Color:** Black
- **Temperature Range:** -40°F to +200°F (-40°C to +93°C)
- **Hose Ends:** Coll-O-Crimp® E-Series; Field Attachable 436 N-Series



Specifications

Vendor No.	Hose I.D.	Hose O.D.	Work Pressure (PSI)	Min. Burst Pressure (PSI)	Min. Bend Radii	Wt/100 (ft)	Length
H43644	1/4, 1/4	29/64, 29/64	2,750	11,000	1	10	50', 250'
H43666	3/8, 3/8	5/8, 5/8	2,000	8,000	2	16	50', 250'
H43688	1/2, 1/2	51/64, 51/64	2,000	8,000	2-1/2	24	50', 250'

Fastenal Branch Personnel: Please Sold Request number of feet when ordering.

Part No.	Vendor No.	Hose I.D.	Price /Ft
400295-131280	H43644-50	1/4, 1/4	\$6.03
400309-131280	H43666-50	3/8, 3/8	6.65
400313-131280	H43688-50	1/2, 1/2	8.10

MEDIUM-HIGH PRESSURE HYDRAULIC HOSE

Medium-High Pressure Hydraulic Hose



Weatherhead

* ALL STARRED ITEMS ARE BULK QUANTITIES *

H104 Hydraulic Hose SAE 100R1 Type AT



- MSHA Accepted.
- **Typical Application:** Most commonly used for medium-pressure hydraulic lines. Especially popular for farm implement hydraulic lines.
- **Inner Tube:** Nitrile
- **Reinforcement:** 1 Steel Braid
- **Cover:** Neoprene
- **Temperature Range:** -40°F to +212°F (-40°C to +100°C)
- **Hose Ends:** Coll-O-Crimp® U-Series; Coll-O-Crimp® S-Series except -10 size; Field Attachable 104 N-Series, Z series (-4 to -10)

Specifications

Vendor No.	Hose I.D.	Hose O.D.	Work Pressure (PSI)	Min. Burst Pressure (PSI)	Min. Bend Radii	Wt/100 (ft)	Length
H10404	1/4	17/32	2750	11000	4	15	50', 250', 500'
H10406	3/8	23/32	2250	9000	5	23	50', 250', 500'
H10408	1/2	27/32	2000	8000	7	29	50', 250', 500'
H10410	5/8	31/32	1500	6000	8	35	50', 250'
H10412	3/4	1-1/8	1250	5000	9-1/2	41	50', 250'
H10416	1	1-7/16	1000	4000	12	55	50', 250'
H10420	1-1/4	1-3/4	625	2500	16-1/2	85	50', 100'

Fastenal Branch Personnel: Please Sold Request number of feet when ordering.

Part No.	Vendor No.	Hose I.D.	Price /Ft
400000-131280	H10404-50	1/4	\$2.28
400001-131280	H10404-250	1/4	2.28
400002-131280	H10404-500	*1/4	2.18
400003-131280	H10406-50	3/8	2.50
400004-131280	H10406-250	3/8	2.50
400005-131280	H10406-500	*3/8	2.43
400006-131280	H10408-50	1/2	2.85
400007-131280	H10408-250	1/2	2.85
400008-131280	H10408-500	*1/2	2.75
400009-131280	H10410-50	5/8	3.65
400010-131280	H10410-250	*5/8	3.63
400011-131280	H10412-50	3/4	4.60
400012-131280	H10412-250	*3/4	4.55
400013-131280	H10416-50	1	7.33
400014-131280	H10416-250	*1	7.22
400015-131280	H10420-50	1-1/4	12.34
0446962	H10420-100	*1-1/4	12.26

H169 Hydraulic Hose

- MSHA Accepted
- **Typical Application:** Medium pressure air, fuel, grease, oil, truck and power steering lines.
- **Inner Tube:** Nitrile
- **Reinforcement:** 1 Steel Braid
- **Cover:** Neoprene
- **Temperature Range:** -40°F to +212°F (-40°C to +100°C)
- **Hose Ends:** Coll-O-Crimp® 069 E-Series (except -32 size); Field Attachable 069 D-Series; 247 N-Series (except -20, -24 and -32 sizes)



Specifications

Vendor No.	Hose I.D.	Hose O.D.	Work Pressure (PSI)	Min. Burst Pressure (PSI)	Min. Bend Radii	Wt/100 (ft)	Length
H16905	1/4	37/64	3000	12000	3-3/8	20	50', 250'
H16906	5/16	43/64	2250	9000	4	23	50', 250'
H16908	13/32	49/64	2000	8000	4-5/8	27	50', 250'
H16910	1/2	59/64	1750	7000	5-1/2	36	50', 250'
H16912	5/8	1-5/64	1500	6000	6-1/2	44	50', 250'
H16916	7/8	1-15/64	800	3200	7-3/8	46	50', 250'
H16920	1-1/8	1-1/2	625	2500	9	51	50', 150'

Fastenal Branch Personnel: Please Sold Request number of feet when ordering.

Vendor Part No.	No.	Hose I.D.	Price /Ft.
400243-131280	H16905-50	1/4	\$5.34
400244-131280	H16905-250	*1/4	5.28
400245-131280	H16906-50	5/16	6.24
400246-131280	H16906-250	*5/16	6.15
400247-131280	H16908-50	13/32	5.23
400249-131280	H16910-50	1/2	7.38
400250-131280	H16910-250	*1/2	7.30
400251-131280	H16912-50	5/8	8.03
400252-131280	H16912-250	*5/8	7.93
400253-131280	H16916-50	*7/8	8.70
0446967	H16916-250	7/8	8.58
400254-131280	H16920-50	*1-1/8	10.78

Hydraulic Hose

MEDIUM - HIGH PRESSURE HYDRAULIC HOSE

Medium-High Pressure Hydraulic Hose Cont.

EATON | Weatherhead

Hydraulic Hose

H145 Hydraulic Hose

- SAE 100R17 Marine Application J1942/1 - Hydraulic only.
- MSHA Accepted
- **Typical Application:** Ideal for use in high-pressure lines on off-the-road construction equipment, farm equipment, and other high-pressure applications where a small bend radius is needed.
- **Inner Tube:** Nitrile
- **Reinforcement:** **4-6 Size:** 1 Steel Braid **8-16 Size:** 2 Steel Braids
- **Cover:** Neoprene
- **Temperature Range:** **4-8 Size:** -40°F to +250°F (-40°C to +121°C) **10-16 Size:** -40°F to +212°F (-40°C to +100°C)
- **Hose Ends:** Coll-O-Crimp® U-Series for 6-12 Sizes; Coll-O-Crimp® 430 U-Series for 16 Size; Coll-O-Crimp® S-Series (except -4 and -10), Z-Series.



Specifications

Vendor No.	Hose I.D.	Hose O.D.	Work Pressure (PSI)	Min. Burst Pressure (PSI)	Min. Bend Radii	Wt./100 (ft)	Length
H14504	1/4	15/32	3000	12000	2	13	50', 250', 500'
H14506	3/8	5/8	3000	12000	2-1/2	18	50', 250', 500'
H14508	1/2	13/16	3000	12000	3-1/2	36	50', 250', 500'
H14510	5/8	15/16	3000	12000	4	42	50', 250'
H14512	3/4	1-1/8	3000	12000	4-3/4	54	50', 250'
H14516	1	1-13/32	3000	12000	6	91	50', 250'

Fastenal Branch personnel: Please Sold Request number of feet when ordering.

Part No.	Vendor No.	Hose I.D.	Price /Ft
400324-131280	H14504-50	1/4	\$2.43
400325-131280	H14504-250	1/4	2.40
400326-131280	H14504-500	*1/4	2.28
400327-131280	H14506-50	3/8	2.48
400328-131280	H14506-250	3/8	2.45
400329-131280	H14506-500	*3/8	2.40
400330-131280	H14508-50	1/2	3.35
400331-131280	H14508-250	1/2	3.33
0446965	H14508-500	*1/2	3.98
400332-131280	H14510-50	5/8	5.93
400333-131280	H14510-250	*5/8	5.88
400334-131280	H14512-50	3/4	7.43
400335-131280	H14512-250	*3/4	7.38
400336-131280	H14516-50	1	10.60
400337-131280	H14516-250	*1	10.40

H114 Hydraulic Hose

- MSHA Accepted
- **Typical Application:** 3000 PSI continuous working pressure hose. Ideal for farm implement high-temperature hydraulic lines. Will work with synthetic or petroleum-based fluids.
- **Inner Tube:** Hytrel
- **Reinforcement:** 1 Steel Braid
- **Cover:** Neoprene
- **Temperature Range:** Air brake: -40°F to +250°F (-40°C to +121°C)
- **Hose Ends:** Coll-O-Crimp® U-Series; Coll-O-Crimp® S-Series



Specifications

Vendor No.	Hose I.D.	Hose O.D.	Work Pressure (PSI)	Min. Burst Pressure (PSI)	Min. Bend Radii	Wt./100 (ft)	Length
H11404	1/4	1/2	3000	12000	4	11	50', 250', 500'
H11406	3/8	41/64	3000	12000	5	18	50', 250', 500'
H11408	1/2	13/16	3000	12000	7	25	50', 250', 500'

Fastenal Branch Personnel: Please Sold Request number of feet when ordering.

Part No.	Vendor No.	Hose I.D.	Price /Ft
400315-131280	H11404-50	1/4	\$2.35
400317-131280	H11404-500	*1/4	2.33
400318-131280	H11406-50	3/8	2.70
400319-131280	H11406-250	3/8	2.58
400320-131280	H11406-500	*3/8	3.15
400321-131280	H11408-50	1/2	3.53
400323-131280	H11408-500	*1/2	4.08

H146 Hydraulic Hose

- **Typical Application:** 3000 PSI continuous working pressure hose. Ideal for Arctic cold weather hydraulic applications, as well as for farm implement high temperature hydraulic lines. Will work with synthetic or petroleum-based fluids.
- **Inner Tube:** Hytrel
- **Reinforcement:** 1 Steel Braid
- **Cover:** Abrasion Resistant Fiber Braid
- **Temperature Range:** -65°F to +250°F (-53°C to +121°C)
- **Hose Ends:** Coll-O-Crimp® U-Series



Specifications

Vendor No.	Hose I.D.	Hose O.D.	Work Pressure (PSI)	Min. Burst Pressure (PSI)	Min. Bend Radii	Wt./100 (ft)	Length
H14604	1/4	33/64	3000	12000	4	11	50', 250'
H14606	3/8	43/64	3000	12000	5	18	50', 250'
H14608	1/2	13/16	3000	12000	7	25	50', 250'

Fastenal Branch Personnel: Please Sold Request number of feet when ordering.

Part No.	Vendor No.	Hose I.D.	Price /Ft
400351-131280	H14604-250	*1/4	\$3.05
400352-131280	H14606-50	3/8	2.90
400353-131280	H14606-250	*3/8	2.83
400354-131280	H14608-50	1/2	4.83
400355-131280	H14608-250	*1/2	4.08

MEDIUM-HIGH & VERY HIGH PRESSURE HOSE

Medium-High Pressure Hydraulic Hose Cont.

EATON | Weatherhead

H545 Abrasion Resistant Constant Pressure Hydraulic Hose

- **Typical Application:** 3000 PSI constant working pressure hose with abrasion resistant hose. Ideal for logging, construction, mining and other off-highway applications.
- **Inner Tube:** Nitrile
- **Reinforcement:** 4-8 Size: 1 Steel Braid 8-16 Size: 2 Steel Braids
- **Cover:** Abrasion resistant (woven nylon)
- **Temperature Range:** -40°F to +250°F (-40°C to +121°C)
- **Hose Ends:** Caution Coll-O-Crimp® U-Series for 4-12 Sizes; Caution Coll-O-Crimp® 430 U-Series for 16 Size; Coll-O-Crimp® S-Series for 4, 6, 8, 12 Sizes.



Specifications

Vendor No.	Hose I.D.	Hose O.D.	Work Pressure (PSI)	Min. Burst Pressure (PSI)	Min. Bend Radii	Wt./100 (ft)	Length
H54504	1/4	17/32	3000	12000	2	14	50', 250', 500'
H54506	3/8	5/8	3000	12000	2-1/2	18	50', 250', 500'
H54508	1/2	13/16	3000	12000	3-1/2	32	50', 250', 500'
H54510	5/8	15/16	3000	12000	4	37	50', 250'
H54512	3/4	1-1/8	3000	12000	4-3/4	54	50', 250'
H54516	1	1-13/32	3000	12000	6	86	50', 250'

Fastenal Branch Personnel: Please Sold Request number of feet when ordering.

Part No.	Vendor No.	Hose I.D.	Price /ft
0400629	H54504-50	1/4	\$4.35
0400631	H54504-500	*1/4	4.08
0400632	H54506-50	3/8	3.83
0400633	H54506-250	3/8	3.70
0400634	H54506-500	*3/8	3.60
0400635	H54508-50	1/2	4.88
0400636	H54508-250	1/2	5.88
0400637	H54508-500	*1/2	5.63
0400638	H54510-50	5/8	7.80
0400639	H54510-250	*5/8	7.55
0400640	H54512-50	3/4	8.95
0400641	H54512-250	*3/4	8.68
0400642	H54516-50	1	13.93
0400643	H54516-250	*1	11.69

H190 High Pressure Hydraulic Hose SAE 100R1 Type AT, EN 853 Type 1SN

- MSHA Accepted/ISO 14364
- Typical Application: Transfer to hydraulic fluid, water and air
- Inner Tube: Nitrile
- Reinforcement: 1 Steel Braid
- Cover: Vinyl Nitrile
- Temp Range: Petroleum based Hydraulic Fluids. -40° to +212°F Water Based Hydraulic Fluids -40° to +158° Water +32°F to 158°F
- Hose Ends: WeatherGrip "Z" Series

Part No.	Vendor No.	Hose I.D.	Hose O.D.	Work Pressure (PSI)	Min. Burst Pressure (PSI)	Min. Bend Radii	Length	Price /ft
0400900	H19004	1/4	17/32	3,265	13,060	4	50'	\$2.56
0400901	H19004-250R	1/4	17/32	3,265	13,060	4	250'	2.43
0400903	H19006	3/8	11/16	2,610	10,440	5	150'	2.80
0400904	H19006-250R	3/8	11/16	2,610	10,440	5	250'	2.63
0400906	H19008	1/2	13/16	2,320	9,280	7	50'	3.23
0400907	H19008-250R	1/2	13/16	2,320	9,280	7	250'	3.06
0400909	H19010	5/8	15/16	1,885	7,540	8	50'	3.93
0400910	H19010-250R	5/8	15/16	1,885	7,540	8	250'	3.73
0400911	H19012	3/4	1-3/32	1,525	6,100	9-1/2	50'	5.20
0400912	H19012-250R	3/4	1-3/32	1,525	6,100	9-1/2	250'	4.93
0400913	H19016	1	1-13/32	1,275	5,100	12	50'	6.78
0400914	H19016-250R	1	1-13/32	1,275	5,100	12	250'	6.43

The : symbol after a price denotes that it is a Direct Ship Product (DSP) and shipping, availability & lead times may vary.

Very High Pressure Hydraulic Hose

EATON | Weatherhead

H350 Very High Pressure Hydraulic Hose

- **Typical Application:** Most commonly used for high pressure lines on off-the-road equipment, farm equipment and other high pressure applications. Will work with water/glycol, water and hydraulic fluids.
- **Inner Tube:** Nitrile
- **Reinforcement:** 6-12 Size: 2 Steel Braids 16 Size: 4 Spiral-Steel Braids
- **Cover:** Neoprene
- **Temperature Range:** 40°F to +212°F (-40°C to +100°C)
- **Note:** Size 16 is Made to Order
- **Hose Ends:** Coll-O-Crimp® U-Series for 6 & 8 Sizes; 430 U-Series for 12 & 16 Sizes



Specifications

Vendor No.	Hose I.D.	Hose O.D.	Work Pressure (PSI)	Min. Burst Pressure (PSI)	Min. Bend Radii	Wt./100 (ft)	Length
H35006	3/8	11/16	3500	14000	2-1/2	29	50', 250'
H35008	1/2	13/16	3500	14000	3-1/2	36	50', 250'
H35010	5/8	1	3500	14000	4	60	50', 250'
H35012	3/4	1-5/32	3500	14000	4-3/4	70	50', 250'
H35016	1	1-1/2	3500	14000	12	140	50', 150'

Fastenal Branch Personnel: Please Sold Request number of feet when ordering.

Part No.	Vendor No.	Hose I.D.	Price /ft
0401078	H35006-50	3/8	\$4.28
0401079	H35006-250	*3/8	3.88
0401080	H35008-50	1/2	6.03
0401081	H35008-250	*1/2	4.79
0401082	H35010-50	5/8	9.10
0401083	H35010-250	*5/8	8.13
0401084	H35012-50	3/4	12.33
0401085	H35012-250	*3/4	11.70
0401086	H35016-50	1	17.05
0447049	H35016-150	*1	19.78

H430 Very High Pressure Hydraulic Hose SAE 100R12

- Marine Application J1942/1 - Hydraulic only
- MSHA Accepted
- **Hose must be skived when using 430 'E' Series hose ends.**
- **Typical Application:** Used for very high-pressure hydraulic lines subjected to pressure surges and flexing. Typical applications include construction, mining, farming and high-performance industrial equipment.
- **Inner Tube:** Neoprene
- **Reinforcement:** 4 Spiral Steel Plies
- **Cover:** Hypalon
- **Cover Color:** Gray
- **Temperature Range:** -40°F to +250°F (-40°C to +121°C)
- **Hose Ends:** Coll-O-Crimp® 430 E-Series; Coll-O-Crimp® 430 U-Series "No Skive"



Specifications

Vendor No.	Hose I.D.	Hose O.D.	Work Pressure (PSI)	Min. Burst Pressure (PSI)	Min. Bend Radii	Wt./100 (ft)	Length
H43008	1/2	15/16	4000	16000	7	58	50'
H43012	3/4	1-7/32	4000	16000	9-1/2	87	50'
H43016	1	1-33/64	4000	16000	12	140	50'
H43020	1-1/4	1-7/8	3000	12000	16-1/2	184	50'
H43024	1-1/2	2-1/8	2500	10000	20	210	50'
H43032	2	2-21/32	2500	10000	25	281	50'

Fastenal Branch Personnel: Please Sold Request number of feet when ordering.

Part No.	Vendor No.	Hose I.D.	Price /ft
400376-131280	H43008-50	1/2	\$11.85
400377-131280	H43012-50	3/4	11.82
400378-131280	H43016-50	1	17.33
400379-131280	H43020-50	1-1/4	33.50
400380-131280	H43024-50	1-1/2	39.43
400381-131280	H43032-50	2	61.53

VERY HIGH PRESSURE HYDRAULIC HOSE

Very High Pressure Hydraulic Hose Cont.

EATON | Weatherhead

H470 Very High Pressure Hydraulic Hose SAE 100R13

- Marine Application J1942/1 - Hydraulic only; 12-20 Sizes only.
- MSHA Accepted
- **Typical Application:** Used for very high-pressure hydraulic lines subjected to pressure surges and flexing. Typical applications include construction, mining, farming and high-performance industrial equipment.
- **Inner Tube:** Neoprene
- **Reinforcement:** Multi-Spiral Steel (Sizes 8, 12, 16, 4 plies) (Sizes 20, 24, 32, 6 plies)
- **Cover:** Black Vinyl Nitrile
- **Cover Color:** Black
- **Temperature Range:** 8 Size: -40°F to +250°F (-40°C to +121°C) 12-32 Size: -40°F to +250°F (-40°C to +121°C)
- **Hose Ends:** Coll-O-Crimp® 470 E-Series; Coll-O-Crimp® 570 S-Series

8 Size does not meet SAE 100R13.



Specifications

Vendor No.	Hose I.D.	Hose O.D.	Work Pressure (PSI)	Min. Burst Pressure (PSI)	Min. Bend Radii	Wt./100 (ft)	Length
H47008*	1/2	31/32	5000	20000	7	65	50'
H47012	3/4	1-1/4	5000	20000	9-1/2	109	50'
H47016	1	1-17/32	5000	20000	12	142	50'
H47020	1-1/4	1-31/32	5000	20000	16-1/2	252	50'
H47024	1-1/2	2-1/4	5000	20000	20	325	50'
H47032	2	2-13/16	5000	20000	25	505	50'

Fastenal Branch Personnel: Please Sold Request number of feet when ordering.

Part No.	Vendor No.	Hose I.D.	Price /Ft
400382-131280	H47008	1/2	\$16.16
400383-131280	H47012	3/4	30.34
400384-131280	H47016	1	48.51
400385-131280	H47020	1-1/4	72.86
400386-131280	H47024	1-1/2	82.88
400387-131280	H47032	2	100.86

H245 High Pressure Hydraulic Hose Exceeds SAE 100R2 Type AT, Meets SAE 100R16

- Marine Application J1942/1 - Hydraulic Fluid - MSHA Accepted.
- **Typical Application:** Most commonly used for high-pressure lines on off-the-road construction equipment, farm equipment and other high-pressure applications. Will work with water/glycol, water, hydraulic fluids and diesel fuel.
- **Inner Tube:** Nitrile Blend
- **Reinforcement:** 2 Steel Braids
- **Cover:** Neoprene
- **Temperature Range:** -40°F to +212°F (-40°C to +100°C)
- **Hose Ends:** Coll-O-Crimp® U-Series; Coll-O-Crimp® S-Series (except -10 size); 430 U-Series for 12, 16, and 20 Sizes, Z-Series -4, -6, -8 and -10 only.



Specifications

Vendor No.	Hose I.D.	Hose O.D.	Work Pressure (PSI)	Min. Burst Pressure (PSI)	Min. Bend Radii	Wt./100 (ft)	Length
H24504	1/4	17/32	5000	20000	2	19	50', 250', 500'
H24506	3/8	11/16	4000	16000	2-1/2	29	50', 250', 500'
H24508	1/2	13/16	3500	14000	3-1/2	36	50', 250', 500'
H24510	5/8	15/16	2750	11000	4	42	50', 250'
H24512	3/4	1-3/32	2250	9000	4-3/4	54	50', 250'
H24516	1	1-13/32	2000	8000	6	81	50', 250'
H24520	1-1/4	1-25/32	1625	6500	8-1/4	114	50'

Fastenal Branch Personnel: Please Sold Request number of feet when ordering.

Part No.	Vendor No.	Hose I.D.	Price /Ft
400034-131280	H24504-50	1/4	\$3.31
400035-131280	H24504-250	1/4	3.24
400036-131280	H24504-500	*1/4	3.09
400037-131280	H24506-50	3/8	4.15
400038-131280	H24506-250	3/8	4.03
400039-131280	H24506-500	*3/8	3.60
400040-131280	H24508-50	1/2	4.28
400041-131280	H24508-250	1/2	4.19
0447000	H24508-500	*1/2	3.45
400042-131280	H24510-50	5/8	5.98
400043-131280	H24510-250	*5/8	4.79
400044-131280	H24512-50	3/4	6.43
400045-131280	H24512-250k	*3/4	6.35
400046-131280	H24516-50	1	8.46
400047-131280	H24516-250	*1	8.24
400048-131280	H24520-50	*1-1/4	26.61

VERY HIGH PRESSURE & MISCELLANEOUS HYDRAULIC HOSE

Very High Pressure Hydraulic Hose Cont.

EATON | Weatherhead

H425 High Pressure Hydraulic Hose SAE 100R2 Type AT

- MSHA Accepted.
- **Typical Application:** Most commonly used for high-pressure lines on off-the-road construction equipment, farm equipment and other high-pressure applications.
- **Inner Tube:** Nitrile (1/4" Neoprene)
- **Reinforcement:** 2 Steel Braids
- **Cover:** Neoprene
- **Temperature Range:** -40°F to +212°F (-40°C to +100°C)
- **Note:** 430U Series hose ends may be used on sizes 12-32 only
- **Hose Ends:** Coll-O-Crimp® U-Series except 24 and 32 Sizes; 430 U-Series; Coll-O-Crimp® S-Series for 4-20 Sizes; Field Attachable 425 N-Series; Coll-O-Crimp® 430 U-Series for 12-32 Sizes, Z-Series hose ends.



Specifications

Vendor No.	Hose I.D.	Hose O.D.	Work Pressure (PSI)	Min. Burst Pressure (PSI)	Min. Bend Radii	WT/100 (ft)	Length
H42504	1/4	19/32	5000	20000	4	28	50', 250', 500'
H42506	3/8	3/4	4000	16000	5	38	50', 250', 500'
H42508	1/2	7/8	3500	14000	7	45	50', 250', 500'
H42510	5/8	1	2750	11000	8	51	50', 250'
H42512	3/4	1-5/32	2250	9000	9-1/2	66	50', 250'
H42516	1	1-1/2	2000	8000	12	95	50', 250'
H42520	1-1/4	1-7/8	1625	6500	16-1/2	142	50', 150'
H42524	1-1/2	2-5/32	1250	5000	20	176	50', 100'
H42532	2	2-21/32	1125	4500	25	208	50'

Fastenal Branch Personnel: Please Sold Request number of feet when ordering.

Part No.	Vendor No.	Hose I.D.	Price /Ft
400016-131280	H42504-50	1/4	\$2.88
400017-131280	H42504-250	1/4	2.85
400018-131280	H42504-500	*1/4	2.75
400019-131280	H42506-50	3/8	3.33
400020-131280	H42506-250	3/8	3.33
400021-131280	H42506-500	*3/8	3.23
400022-131280	H42508-50	1/2	3.80
400023-131280	H42508-250	1/2	3.75
400024-131280	H42508-500	*1/2	2.84
400025-131280	H42510-50	5/8	4.68
400026-131280	H42510-250	*5/8	4.60
400027-131280	H42512-50	3/4	6.05
400028-131280	H42512-250	*3/4	6.03
400029-131280	H42516-50	1	7.93
400030-131280	H42516-250	*1	7.88
400031-131280	H42520-50	1-1/4	15.96
0447050	H42520-150	*1-1/4	19.19
400032-131280	H42524-50	1-1/2	24.65
0447051	H42524-100	*1-1/2	19.61
400033-131280	H42532-50	*2	28.66

Miscellaneous Hose

EATON | Weatherhead

ALL STARRED ITEMS ARE BULK QUANTITIES

H366 LP Hose UL File No. MH 6776. ULMH 10198.

- **Typical Application:** Most commonly used for medium-pressure LP gas service. UL listed for LP gas applications.
- **Inner Tube:** Nitrile
- **Reinforcement:** 1 Fiber Braid; 1 Stainless Steel Braid
- **Cover:** Fiber Braid
- **Temperature Range:** -40°F to +300°F (-40°C to +149°C)
- **Hose Ends:** Coll-O-Crimp® 069 E-Series; Field Attachable 069 D-Series; 247 N-Series



Specifications

Vendor No.	Hose I.D.	Hose O.D.	Work Pressure (PSI)	Min. Burst Pressure (PSI)	Min. Bend Radii	WT/100 (ft)	Length
H36606	5/16	43/64	350	1750	4	18	50'
H36608	13/32	49/64	350	1750	4-5/8	21	50'

Fastenal Branch Personnel: Please Sold Request number of feet when ordering.

Part No.	Vendor No.	Hose I.D.	Price /Ft
400131-131280	H36606-50	*5/16	\$6.48
400132-131280	H36608-50	*13/32	6.73

H243 TEFLON® Hose

- **Typical Application:** Hydraulic, air and stream lines. Particularly suited for air compressor discharge lines where vibration and high temperature are present.
- **Inner Tube:** Teflon
- **Reinforcement:** Single Stainless Steel Braid, 1" Size Double Stainless Steel Braid (Type 304)
- **Temperature Range:** -65°F to +450°F (-54°C to +232°C)
- **Note:** Not for use in applications requiring static dissipation.
- **Warning:** For Teflon hose application, E-Series fittings must be used with H243 .030" thin wall hose only.
- **Hose Ends:** Coll-O-Crimp® E-Series



For temperatures above 300°F (149°C) - Use burst pressure rating in parenthesis.

Specifications

Vendor No.	Hose I.D.	Hose O.D.	Work Pressure (PSI)	Min. Burst Pressure (PSI)	Min. Bend Radii	WT/100 (ft)	Length
H24303	3/16	5/16	3000	12000 (9600*)	2	6	50', 150'
H24304	1/4	23/64	3000	12000 (9600*)	3	8	50', 100'
H24305	5/16	27/64	2500	10000 (8000*)	4	10	50', 100'
H24306	3/8	1/2	2000	8000 (6000*)	5	12	50', 100'
H24308	1/2	41/64	1750	7000 (5500*)	6-1/2	15	50', 100'
H24312	3/4	57/64	1000	4000 (3500*)	9	22	50'
H24316	1	1-9/64	1000	4000 (3350*)	12	49	50'

Part No.	Vendor No.	Hose I.D.	Price /Ft.
0446998	H24303-50	3/16	\$4.88
400180-131280	H24304-50	1/4	6.25
400181-131280	H24304-100	1/4*	6.13
400182-131280	H24305-50	5/16	7.33
400184-131280	H24306-50	3/8	9.03
400185-131280	H24306-100	3/8*	8.88
400186-131280	H24308-50	1/2	11.98
400187-131280	H24308-100	1/2*	11.80
400188-131280	H24312-50	3/4*	16.80
400189-131280	H24316-50	1*	30.90

MISCELLANEOUS HOSE & HYDRAULIC HOSE ASSEMBLIES

Miscellaneous Hoses Cont.

FAT•N | Weatherhead

H345 Pressure Washer Hose

MSHA Accepted

• **Typical Application:** A pressure wash hose that is also ideal for use in high pressure lines on off-the-road construction equipment, farm equipment and other high pressure applications where a small bend radius is needed. Will work with water/glycol, water, hydraulic fluids and diesel fuel.

• **Inner Tube:** Nitrile

• **Reinforcement:** 1 Steel Braid

• **Cover:** Vinyl Nitrile

• **Cover Color:** Blue

• **Temperature Range: Pressure Washer Service:** Up to +200°F (+93°C) **Hydraulic Service:** Only -40°F to +250°F (-40°C)

• **Note:** 50' and 100' are continuous length.

• **Hose Ends:** Z series.



Specifications

Vendor No.	Hose I.D.	Hose O.D.	Work Pressure (PSI)	Min. Burst Pressure (PSI)	Min. Bend Radii	Wt./100 (ft)	Length
H34504	1/4	31/64	3000	12000	2	13	50', 100', 250', 500'
H34506	3/8	41/64	3000	12000	2-1/2	18	50', 100', 250', 500'
H34508	1/2	25/32	3000	12000	3-1/2	28	50', 100', 250', 500'

Fastenal Branch Personnel: Please Sold Request number of feet when ordering.

Part No.	Vendor No.	Hose I.D.	Price /Ft
400338-131280	H34504-50	1/4	\$2.43
400339-131280	H34504-100	1/4	2.28
400340-131280	H34504-250	1/4	2.33
400342-131280	H34506-50	3/8	2.58
400343-131280	H34506-100	3/8	2.40
400344-131280	H34506-250	3/8	2.28
400345-131280	H34506-500	*3/8	2.18
400346-131280	H34508-50	1/2	2.88
400347-131280	H34508-100	1/2	2.55



100R2-AT Hydraulic Hose Assemblies

All hoses meet or exceed SAE (Society of Automotive Engineers) J517 100R2AT specifications. Each assembly is blown out with air to remove potential debris from the assembly process. Smooth cover allows for easy cleaning and maintenance, making visual inspection easier for wear spots due to vibration or abrasion.

Tube: Black Oil-Resistant Synthetic Rubber

Reinforcement: Two High Tensile Steel Wire Braids

Cover: Black Oil & Ozone/Weather Resistant Synthetic Rubber

Temp Range: -40°F to +212°F

Fittings: Male NPT Connections (2-piece Factory Crimped)

Universal Hydraulic Hose is for use with petroleum based hydraulic fluid in the construction, industrial, and agricultural markets; on road paving equipment, concrete & asphalt machinery, graders, loaders, tractors, aerial platforms, mining, dock & rail yards, etc.



Part No.	Vendor No.	Length	Hose I.D.	Work Pressure (PSI)	Min. Burst Pressure (PSI)	Price /Each
0402498	98398162	36"	1/4	5000	20000	\$11.65
0402499	98398220	12"	3/8	4000	16000	9.57
0402500	98398226	24"	3/8	4000	16000	9.96
0402501	98398232	36"	3/8	4000	16000	11.85
0402502	98398238	48"	3/8	4000	16000	14.41
0402503	98398241	60"	3/8	4000	16000	16.95
0402504	98398244	72"	3/8	4000	16000	18.43
0402505	98398250	96"	3/8	4000	16000	22.68
0402506	98398256	120"	3/8	4000	16000	26.41
0402507	98398300	12"	1/2	3500	14000	9.91
0402508	98398306	24"	1/2	3500	14000	12.36
0402509	98398312	36"	1/2	3500	14000	14.63
0402510	98398318	48"	1/2	3500	14000	17.18
0402511	98398321	60"	1/2	3500	14000	19.41
0402512	98398324	72"	1/2	3500	14000	21.90
0402513	98398327	84"	1/2	3500	14000	24.96
0402514	98398330	96"	1/2	3500	14000	27.86
0402515	98398336	120"	1/2	3500	14000	33.44
0402516	98398339	132"	1/2	3500	14000	35.06
0402517	98398342	144"	1/2	3500	14000	36.69

CRIMP MACHINES, TOOLS AND ACCESSORIES

Crimp Machines, Tools and Accessories

FAT-N | Weatherhead

T-401 • Coll-O-Crimp® I

Freight May Apply
Part #449998-131280

The Coll-O-Crimp® I is the time-proven 'Mini-Factory' that you can easily set up in your own shop. Fast, easy, compact and various power sources available make this crimper versatile for even the smallest of workshops.

Capacity: 3/16" I.D. 1 fiber braid through 1 3/8" I.D. 1 wire I.D. 1 wire hose and 1-1/4" ID 2 wire hose

Mounting: FH-135X or C-40X Cabinet

Size: 16 1/4" high, 8" wide, 21 3/4" Deep

Weight: 113 lbs.

Capabilities: Can crimp up to 1-1/4" diameter and 2 wire braid hose.

Ordering Information: T-401 Coll-O-Crimp® Press with tooling includes one each of the following:

- T-400-1 Coil-O-Crimp® Press
- T-400-BB Switch
- T-400-2C U-Series Collet - 1/4"
- T-400-3C U-Series Collet - 3/8"
- T-400-4C U-Series Collet - 1/2"
- T-400-5C U-Series Collet - 3/4"
- T-400-6C U-Series Collet - 1"
- T-400-10 Spacer Ring - Black
- T-400-11 Spacer Ring - Silver
- T-400-62 Spacer Ring - Yellow
- 36" T-421U Pump to Press Hose Assembly
- T-400-M Instruction Kit
- T-400-8 Die Ring
- T-421U Electric Pump (220 Volt, 1-Phase)



*T-421U-110 optional 110v, 1 phase pump (available by special order only). Number for packages with optional 110v, 1 phase pump order.

Super I T-420-N

Freight May Apply
Part #0401101

The Coll-O-Crimp® Super I is a versatile machine ideal for your shop, factory, construction, and mine locations. Big capacity combined with lever-activated crimping gives you wide coverage and a quick and simple way to make factory-quality hose assemblies.

Capacity: 3/16" I.D. 1 fiber braid through 1 1/4" 6 spiral hose; for hoses other than 4 and 6 spiral, conversion tooling is required.

Mounting: Bench or C-40X cabinet.

Size: 22" high, 10" wide, 20 1/2" deep

Weight: 210 lbs.

Capabilities: Can crimp up to 1-1/4" diameter and 2 and 4 wire braid hose.

Ordering Information: T-420-N#Coll-O-Crimp® Super I Press with pump and tooling package includes one each of the following:

- T-420-1 Coil-O-Crimp® Super I Press
- T-420-25 Adapter Ring for T-400 Series Collets
- T-420-5CN 430 U-Series collet - 3/4"
- T-420-6CN 430 U-Series Collet - 1"
- T-400-10 Spacer Ring - Black
- T-400-62 Spacer Ring - Yellow
- T-400-2C U-Series Collet - 1/4"
- T-400-4C U-Series Collet - 1/2"
- T-400-6C U-Series Collet - 1"
- T-400-11 Spacer Ring - Silver
- T-400-3C U-Series Collet - 3/8"
- T-400-5C U-Series Collet - 3/4"
- T-410-4CN 430 U-Series Collet - 1/2"
- T-420-7CN 430 U-Series Collet
- T-420-4CN 430 U-Series Collet - 1/2"
- T-430-4CN 430 U-Series Collet - 1/2"
- T-421U Electric Pump (220 Volt, 1-Phase)



*T-421U-110 optional 110v, 1 phase pump (available by special order only). Number for packages with optional 110v, 1 phase pump order.

ET4000-006 • Coll-O-Crimp® II Plus

Freight May Apply
Part #0401103

The Coll-O-Crimp® II Plus is ideal for factory, high performance machine operations, construction and mine locations. This machine offers the capabilities of crimping all of the crimp style hose ends Weatherhead offers. With this coverage, this heavy-duty crimper can handle all of your crimping needs.

Capacity: 3/16" I.D. 1 fiber braid through 2" 6 spiral hose; for hoses other than 4 and 6 spiral, conversion tooling is required.

Mounting: Bench

Size: 29" high, 12" wide, 21" deep

Weight: 550 lbs.

Capabilities: Can crimp up to 2" 6-spiral hose.

Ordering Information: ET400-006 Coll-O-Crimp® II Plus Press with pump and tooling package includes one each of the following:

- ET4000-4 Press and Pump Package
- T-410-4CN 430 "U" N/S Collet - 1/2"
- T-410-5CN 430 "U" N/S Collet - 3/4"
- T-410-6CN 430 "U" N/S Collet - 1"
- T-410-7CN 430 "U" N/S Collet - 1-1/4"
- T-410-8N 430 "U" N/S Collet - 1-1/2"
- T-410-9N 430 "U" N/S Collet - 2"
- T-410-22 Hose Assembly
- T-441 Electric Pump (220 Volt, 2-Stage)

Note: These packages include tooling to crimp H430 U-Series hose.



WeatherGRIP Tooling

For use with new Weatherhead "Z series" WeatherGRIP fittings
ET1000TP-0001 Crimp Kit for use with ET1000 Crimpers and
WeatherGRIP "Z Series" Fittings

For Braided Hose Sizes -4 thru 20 one wire and two wire



Part No.		UOM	
0400915		/Ea	
Part # 0400915 includes:			
Collet		Spacer Ring	
Vendor Part No.	Fastenal Part No.	Vendor Part No.	Fastenal Part No.
ET400DC-M150S	0400960	ET1000SR-M100A	0400970
			PURPLE
ET400DC-M195S	0400961	T-400-62	449997-131280
			YELLOW
ET400DC-M230S	0400962	T-400-46R	0400971
			BLACK/TAN
T-420-86C	0400963	ET1000SR-M190D	0400972
			LT. GREEN
ET420DC-M380S	0400964	T-400-37	0447421
			GREEN
		T-400-10	0447385
			BLACK/TAN
		Pusher Extension	T-400-112
			0447397
			TAN
Vendor Part No.	Fastenal Part No.	ET420SR-M495A	0400974
			GRAY
ET-1000C-0012	N/A	ET420SR-M255A	0400975
			BLACK/SILVER
		T-420-29	0447511
			ORANGE
		T-420-82R	0400976
			BLACK/BLUE
		T-480-68	0447600
			BLUE

CRIMP MACHINES, TOOLS AND ACCESSORIES

Crimp Machines, Tools and Accessories Cont.

Crimping Machines



Weatherhead

ET400TP-0001 Crimp Kit for use with T-400 Crimpers and Weather Grip "Z Series" Fittings

For Braided Hose Sizes -4 thru 20 one wire and two wire



Part No.		UOM /Ea		
0400916		^		
Part # 0400916 includes:				
Collet		Spacer Ring		
Vendor Part No.	Fastenal Part No.	Vendor Part No.	Fastenal Part No.	Spacer Ring Color
ET400DC-M150S	0400960	ET1000SR-M100A	0400970	PURPLE
ET400DC-M195S	0400961	T-400-62	449997-131280	YELLOW
ET400DC-M230S	0400962	T-400-46R	0400971	BLACK/TAN
ET400DC-M245S	0400967	ET1000SR-M190D	0400972	LT. GREEN
ET400DC-M295S	0400968	T-400-37	0447421	GREEN
ET400DC-M375S	0400969	T-400-10	0447385	BLACK
		ET400SR-002	0400990	BLACK/GREEN
		T-400-48R	0400991	BLACK/ORANGE
		ET400SR-003	0400992	BLACK/PURPLE
		T-400-112	0447397	TAN

ET420TP-0001 Crimp Kit for use with T-420 Crimpers and Weather Grip "Z Series" Fittings

For Braided Hose Sizes -4 thru 16 one wire and -4 thru -20 two wire



Part No.		UOM /Ea		
0400917		^		
Part # 0400917 includes:				
Collet		Spacer Ring		
Vendor Part No.	Fastenal Part No.	Vendor Part No.	Fastenal Part No.	Spacer Ring Color
ET400DC-M150S	0400960	ET1000SR-M100A	0400970	PURPLE
ET400DC-M195S	0400961	T-400-62	449997-131280	YELLOW
ET400DC-M230S	0400962	T-400-46R	0400971	BLACK/TAN
T-420-86C	0400963	ET1000SR-M190D	0400972	LT. GREEN
ET400DC-M380S		T-400-37	0447421	GREEN
		T-400-10	0447385	BLACK/TAN
		T-400-112	0447397	TAN
		ET420SR-M495A	0400974	GRAY
		ET420SR-M295A		BLACK/SILVER
		T-420-29	0447511	ORANGE
		T-420-82R	0400976	BLACK/BLUE

ET440TP-0001 Crimp Kit for use with T-440 Crimpers and Weather Grip "Z Series" Fittings

For Braided Hose Sizes -4 thru -16 (no -10) one wire and two wire



Part No.		UOM /Ea		
0400918		^		
Part # 0400918 includes:				
Collet		Spacer Ring		
Vendor Part No.	Fastenal Part No.	Vendor Part No.	Fastenal Part No.	Spacer Ring Color
ET400DC-M150S	0400960	ET1000SR-M100A	0400970	PURPLE
ET400DC-M195S	0400961	T-410-41	449976-131280	YELLOW
ET400DC-M230S	0400962	T-400-46R	0400971	BLACK/TAN
T-440-86C	0400965	ET1000SR-M190D	0400972	LT. GREEN
ET400DC-M380S		T-400-37	0447421	GREEN
		T-400-10	0447385	BLACK
		T-400-112	0447397	TAN
		ET420SR-M495A	0400974	GRAY
		ET420SR-M295A		BLACK/SILVER
		T-420-29	0447511	ORANGE
		T-420-82R	0400976	BLACK/BLUE

ET460TP-0001 Crimp Kit for use with T-460 Crimpers and Weather Grip "Z Series" Fittings

For Braided Hose Sizes -4 thru -8 one wire



Part No.		UOM /Ea		
0400919		^		
Part # 0400919 includes:				
Collet		Spacer Ring		
Vendor Part No.	Fastenal Part No.	Vendor Part No.	Fastenal Part No.	Spacer Ring Color
ET400DC-M150S	0400960	ET1000SR-M100A	0400970	PURPLE
ET400DC-M195S	0400961	T-400-62	449997-131280	YELLOW
ET400DC-M230S	0400962	T-400-46R	0400971	BLACK/TAN
		ET1000SR-M190D	0400972	LT. GREEN
		T-400-37	0447421	GREEN
		T-400-10	0447385	BLACK
		T-400-112	0447397	TAN

CRIMP MACHINES, TOOLS AND ACCESS. & FILTRATION

Crimp Machines, Tools and Accessories Cont.



ET480TP-0001 Crimp Kit for T-480 Crimper and Weather Grip "Z Series" Fittings

For Braided Hose Sizes -4 thru -16 (not -10) for one wire and two wire



Part No.					UOM
Part No.					/Ea
0400920					^
Part # 0400920 includes:					
Collet		Spacer Ring			
Vendor Part No.	Fastenal Part No.	Vendor Part No.	Fastenal Part No.	Spacer Ring Color	
ET400DC-M150S	0400960	ET1000SR-M100A	0400970	PURPLE	
ET400DC-M195S	0400961	T-400-62	449997-131280	YELLOW	
ET400DC-M230S	0400962	T-400-46R	0400971	BLACK/TAN	
T-420-86C	0400963	ET1000SR-M190D	0400972	LT. GREEN	
ET420DC-M380S	0400964	T-400-37	0447421	GREEN	
		T-400-10	0447385	BLACK/TAN	
		T-400-112	0447397	TAN	
		ET420SR-M495A	0400974	GRAY	
		ET420SR-M255A	0400975	BLACK/SILVER	
		T-420-29	0447511	ORANGE	
		T-420-82R	0400976	BLACK/BLUE	

CRIMPER & ACCESSORIES PART NUMBERS

Part No.	Vendor No.	Includes	UOM
449999-131280	TA-1002	Identification Tool	^
449995-131280	T-138	Hand Tube Cutter	—
449996-131280	T-400-12	1-1/4" Collet	—
449997-131280	T-400-62	Yellow Spacer Ring	—
0442942	C-40X	Cabinet for T-420 and T-400	—
0442943	FH-135X	Cabinet for T-400	—

Filtration



BETAfit Elements

- Used for Hydraulic System Filter Replacements
- High Beta stability over element life
- High durability & consistent performance in systems with extreme fluid dynamics
- High dirt holding capacities
- Compatible with all major hydraulic fluids
- Material: Metal/Plastic/Glass

Part No.	Micron	Weight	Price /Ea	HYDAC Part No.	Parker Part No.	Pall Part No.
0423107	3	0.55	\$77.05	2060430	925798	HC9700FKP18H
0423108	5	0.55	77.05	2060431		HC9700FKN18H
0423109	10	0.85	71.30	2060432	925799	HC9700FKS18H
0423110	3	0.55	42.55	2060528	925778, 932668Q	HC9700FKP9H
0423111	5	0.55	42.55	2060529		HC9700FKN9H
0423112	10	0.5	39.10	2060530	925779, 932670Q, 925520	HC9700FDS9H
0423113	3	0.8	86.25	2060599	926697Q, 932653Q	HC9600FKP8H
0423114	6	0.8	86.25	2060600	926843Q, 932654Q	HC9600FKN8H
0423115	12	0.55	79.35	2060601	932340Q	HC9600FKS8H
0423116	25	0.55	79.35	2060602	930118Q, 930119Q	HC9600FKT8H
0423117	3	1.5	198.00	2060607	926698Q	HC9600FKP13H
0423118	6	1.5	138.00	2060608	926845Q	HC9600FKN13H
0423119	6	1.5	147.20	2060616	926890Q	HC9600FKN16H
0423120	12	1.5	135.70	2060617	926888Q	HC9600FKS16H
0423121	3	5	503.70	2060637		
0423122	6	5	503.70	2060638	927945, 932873Q	HC8300FKN39H
0423123	12	5.9	488.75	2060639	927946, 932874Q	HC8300FKS39H
0423124	3	1.5	156.40	2060767	F9810H00403H-TEST	HC9801FDP4H
0423125	3	3.5	230.00	2060789		
0423126	10	3.5	230.00	2060791	932676Q	
0423127	3	1.5	149.50	2060797	927723Q	HC9021FDP8H
0423128	10	1.5	149.50	2060799	927694	HC9021FKS8H
0423129	3	0.25	54.05	2060836	925602Q, 932616Q	HC9020FKP8H
0423130	12	0.25	49.45	2060838	925598, 925600Q, 932618Q	HC9020FKS8H
0423131	12	15	654.35	2060846	932874Q	HC8310FKS39H
0423132	3	2	112.70	2060860	927725Q	HC9021FDP4H
0423133	10	2	112.70	2060862	933577Q	HC9021FKS4H
0423134	3	2.5	212.75	2060933	HC9801FDP8	HC9801FDP8H
					HORZPAR-FITELEM	
0423135	3	1.5lbs	138.00	2065003		
0423136	5	1.5	138.00	2065004		HC9700FKN27H
0423137	10	1.5	132.25	2065005		

Hydraulic Filtration



Hydac Elements

- Used for Hydraulic System Filter Replacements
- High Beta stability over element life
- High durability & consistent performance in systems with extreme fluid dynamics
- High dirt holding capacities
- Compatible with all major hydraulic fluids



Part No.	HYDAC Vendor No.	Parker Vendor No.	Pall Vendor No.	Micron	Weight	Price /Ea
0423027	2055592	PR3309		10	1.39	\$127.65
0423028	2055595	PR3310		20	1.39	127.65
0423029	2055736	PR3172		3	1.39	120.75
0423030	2055737	PR3173		5	1.39	120.75
0423031	2055738	PR3174		10	1.39	115.00
0423032	2055739	PR3175		20	1.39	115.00
0423033	2055743			10	2.18	204.70
0423034	2055745	PR3201	HC2233FKP13H	3	2.71	239.20
0423035	2055746	PR3202		5	2.71	239.20
0423036	2055747	PR3203		10	2.71	217.35
0423037	2055748	PR3204		20	2.71	217.35
0423038	2055750	PR3114		3	0.6	74.75
0423039	2055751			5	0.6	74.75
0423040	2055752	PR3116		10	0.6	70.15
0423041	2055753	PR3117		20	0.6	70.15
0423042	2055754	PR3143		3	0.88	93.15
0423043	2055755	PR3144		5	0.88	93.15
0423044	2055756	PR3145		10	0.88	90.85
0423045	2055757	PR3146		20	0.88	194.35
0423046	2055760			10	1.63	110.40
0423047	2055761			20	1.63	110.40
0423048	2055898	PR3033		10	0.18	37.95
0423049	2055902	PR3056		3	0.24	55.20
0423050	2055903	PR3057		5	0.24	55.20
0423051	2055904	PR3058		10	0.24	52.90
0423052	2055905	PR3059		20	0.24	52.90
0423053	2055906	PR3085		3	0.4	60.95
0423054	2055907	PR3086		5	0.4	60.95
0423055	2055908	PR3087		10	0.4	57.50
0423056	2055909	PR3088		20	0.4	57.50
0423057	2055958	PR3064		3	0.51	79.35
0423058	2055959			5	0.51	79.35
0423059	2055960	PR3066		10	0.51	77.05
0423060	2055973	PR3093		3	0.82	102.35
0423061	2055974	PR3094		5	0.82	102.35
0423062	2055984	PR3122		3	0.99	144.90
0423063	2055985	PR3123		5	0.99	144.90
0423064	2055986	PR3124		10	0.99	136.85
0423065	2055988	PR3151		3	1.76	198.95
0423066	2055989	PR3152		5	1.76	198.95

Part No.	HYDAC Vendor No.	Parker Vendor No.	Pall Vendor No.	Micron	Weight	Price /Ea
0423067	2055990	PR3153		10	1.76	\$194.35
0423068	2056396			3	2.93	262.20
0423069	2056398			10	2.93	110.40
0423070	2056416	PR3209		3	4.74	496.80
0423071	2056417	PR3210		5	4.74	496.80
0423072	2056418	PR3211		10	4.74	472.65
0423073	2056437	PR3180		3	2.65	259.90
0423074	2056438	PR3181		5	2.65	259.90
0423075	2056439	PR3182		10	2.65	247.25
0423076	2056543	PR3034		20	0.29	37.95
0423077	2056688	PR3035		3	0.29	64.40
0423078	2056689	PR3036		5	0.29	64.40
0423079	2056690	PR3037		10	0.29	58.65
0423080	2055975	PR3095		10	0.82	58.65
0423081	2057041	934477		3	8.93	346.15
0423082	2059093	PR3241		10	0.24	49.45
0423083	2059096	PR3258		10	0.42	62.10
0423084	2059097	PR3259		20	0.42	62.10
0423085	2059099	PR3275		10	0.71	69.00
0423086	2059100	PR3276		20	0.71	69.00
0423087	2059102	PR3292		10	0.84	98.90
0423088	2059103	PR3293		20	0.84	98.90
0423089	2059105	PR3326		10	3.77	226.55
0423090	2059106	PR3327		20	3.77	226.55
0423091	2059108			10	7.61	328.90
0423092	2059110	934478		5	8.93	346.15
0423093	2059111	934236		10	8.93	322.00
0423094	2059112	934479		20	8.93	322.00
0423095	2060479	934570		3	14.33	691.15
0423096	2060480	934571		5	14.33	691.15
0423097	2060481	934234		10	14.33	639.40
0423098	2060482	934572		20	14.33	639.40
0423099	2060486			10	0.84	72.45
0423100	2060487			20	0.84	72.45
0423101	2060547			10	5.21	276.00
0423102	2065208	PR3224		10	0.15	37.95
0423103	2066202	934568		10	2.29	163.30
0423104	2066373	934569		20	2.29	163.30
0423105	2069160			10	0.53	42.55
0423106	2075371			5	0.53	74.75

U-Series Hose Ends



Typical Application: General purpose low, medium, and high pressure hydraulic.
Compatible Hose: H017, H039, H104, H105, H114, H115, H145*, H146, H245, H324, H350, H425, H545, H325
Pressure: Determined by maximum working pressure for hose size and hose end configuration, whichever is lesser.
Material: AISI/SAE 12L14 carbon steel
Plating: Zinc, yellow dichromate finish
Advantages: Wide selection of hose and end configurations, allowing a diverse number of applications. An ideal series to introduce hydraulics.
Assemble With: T-400-1, T-410-1, T-420-1, T-465-1, T-460, T-462, T-480, ET1000 and ET4000
Label Set: FS-1100
Note: H145 1" requires 430 U-Series.



BSPT Male Pipe Rigid

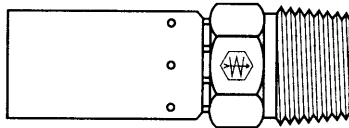

Hose x BSPT	Part No.	Vendor No.	Price /Each
1/4 x 1/4	410020-131280	04U-154	\$8.58
3/8 x 3/8	410021-131280	06U-156	15.74
1/2 x 1/2	410022-131280	08U-158	16.62
3/4 x 3/4	410023-131280	12U-162	24.48

BSPT = British Standard Pipe Tapered

Male Pipe Rigid

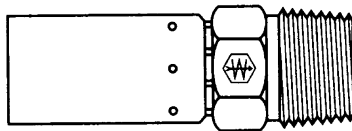

Hose x Pipe	Part No.	Vendor No.	Price /Each
1/4 x 1/8	410000-131280	04U-102	\$3.28
1/4 x 1/4	410001-131280	04U-104	4.13
1/4 x 3/8	410002-131280	04U-106	4.40
1/4 x 1/2	410003-131280	04U-108	5.93
3/8 x 1/4	410004-131280	06U-104	4.10
3/8 x 3/8	410005-131280	06U-106	4.65
3/8 x 1/2	410006-131280	06U-108	5.40
1/2 x 1/4	410007-131280	08U-104	11.61
1/2 x 3/8	410008-131280	08U-106	5.41
1/2 x 1/2	410009-131280	08U-108	5.43
1/2 x 3/4	410010-131280	08U-112	8.03
5/8 x 3/8	410011-131280	10U-106	13.38
5/8 x 1/2	410012-131280	10U-108	11.90
5/8 x 3/4	410013-131280	10U-112	10.71
3/4 x 1/2	410014-131280	12U-108	11.25
3/4 x 3/4	410015-131280	12U-112	10.23
3/4 x 1	410016-131280	12U-116	12.38
1 x 3/4	410017-131280	16U-112	12.80
1 x 1	410018-131280	16U-116	15.42
1-1/4 x 1-1/4	410019-131280	20U-120	32.13

Male DIN Universal Flareless Light

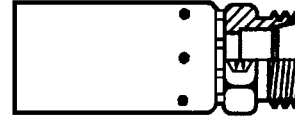

Hose x Tube	Part No.	Vendor No.	Price /Each
3/8 x 12 mm	0412746	06U-10A	\$35.08
1 x 28 mm	0412747	12U-22A	39.05

Male DIN 24° Seat Flareless Heavy

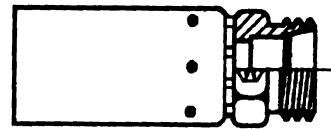

Hose x Tube	Part No.	Vendor No.	Price /Each
1/4 X 8 mm	0412736	04U-08F	\$37.05
1/2 x 10 mm	0412737	04U-10F	28.45
3/8 X 10 mm	0412738	06U-10F	28.18
3/8 X 12 mm	0412739	06U-12F	31.85
3/8 X 14 mm	0412740	06U-14F	33.13
1/2 X 16 mm	0412741	08U-16F	33.28
3/4 X 20 mm	0412743	12U-20F	51.13
3/4 X 25 mm	0412744	12U-25F	46.45

U-SERIES HOSE ENDS

U-Series Hose Ends Cont.

FASTENAL | Weatherhead

Hose Ends

BSPP 60° Cone Male Pipe Rigid

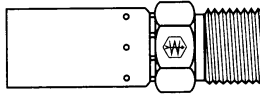

Hose x BSPP	Part No.	Vendor No.	Price /Each
1/4 x1/4	410025-131280	04U-P54	\$7.48
3/8 x3/8	410026-131280	06U-P56	12.60
3/8 x1/2	410027-131280	06U-P58	28.80
1/2 x3/8	410028-131280	08U-P56	29.03
1/2 x1/2	410029-131280	08U-P58	11.70
5/8 x5/8	410030-131280	10U-P60	40.02
3/4 x3/4	410031-131280	12U-P62	20.31
1 x 1	410032-131280	16U-P66	43.49

BSPP = British Standard Pipe Parallel

Male Pipe Swivel

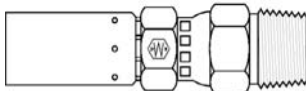

Hose x Pipe	Part No.	Vendor No.	Price /Each
1/4 x1/4	410039-131280	04U-J04	\$8.53
3/8 x1/4	410040-131280	06U-J04	9.03
3/8 x3/8	410041-131280	06U-J06	8.44
3/8 x1/2	410042-131280	06U-J08	9.33
1/2 x1/2	410043-131280	08U-J08	9.27
3/4 x3/4	410044-131280	12U-J12	14.05
1 x 1	410045-131280	16U-J16	26.38

Swivel for installation purposes only. Not for temperatures above 200° F.

FOR-SEAL® Male Rigid

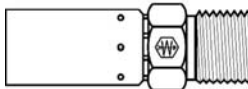

Hose x Tube	Part No.	Vendor No.	Price /Each
1/4 x1/4	410046-131280	04U-E64	\$7.57
3/8 x3/8	410047-131280	06U-E66	8.83
3/8 x1/2	0412748	06U-E68	29.13
1/2 x3/4	0412749	08U-E72	33.05
1/2 x1/2	410048-131280	08U-E68	9.98
5/8 x5/8	410049-131280	10U-E70	48.93
3/4 x3/4	410050-131280	12U-E72	46.31
3/4 x 1	410051-131280	12U-E76	70.50
1 x 1	410052-131280	16U-E76	47.56

Does not include O-ring.

SAE 37° (JIC) Male Rigid

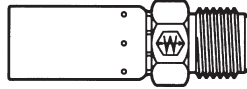

Hose x Tube	Part No.	Vendor No.	Price /Each
1/4 x1/4	410054-131280	04U-504	\$4.98
1/4 x5/16	410055-131280	04U-505	5.08
1/4 x3/8	410056-131280	04U-506	4.95
3/8 x3/8	410057-131280	06U-506	5.43
3/8 x1/2	410058-131280	06U-508	5.68
3/8 x5/8	410059-131280	06U-510	7.48
1/2 x1/2	410060-131280	08U-508	7.33
1/2 x5/8	410061-131280	08U-510	7.27
1/2 x3/4	410062-131280	08U-512	8.83
5/8 x1/2	410063-131280	10U-508	14.85
5/8 x5/8	410064-131280	10U-510	8.20
5/8 x3/4	410065-131280	10U-512	11.65
3/4 x5/8	410066-131280	12U-510	16.83
3/4 x3/4	410067-131280	12U-512	9.80
3/4 x7/8	410068-131280	12U-514	13.18
3/4 x 1	410069-131280	12U-516	13.85
1 x7/8	410070-131280	16U-514	37.43
1 x 1	410071-131280	16U-516	17.50
1 x 1-1/4	410072-131280	16U-520	44.00
1-1/4 x 1-1/4	410077-131280	20U-520	34.35

SAE 45° Flare Male Rigid

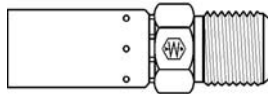

Hose x Tube	Part No.	Vendor No.	Price /Each
3/8 x3/8	410074-131280	06U-306	\$5.88
3/4 x3/4	410075-131280	12U-312	15.76

Inverted Male Swivel Straight

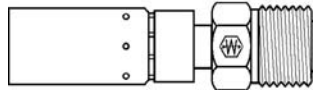

Hose x Tube	Part No.	Vendor No.	Price /Each
1/4 x3/16	410076-131280	04U-B03	\$7.68
1/4 x1/4	410073-131280	04U-B04	9.55
1/4 x5/16	410078-131280	04U-B05	10.05
3/8 x1/4	410079-131280	06U-B04	16.04
3/8 x5/16	410080-131280	06U-B05	9.88
3/8 x3/8	410081-131280	06U-B06	10.13
3/8 x7/16	410082-131280	06U-B07	9.48
1/2 x1/2	410083-131280	08U-B08	12.33
1/2 x5/8	410084-131280	08U-B10	14.05

Flareless Tube Rigid with Nut & Sleeve

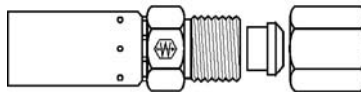

Hose x Tube	Part No.	Vendor No.	Price /Each
1/4 x1/4	410085-131280	04U-754	\$7.43
1/4 x5/16	410086-131280	04U-755	13.03
3/8 x1/4	410087-131280	06U-754	7.48
3/8 x5/16	410088-131280	06U-755	11.63
3/8 x3/8	410089-131280	06U-756	8.60
1/2 x1/2	410090-131280	08U-758	12.03
1/2 x5/8	410091-131280	08U-760	16.98
3/4 x3/4	410092-131280	12U-762	17.48
1 x 1	410093-131280	16U-766	25.75

Male Straight Thread O-Ring Rigid

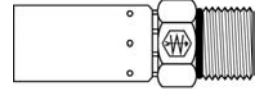

Hose x Tube	Part No.	Vendor No.	Price /Each
1/4 x1/4	410095-131280	04U-P04	\$6.80
1/4 x5/16	410096-131280	04U-P05	6.63
1/4 x3/8	410097-131280	04U-P06	6.73
3/8 x3/8	410098-131280	06U-P06	7.05
3/8 x1/2	410099-131280	06U-P08	6.30
3/8 x5/8	410100-131280	06U-P10	8.90
1/2 x1/2	410101-131280	08U-P08	6.20
1/2 x5/8	410102-131280	08U-P10	8.65
1/2 x3/4	410103-131280	08U-P12	11.33
5/8 x1/2	410104-131280	10U-P08	35.86
5/8 x5/8	410105-131280	10U-P10	12.03
5/8 x3/4	410106-131280	10U-P12	14.45
3/4 x5/8	410107-131280	12U-P10	16.73
3/4 x3/4	410108-131280	12U-P12	12.73
3/4 x 1	410109-131280	12U-P16	16.93
1 x 1	410110-131280	16U-P16	18.70
1-1/4 x 1-1/4	410111-131280	20U-P20	33.78

Male Straight Thread O-Ring Swivel

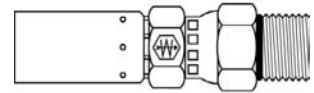

Hose x Tube	Part No.	Vendor No.	Price /Each
1/4 x1/4	0412854	06U-R04	\$16.76
3/8 x3/8	410113-131280	06U-R06	8.05
3/8 x1/2	410114-131280	06U-R08	8.90
1/2 x1/2	410115-131280	08U-R08	8.88
1/2 x5/8	410116-131280	08U-R10	9.08
1/2 x3/4	410117-131280	08U-R12	17.20
5/8 x1/2	410118-131280	10U-R08	53.00
3/4 x5/8	410120-131280	12U-R10	22.14

Swivel for installation purposes only.

Female Grease Tap

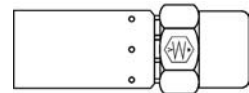

Hose	Part No.	Vendor No.	Price /Each
1/4	410121-131280	04U-C34	\$9.48
3/8	410122-131280	06U-C36	9.88

Female Pipe Rigid

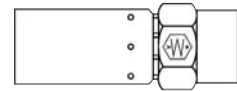

Hose x Pipe	Part No.	Vendor No.	Price /Each
1/4 x1/8	410123-131280	04U-202	\$5.33
1/4 x1/4	410124-131280	04U-204	6.98
3/8 x1/4	410125-131280	06U-204	6.90
3/8 x3/8	410126-131280	06U-206	6.55
1/2 x1/2	410127-131280	08U-208	7.43
3/4 x3/4	410128-131280	12U-212	11.25

U-Series Hose Ends Cont.



Female Pipe Swivel

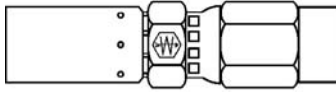

Hose x Pipe	Part No.	Vendor No.	Price /Each
1/4 x 1/4	410129-131280	04U-254	\$16.08
3/8 x 3/8	410130-131280	06U-256	17.07
1/2 x 1/2	410131-131280	08U-258	18.23
3/4 x 3/4	410132-131280	12U-262	28.83
1 x 1	0412750	16U-266	36.34

Female Straight Pipe Swivel NPSM

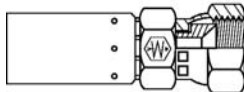

Hose x Pipe	Part No.	Vendor No.	Price /Each
1/4 x 1/4	410133-131280	04U-054	\$9.03
3/8 x 3/8	410134-131280	06U-056	9.70
1/2 x 1/2	410135-131280	08U-058	11.55
3/4 x 3/4	410136-131280	12U-062	19.35
1 x 1	410137-131280	16U-066	23.40
1-1/4 x 1-1/4	410138-131280	20U-070	46.08

Connects to male pipe with internal seat.

Female Swivel DIN Universal Seat Light

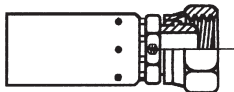

Hose x Tube	Part No.	Vendor No.	Price /Each
1/4 x 6 mm	410164-131280	04U-06C	\$11.78
1/4 x 8 mm	410165-131280	04U-08C	10.66
1/4 x 10 mm	410166-131280	04U-10C	9.58
3/8 x 10 mm	0412752	06U-10C	27.02
3/8 x 12 mm	410167-131280	06U-12C	9.48
1/2 x 15 mm	410168-131280	08U-15C	12.40
5/8 x 18 mm	410169-131280	10U-18C	19.53
3/4 x 22 mm	410170-131280	12U-22C	24.82
1 x 28 mm	410171-131280	16U-28C	43.33

Female Swivel DIN Universal Seat Heavy

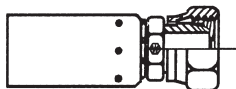

Hose x Tube	Part No.	Vendor No.	Price /Each
1/4 x 8 mm	410173-131280	04U-58C	\$11.25
1/4 x 10 mm	410174-131280	04U-60C	17.91
3/8 x 10 mm	0412853	06U-60C	23.38
3/8 x 12 mm	410175-131280	06U-62C	16.30
3/8 x 14 mm	410176-131280	06U-64C	20.58
1/2 x 16 mm	410177-131280	08U-66C	18.43
5/8 x 20 mm	410178-131280	10U-70C	42.95
3/4 x 25 mm	410179-131280	12U-75C	33.13
1 x 30 mm	410180-131280	16U-80C	59.53

*For use with H42520 only. Crimp on Super I, Coll-O-Crimp® II, or Coll-O-Crimp® II Plus. Includes O-ring.

Female Swivel 30° Flare Komatsu, Linkbelt, etc.

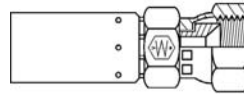

Hose	Part No.	Vendor No.	Price /Each
1/4	410181-131280	04U-14K	\$18.55
3/8	410182-131280	06U-18K	16.70
1/2	410183-131280	08U-22K	19.90
5/8	410184-131280	10U-24K	34.95
3/4	410185-131280	12U-30K	27.35
1	410186-131280	16U-33K	31.95

BSPF 60° Cone Female Pipe Swivel

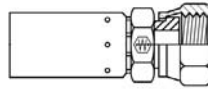

Hose x BSPF	Part No.	Vendor No.	Price /Each
1/4 x 1/4	410188-131280	04U-354	\$9.43
1/4 x 3/8	0412755	04U-356	16.77
3/8 x 3/8	410189-131280	06U-356	7.70
3/8 x 1/2	410190-131280	06U-358	10.84
1/2 x 1/2	410191-131280	08U-358	11.70
1/2 x 5/8	410192-131280	08U-360	13.63
5/8 x 5/8	410193-131280	10U-360	38.86
3/4 x 3/4	410194-131280	12U-362	16.43
1 x 1	410195-131280	16U-366	24.48

BSPF = British Standard Parallel Pipe

Female Swivel JIS 30° Flare

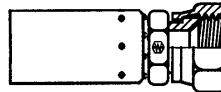

Hose x Tube	Part No.	Vendor No.	Price /Each
1/4 x 1/4	410197-131280	04U-04L	\$7.88
3/8 x 3/8	410198-131280	06U-06L	8.78
1/2 x 1/2	410199-131280	08U-08L	8.23
5/8 x 3/4	410200-131280	10U-12L	24.81
3/4 x 3/4	410201-131280	12U-12L	23.60
1 x 1	410202-131280	16U-16L	32.78

JIS = Japanese Industrial Standard

Female FOR-SEAL Swivel Straight

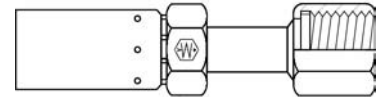

Hose x Tube	Part No.	Vendor No.	Price /Each
1/4 x 1/4	410203-131280	04U-S64	\$7.33
1/4 x 3/8	410204-131280	04U-S66	8.33
1/4 x 1/2	410205-131280	04U-S68	23.83
3/8 x 1/4	410206-131280	06U-S64	9.50
3/8 x 3/8	410207-131280	06U-S66	9.60
3/8 x 1/2	410208-131280	06U-S68	11.03
1/2 x 3/8	410209-131280	08U-S66	10.98
1/2 x 1/2	410210-131280	08U-S68	11.65
1/2 x 5/8	410211-131280	08U-S70	16.63
1/2 x 3/4	410212-131280	08U-S72	18.28
5/8 x 5/8	410213-131280	10U-S70	19.08
5/8 x 3/4	410214-131280	10U-S72	22.75
3/4 x 5/8	410215-131280	12U-S70	15.80
3/4 x 3/4	410216-131280	12U-S72	22.15
3/4 x 1	410217-131280	12U-S76	48.72
1 x 3/4	410218-131280	16U-S72	49.30
1 x 1	410219-131280	16U-S76	32.05
1 x 1-1/4	410220-131280	16U-S80	56.63
1-1/4 x 1-1/4	410221-131280	20U-S80	60.38

BSPF Flat Seat Female Swivel HIAB Cranes-Swedish

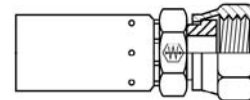

Hose x Connector	Part No.	Vendor No.	Price /Each
3/8 x 3/8	0412756	06U-06P	\$34.00
3/8 x 1/2	0412757	06U-08P	35.35
1/2 x 1/2	0412758	08U-08P	44.95
1/2 x 3/4	0412759	08U-12P	40.10

Banjo Ford Tractor

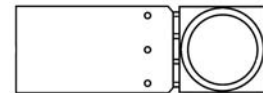

Hose	Part No.	Vendor No.	Price /Each
3/8	410223-131280	06U-L06	\$18.71

U-SERIES HOSE ENDS

U-Series Hose Ends Cont.



Hose Ends

Split Flange Straight Code 61

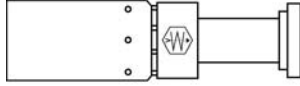

Hose x Flange	Part No.	Vendor No.	Price /Each
1/2 x 1/2	410230-131280	08U-G08	\$24.88
3/4 x 3/4	410231-131280	12U-G12	23.63
3/4 x 1	410232-131280	12U-G16	24.20
1 x 1	410233-131280	16U-G16	31.43
1-1/4 x 1-1/4	410235-131280	20U-G20	39.75

O-Ring not included.

Standpipe Straight Tube

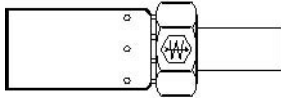

Hose x Tube	Part No.	Vendor No.	Price /Each
1/2 x 1/2	410240-131280	08U-T08	\$7.13
3/4 x 3/4	410242-131280	12U-T12	24.68

Metric Standpipe Straight Tube

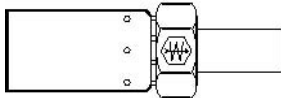

Hose x Tube	Part No.	Vendor No.	Price /Each
1/4 x 8 mm	410244-131280	04U-38T	\$22.80
1/4 x 10 mm	410245-131280	04U-40T	27.90
3/8 x 10 mm	410246-131280	06U-40T	24.00
3/8 x 12 mm	410247-131280	06U-42T	24.40
3/8 x 14 mm	410248-131280	06U-44T	30.19
1/2 x 15 mm	410249-131280	08U-45T	29.50
1/2 x 16 mm	410250-131280	08U-46T	23.45
3/4 x 22 mm	410262-131280	12U-52T	32.47
3/4 x 25 mm	410263-131280	12U-55T	42.18
1 x 28 mm	410264-131280	16U-58T	68.35

Inverted Male Swivel 45° Tube Elbow

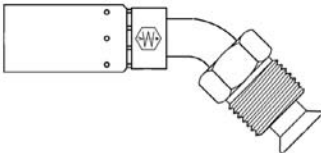

Hose x Tube	Part No.	Vendor No.	Price /Each
1/4 x 3/16	410267-131280	04U-B43	\$9.11
1/4 x 1/4	410268-131280	04U-B44	8.68
1/4 x 5/16	410269-131280	04U-B45	11.95
3/8 x 1/4	410270-131280	06U-B44	13.41
3/8 x 5/16	410271-131280	06U-B45	11.33
3/8 x 3/8	410272-131280	06U-B46	11.05
1/2 x 1/2	410274-131280	08U-B48	12.30

45° Hose End 7000 Ermeto® Series

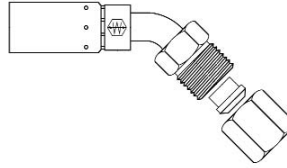

Hose x Tube	Part No.	Vendor No.	Price /Each
3/8 x 3/8	0412761	06U-956	\$18.24

SAE 37° (JIC) Female Swivel 45° Tube Elbow

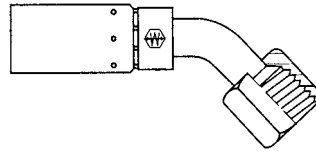

Hose x Tube	Part No.	Vendor No.	SAE OR JIC	Price /Each
1/4 x 1/4	410275-131280	04U-684	both	\$11.60
1/4 x 5/16	410276-131280	04U-685	both	12.13
3/8 x 1/4	410277-131280	06U-684	both	13.05
3/8 x 3/8	410278-131280	06U-486	SAE	11.75
3/8 x 3/8	410279-131280	06U-686	JIC	12.88
3/8 x 1/2	410280-131280	06U-688	both	13.78
1/2 x 1/2	410281-131280	08U-688	both	13.90
1/2 x 5/8	410282-131280	08U-690	both	19.18
5/8 x 3/4	410283-131280	10U-692	JIC	20.93
3/4 x 3/4	410284-131280	12U-692	JIC	27.20
3/4 x 1	0412765	12U-696	JIC	35.75
1 x 1	410285-131280	16U-696	JIC	47.85

Female Swivel DIN Universal Seat 45° Elbow (Light)

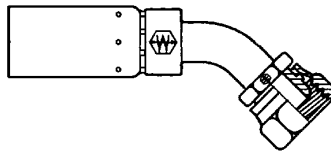

Hose x Tube	Part No.	Vendor No.	Price /Each
1/4 x 8 mm	410286-131280	04U-08D	\$20.67
3/8 x 10 mm	0412762	06U-10D	27.75
1/2 x 15 mm	410289-131280	08U-15D	23.48

BSPP 60° Cone Female Swivel 45° Elbow

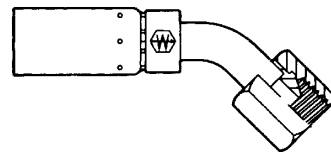

Hose x BSPP	Part No.	Vendor No.	Price /Each
1/4 x 1/4	410290-131280	04U-44P	\$19.15
3/8 x 3/8	410291-131280	06U-46P	15.05
1/2 x 1/2	410292-131280	08U-48P	27.75
1 x 1	410295-131280	16U-56P	63.73

*Part number will crimp in Coll-O-Crimp® T-410, T-420, T-440 and ET4000 presses only.
BSPP = British Standard Pipe Parallel

Female FOR-SEAL® Swivel 45° Tube Elbow

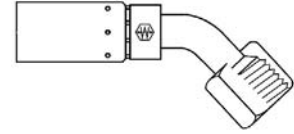

Hose x Tube	Part No.	Vendor No.	Price /Each
1/4 x 1/4	410297-131280	04U-L64	\$12.78
1/4 x 3/8	410298-131280	04U-L66	13.40
3/8 x 3/8	410299-131280	06U-L66	13.48
1/2 x 3/8	0412856	08U-L66	15.80
3/8 x 1/2	410300-131280	06U-L68	16.98
1/2 x 1/2	410301-131280	08U-L68	15.05
1/2 x 5/8	410302-131280	08U-L70	23.75
5/8 x 5/8	410303-131280	10U-L70	24.90
5/8 x 3/4	410304-131280	10U-L72	27.05
3/4 x 5/8	410305-131280	12U-L70	27.53
3/4 x 1	0412855	12U-L76	33.73
3/4 x 3/4	410306-131280	12U-L72	28.50
1 x 1	410308-131280	16U-L76	43.95
1-1/4 x 1-1/4	410309-131280	20U-L80	72.25

Split Flange 45° Tube Elbow Code 61

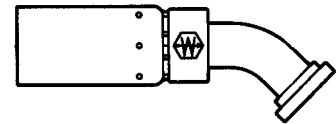

Hose x Flange	Part No.	Vendor No.	Price /Each
1/2 x 1/2	410311-131280	08U-G41	\$25.23
3/4 x 3/4	410312-131280	12U-G42	31.70
3/4 x 1	410313-131280	12U-G46	32.23
1 x 1	410314-131280	16U-G46	41.63
1 x 1-1/4	410315-131280	16U-G50	41.53

O-Ring not included.

Split Flange 45° Tube Elbow Komatsu, Linkbelt

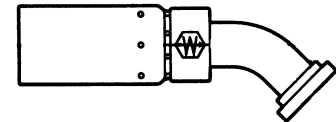

Hose x Flange	Part No.	Vendor No.	Price /Each
5/8 x 34 mm	410317-131280	10U-K69	\$29.73

O-Ring not included.

Male Pipe Swivel 90° Elbow

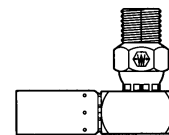

Hose x Pipe	Part No.	Vendor No.	Price /Each
1/4 x 1/4	410318-131280	04U-M04	\$22.55
3/8 x 1/4	410319-131280	06U-M04	18.05
3/8 x 3/8	410320-131280	06U-M06	15.75
1/2 x 1/2	410321-131280	08U-M08	11.05

Swivel for installation purposes only.

U-Series Hose Ends Cont.

FAT-N | Weatherhead

SAE 37° (JIC) Male Rigid 90° Elbow

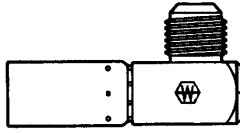

Hose x Tube	Part No.	Vendor No.	Price /Each
3/8 x5/8	410322-131280	06U-X60	\$18.17
1/2 x5/8	410323-131280	08U-X60	18.73

Inverted Male Swivel 90° Tube Elbow

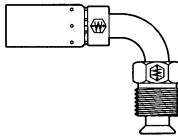

Hose x Tube	Part No.	Vendor No.	Price /Each
1/4 x3/16	410325-131280	04U-B63	\$8.01
1/4 x1/4	410326-131280	04U-B64	9.03
1/4 x5/16	410327-131280	04U-B65	11.88
3/8 x1/4	410328-131280	06U-B64	13.39
3/8 x5/16	410329-131280	06U-B65	11.10
3/8 x3/8	410330-131280	06U-B66	11.20
1/2 x1/2	410332-131280	08U-B68	12.73

90° Hose End 7000 Ermeto® Series

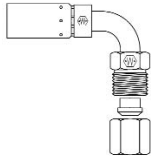

Hose x Tube	Part No.	Vendor No.	Price /Each
3/8 x3/8	0412767	06U-976	\$18.56

SAE 37° (JIC) Female Swivel 90° Tube Elbow

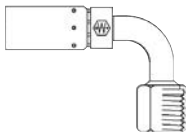

Hose x Tube	Part No.	Vendor No.	Price /Each
1/4 x1/4	410333-131280	04U-664	\$12.33
1/4 x5/16	410334-131280	04U-665	13.15
1/4 x3/8	410335-131280	04U-666	12.03
3/8 x1/4	410336-131280	06U-664	12.89
3/8 x3/8	410337-131280	06U-666	12.33
3/8 x1/2	410338-131280	06U-668	15.48
1/2 x1/2	410339-131280	08U-668	15.20
1/2 x5/8	410340-131280	08U-670	18.15
5/8 x5/8	410341-131280	10U-670	19.50
5/8 x3/4	410342-131280	10U-672	20.60
3/4 x5/8	410343-131280	12U-670	32.90
3/4 x3/4	410344-131280	12U-672	25.83
1 x 1	410345-131280	16U-676	41.83
1-1/4 x 1-1/4	410346-131280	20U-677	80.58

SAE 37° (JIC) Female Swivel Long Drop 90° Tube Elbow

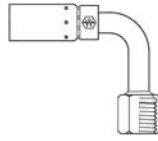

Hose x Tube	Part No.	Vendor No.	Price /Each
1/4 x1/4	0412768	04U-644	\$15.80
3/8 x1/4	410347-131280	06U-644	13.99
3/8 x3/8	410348-131280	06U-446	12.85
3/8 x3/8	410349-131280	06U-646	18.58
1/2 x1/2	410350-131280	08U-648	22.43
1/2 x5/8	410351-131280	08U-650	14.18
3/4 x3/4	410352-131280	12U-652	18.43
1 x 1	410353-131280	16U-656L33	30.70

Female Swivel DIN Universal Seat 90° Elbow Light

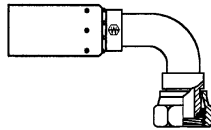

Hose x Tube	Part No.	Vendor No.	Price /Each
1/4 x 8 mm	410354-131280	04U-58D	\$18.70
1/4 x 10 mm	410355-131280	04U-60D	25.40
3/8 x 10 mm	0412769	06U-60D	38.38
3/8 x 12 mm	410356-131280	06U-62D	22.75
1/2 x 15 mm	410357-131280	08U-65D	28.28
5/8 x 18 mm	410358-131280	10U-68D	52.04
3/4 x 22 mm	410359-131280	12U-72D	46.38

Female 240° Swivel DIN 90° Elbow Heavy

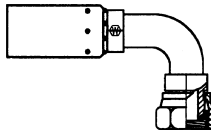

Hose x Tube	Part No.	Vendor No.	Price /Each
3/8 x 12 mm	410360-131280	06U-62E	\$40.28
3/8 x 14 mm	410361-131280	06U-64E	41.15
1/2 x 16 mm	410362-131280	08U-66E	34.18
5/8 x 20 mm	410363-131280	10U-70E	45.16
3/4 x 25 mm	410364-131280	*12U-75E	59.95
1 x 30 mm	410365-131280	*16U-80E	100.23

*Part number will crimp in Coll-O-Crimp® T-410, T-420, and T-440 presses only. Includes O-ring.

BSPP 60° Cone Female Pipe Swivel 90° Elbow

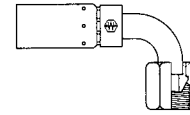

Hose x BSPP	Part No.	Vendor No.	Price /Each
1/4 x1/4	410366-131280	04U-74P	\$28.23
3/8 x3/8	410367-131280	06U-76P	25.98
1/2 x1/2	410368-131280	08U-78P	19.85
1/2 x5/8	410369-131280	08U-80P	36.30
3/4 x3/4	410371-131280	12U-82P	32.20
1 x 1	410372-131280	*16U-86P	55.42

*Will crimp in Coll-O-Crimp® T-410, T-440, and T-420 presses only.

BSPP = British Standard Pipe Parallel (BS2779)

Female FOR-SEAL® Swivel Short Drop 90° Tube Elbow

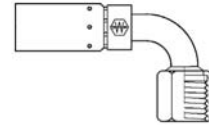

Hose x Tube	Part No.	Vendor No.	Price /Each
1/4 x1/4	410374-131280	04U-A24	\$12.58
1/4 x3/8	410375-131280	04U-A26	13.83
3/8 x1/4	410376-131280	06U-A24	14.53
3/8 x3/8	410378-131280	06U-A26	13.83
3/8 x1/2	410379-131280	06U-A28	16.03
1/2 x3/8	410380-131280	08U-A26	32.08
1/2 x1/2	410381-131280	08U-A28	16.10
1/2 x5/8	410382-131280	08U-A30	22.65
1/2 x3/4	410383-131280	08U-A32	41.15
5/8 x5/8	410384-131280	10U-A30	23.18
5/8 x3/4	410385-131280	10U-A32	25.48
3/4 x5/8	410386-131280	12U-A30	29.80
3/4 x3/4	410387-131280	12U-A32	28.08
3/4 x 1	410388-131280	12U-A36	60.18
1 x 1	410389-131280	16U-A36	40.08
1 x 1-1/4	410390-131280	16U-A40	79.20
1-1/4 x 1-1/4	410391-131280	20U-A40	74.60

Female FOR-SEAL® Swivel Medium Drop 90° Tube Elbow

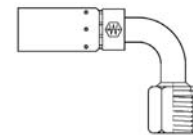

Hose x Tube	Part No.	Vendor No.	Price /Each
1/4 x1/4	410393-131280	04U-J34	\$13.70
1/4 x3/8	410394-131280	04U-J36	15.20
1/4 x1/2	410395-131280	04U-J38	30.83
3/8 x3/8	410396-131280	06U-J36	14.65
3/8 x1/2	410397-131280	06U-J38	17.23
1/2 x1/2	410399-131280	08U-J38	18.48
5/8 x5/8	0412773	10U-J40	21.13
3/4 x3/4	410402-131280	12U-J42	30.08
1 x 1	410403-131280	16U-J46	39.38

U-SERIES & WEATHERGRIP Z SERIES HOSE ENDS

U-Series Hose Ends Cont.

FAT-N | Weatherhead

Female FOR-SEAL® Swivel Long Drop 90° Tube Elbow

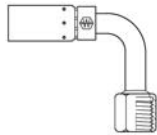

Hose x Tube	Part No.	Vendor No.	Price /Each
1/4 x 1/4	410405-131280	04U-A64	\$14.53
1/4 x 3/8	410406-131280	04U-A66	14.15
3/8 x 3/8	410407-131280	06U-A66	14.15
3/8 x 1/2	410408-131280	06U-A68	15.85
1/2 x 1/2	410409-131280	08U-A68	16.53
1/2 x 5/8	410410-131280	08U-A70	22.58
5/8 x 5/8	410411-131280	10U-A70	24.00
3/4 x 3/4	410412-131280	12U-A72	30.60
1 x 1	410413-131280	16U-A76	42.00

SAE 37° (JIC) Female Swivel 90° Elbow

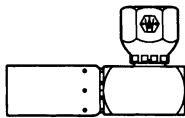

Hose x Tube	Part No.	Vendor No.	Price /Each
1/4 x 1/4	410416-131280	04U-554	\$24.53
3/8 x 3/8	410417-131280	06U-556	20.17
1/2 x 1/2	410418-131280	08U-558	20.30
1/2 x 5/8	410419-131280	08U-560	21.15
3/4 x 3/4	410421-131280	12U-562	47.55

Male Straight Thread O-Ring Swivel 90° Elbow

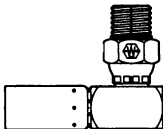

Hose x Tube	Part No.	Vendor No.	Price /Each
1/4 x 3/8	410423-131280	04U-R66	\$21.65
3/8 x 3/8	410424-131280	06U-R66	14.35
3/8 x 1/2	410425-131280	06U-R68	15.03
3/8 x 5/8	410426-131280	06U-R70	19.68
1/2 x 1/2	410427-131280	08U-R68	18.30
1/2 x 5/8	410428-131280	08U-R70	19.00
1/2 x 3/4	410429-131280	08U-R72	26.58
3/4 x 3/4	410430-131280	12U-R72	42.18

Swivel for installation purposes only.

Split Flange 90° Tube Elbow Code 61

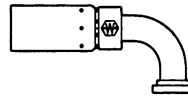

O-ring not included.

Hose x Flange	Part No.	Vendor No.	Price /Each
1/2 x 1/2	410431-131280	08U-G71	\$29.40
3/4 x 3/4	410432-131280	12U-G72	33.41
3/4 x 1	410433-131280	12U-G76	32.28
1 x 1	410434-131280	16U-G76	42.64
1 x 1-1/4	410435-131280	16U-G80	44.23
1-1/4 x 1-1/4	410436-131280	20U-G80	50.35
1-1/4 x 1-1/2	410437-131280	20U-G84	65.58

WeatherGRIP Z Series Hose Ends

FAT-N | Weatherhead

- Typical Application: General Purpose low, medium, and high pressure hydraulic
- Compatible Hose: H104, H145, H145R, H190, H190H, H245, H280, H290, H290H, H290L, H345, H350, H400, H425 AND H579
- Pressure: Determined by maximum working pressure for hose size and hose end configuration whichever is lesser.
- Material: Low Carbon Steel
- Plating: Zinc; yellow dichromate finish
- Advantages: Wide selection of hose and end configurations allowing a diverse number of applications
- Assemble with: T-400, T-410-1, T-420-1, T-440, T-460, T-462, T-465, T-480, ET1000 AND ET4000

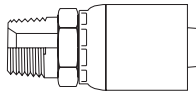

Male Pipe Rigid

Part No.	Vendor No.	Thread	Hose Size	Price
0413007	04Z-102	1/8"-27	1/4"	\$4.14
0405000	04Z-104	1/4"-18	1/4"	4.03
0413054	06Z-104	1/4"-18	3/8"	5.70
0413111	08Z-104	1/4"-18	1/2"	26.98
0413008	04Z-106	3/8"-18	1/4"	5.64
0405003	06Z-106	3/8"-18	3/8"	4.40
0413112	08Z-106	3/8"-18	1/2"	7.19
0413055	06Z-108	1/2"-14	3/8"	7.91
0405009	08Z-108	1/2"-14	1/2"	5.31
0405015	10Z-108	1/2"-14	5/8"	11.65
0413188	12Z-108	1/2"-14	3/4"	20.87
0413113	08Z-112	3/4"-14	1/2"	12.76
0405016	10Z-112	3/4"-14	5/8"	16.01
0413189	12Z-112	3/4"-14	3/4"	11.14
0413242	16Z-112	3/4"-14	1"	17.55
0413190	12Z-116	1"-11-1/2	3/4"	16.34
0413243	16Z-116	1"-11-1/2	1"	16.68

Female Pipe Swivel



Part No.	Vendor No.	Thread	Hose Size	Price
0413013	04Z-254	1/4"-18	1/4"	\$27.91
0413066	06Z-256	3/8"-18	3/8"	29.04
0413120	08Z-258	1/2"-14	1/2"	32.97
0413198	12Z-262	3/4"-14	3/4"	42.34

Male Pipe Swivel

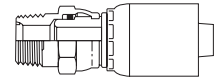

Part No.	Vendor No.	Thread	Hose Size	Price /Ea
0405002	04Z-J04	1/4"-18	1/4"	\$8.62
0405008	06Z-J06	3/8"-18	3/8"	9.20
0413155	08Z-J06	3/8"-18	1-1/8"	15.68
0413098	06Z-J08	1/2"-14	3/8"	22.96
0405014	08Z-J08	1/2"-14	1/2"	10.55
0413233	12Z-J12	3/4"-14	3/4"	22.14
0413278	16Z-J16	1"-11-1/2	1"	30.05

JIC/37° Female Swivel

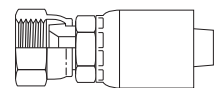

Part No.	Vendor No.	Thread	Hose Size	Price
0413021	04Z-603	3/8"-24	1/4"	\$34.89
0405001	04Z-604	7/16"-20	1/4"	4.77
0405004	06Z-604	7/16"-20	3/8"	5.89
0413022	04Z-605	1/2"-20	1/4"	5.93
0413075	06Z-605	1/2"-20	3/8"	26.16
0413023	04Z-606	9/16"-18	1/4"	5.68
0405005	06Z-606	9/16"-18	3/8"	5.54
0405006	06Z-608	3/4"-16	3/8"	5.89
0405010	08Z-608	3/4"-16	1/2"	7.05
0413176	10Z-608	3/4"-16	5/8"	19.98
0405011	08Z-610	7/8"-14	1/2"	7.15
0405018	10Z-610	7/8"-14	5/8"	12.53
0413207	12Z-610	7/8"-14	3/4"	14.15
0413128	08Z-612	1-1/16"-12	1/2"	13.75
0405019	10Z-612	1-1/16"-12	5/8"	12.55
0413208	12Z-612	1-1/16"-12	3/4"	13.20
0413256	16Z-612	1-1/16"-12	1"	23.41
0413209	12Z-614	1-3/8"-12	3/4"	23.15
0413129	08Z-616	1-5/16"-12	1/2"	30.57
0413210	12Z-616	1-5/16"-12	3/4"	18.51
0413257	16Z-616	1-5/16"-12	1"	22.06

JIC/37° Female Swivel 45° Elbow

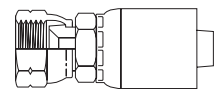

Part No.	Vendor No.	Thread	Hose Size	Price
0413030	04Z-684	7/16"-20	1/4"	\$13.09
0413031	04Z-685	1/2"-20	1/4"	15.88
0413032	04Z-686	9/16"-18	1/4"	14.63
0413082	06Z-686	9/16"-18	3/8"	14.18
0413083	06Z-688	3/4"-16	3/8"	13.63
0413136	08Z-688	3/4"-16	1/2"	15.23
0413137	08Z-690	7/8"-14	1/2"	22.62
0413178	10Z-690	7/8"-14	5/8"	20.83
0405022	10Z-692	1-1/16"-12	5/8"	26.10
0413214	12Z-692	1-1/16"-12	3/4"	29.68
0413261	16Z-696	1-5/16"-12	1"	44.36

WEATHERGRIP Z SERIES HOSE ENDS

WeatherGRIP Z Series Hose Ends Cont.



JIC/37° Female Swivel 90° Elbow

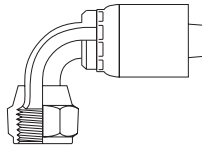

Part No.	Vendor No.	Thread	Hose Size	Price
0413027	04Z-664	7/16"-20	1/4"	\$12.79
0413028	04Z-665	1/2"-20	1/4"	16.15
0413029	04Z-666	9/16"-18	1/4"	13.70
0405007	06Z-666	9/16"-18	3/8"	12.69
0413132	08Z-666	9/16"-18	1/2"	22.25
0413081	06Z-668	3/4"-16	3/8"	15.93
0405013	08Z-668	3/4"-16	1/2"	14.89
0413135	08Z-670	7/8"-14	1/2"	19.42
0405020	10Z-670	7/8"-14	5/8"	21.86
0405021	10Z-672	1-1/16"-12	5/8"	23.07
0413212	12Z-672	1-1/16"-12	3/4"	28.39
0413213	12Z-676	1-5/16"-12	3/4"	49.42
0413260	16Z-676	1-5/16"-12	1"	41.67
0413299	20Z-677	1-5/8"-12	1-1/4"	76.97

JIC/37° Female Swivel 90° Long Drop Tube Elbow

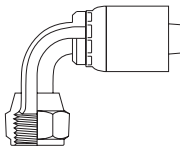

Part No.	Vendor No.	Thread	Hose Size	Price
0413025	04Z-644	7/16"-20	1/4"	\$22.44
0413026	04Z-645	1/2"-20	1/4"	27.25
0413078	06Z-646	8/16"-18	3/8"	18.48
0413079	06Z-648	3/4"-16	3/8"	26.95
0405012	08Z-648	3/4"-16	1/2"	23.42
0413131	08Z-650	7/8"-14	1/2"	32.05
0413177	10Z-650	7/8"-14	5/8"	23.24
0413211	12Z-652	1-1/16"-12	3/4"	36.69
0413259	16Z-656	1-5/16"-12	1"	54.87

JIC/37° Male Rigid

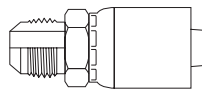

Part No.	Vendor No.	Thread	Hose Size	Price
0413017	04Z-504	7/16"-20	1/4"	\$8.69
0413018	04Z-505	1/2"-20	1/4"	6.45
0413019	04Z-506	9/16"-18	1/4"	7.30
0413073	06Z-506	9/16"-18	3/8"	6.08
0413074	06Z-508	3/4"-16	3/8"	6.86
0413125	08Z-508	3/4"-16	1/2"	7.52
0413126	08Z-510	7/8"-14	1/2"	8.64
0413174	10Z-510	7/8"-14	5/8"	12.58
0413202	12Z-510	7/8"-14	3/4"	22.12
0413127	08Z-512	1-1/16"-12	1/2"	18.66
0413175	10Z-512	1-1/16"-12	5/8"	12.44
0413203	12Z-512	1-1/16"-12	3/4"	10.56
0413204	12Z-514	1-3/16"-12	3/4"	28.81
0413205	12Z-516	1-5/16"-12	3/4"	15.31
0413254	16Z-516	1-5/16"-12	1"	19.13

Male Straight Thread O-Ring Rigid

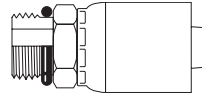

Part No.	Vendor No.	Thread	Hose Size	Price
0413045	04Z-P04	7/16"-20	1/4"	\$8.86
0413046	04Z-P05	1/2"-20	1/4"	13.90
0413047	04Z-P06	9/16"-18	1/4"	7.77
0413102	06Z-P06	9/16"-18	3/8"	7.46
0413103	06Z-P08	3/4"-16	3/8"	9.43
0413160	08Z-P08	3/4"-16	1/2"	8.34
0413161	08Z-P10	7/8"-14	1/2"	13.72
0413162	08Z-P12	1-1/16"-12	1/2"	33.94
0413186	10Z-P12	1-1/16"-12	5/8"	32.89
0413236	12Z-P12	1-1/16"-12	3/4"	17.85
0413237	12Z-P16	1-5/16"-12	3/4"	46.83
0413280	16Z-P16	1-5/16"-12	1"	27.11

Female FOR-SEAL Swivel

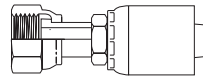

Part No.	Vendor No.	Thread	Hose Size	Price
0413049	04Z-S64	9/16"-18	1/4"	\$10.23
0413106	06Z-S64	9/16"-18	3/8"	22.15
0413050	04Z-S66	11/16"-16	1/4"	10.38
0413107	06Z-S66	11/16"-16	3/8"	11.17
0413164	08Z-S66	11/16"-16	1/2"	19.56
0413108	06Z-S68	13/16"-16	3/8"	11.53
0413165	08Z-S68	13/16"-16	1/2"	12.05
0413187	10Z-S68	13/16"-16	5/8"	13.25
0413166	08Z-S70	1"-14	1/2"	19.60
0405030	10Z-S70	1"-14	5/8"	16.47
0413239	12Z-S70	1"-14	3/4"	27.78
0413167	06Z-S72	1-3/16"-12	1/2"	23.87
0405031	10Z-S72	1-3/16"-12	5/8"	23.92
0413240	12Z-S72	1-3/16"-12	3/4"	23.41
0413282	16Z-S72	1-3/16"-12	1"	47.79
0413241	12Z-S76	1-7/16"-12	3/4"	29.21
0413283	16Z-S76	1-7/16"-12	1"	34.06

Female FOR-SEAL Swivel 45° Tube Elbow

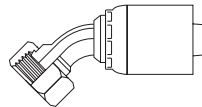

Part No.	Vendor No.	Thread	Hose Size	Price
0413043	04Z-L64	9/16"-18	1/4"	\$16.20
0413099	06Z-L64	9/16"-18	3/8"	21.98
0413044	04Z-L66	11/16"-16	1/4"	17.90
0413100	06Z-L66	11/16"-16	3/8"	15.59
0413156	08Z-L66	11/16"-16	1/2"	31.03
0413101	06Z-L68	13/16"-16	3/8"	22.48
0413157	08Z-L68	13/16"-16	1/2"	17.38
0413158	08Z-L70	1"-14	1/2"	29.68
0405028	10Z-L70	1"-14	5/8"	24.76
0413159	08Z-L72	1-3/16"-12	1/2"	31.31
0413234	12Z-L72	1-3/16"-12	3/4"	33.14
0413235	12Z-L76	1-7/16"-12	3/4"	84.68
0413279	16Z-L76	1-7/16"-12	1"	45.24

Female FOR-SEAL Swivel Short Drop 90° Tube Elbow

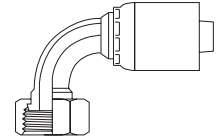

Part No.	Vendor No.	Thread	Hose Size	Price
0413034	04Z-A24	9/16"-18	1/4"	\$14.84
0413086	06Z-A24	9/16"-18	3/8"	41.78
0413035	04Z-A26	11/16"-16	1/4"	17.42
0413087	06Z-A26	11/16"-16	3/8"	16.15
0413138	08Z-A26	13/16"-16	1/2"	21.97
0413088	06Z-A28	13/16"-16	3/8"	18.07
0413139	08Z-A28	13/16"-16	1/2"	19.74
0413140	08Z-A30	1"-14	1/2"	24.71
0413218	12Z-A30	1"-14	3/4"	49.74
0413142	08Z-A32	1-3/16"-12	1/2"	56.73
0413219	12Z-A32	1-3/16"-12	3/4"	33.67
0413220	12Z-A36	1-7/16"-12	3/4"	50.65
0413265	16Z-A36	1-7/16"-12	1"	48.68

Female FOR-SEAL Swivel Long Drop 90° Tube Elbow

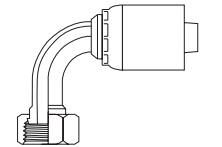

Part No.	Vendor No.	Thread	Hose Size	Price
0413036	04Z-A64	9/16"-18	1/4"	\$24.98
0413037	04Z-A66	11/16"-16	1/4"	53.44
0413089	06Z-A66	11/16"-16	3/8"	18.70
0413038	04Z-A68	13/16"-16	1/4"	47.52
0413090	06Z-A68	13/16"-16	3/8"	70.18
0413143	08Z-A68	13/16"-16	1/2"	20.74
0413144	08Z-A70	1"-14	1/2"	32.80
0413221	12Z-A72	1-3/16"-12	3/4"	37.52
0413222	12Z-A76	1-7/16"-12	3/4"	98.29
0413267	16Z-A76	1-7/16"-12	1"	50.55

FOR-SEAL Male Rigid

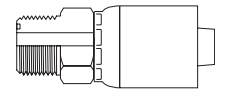

Part No.	Vendor No.	Thread	Hose Size	Price
0413042	04Z-E64	9/16"-18	1/4"	\$20.96
0413096	06Z-E66	11/16"-16	3/8"	13.66
0413097	06Z-E68	13/16"-16	3/8"	22.29
0413148	08Z-E68	13/16"-16	1/2"	24.71
0413223	12Z-E72	1-3/16"-12	3/4"	27.68
0413224	12Z-E76	1-7/16"-12	3/4"	29.03

Does not include O-Ring

Inverted Male Swivel Straight

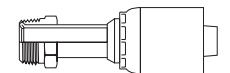

Part No.	Vendor No.	Thread	Hose Size	Price
0413039	04Z-B04	7/16"-24	1/4"	\$11.14
0413091	06Z-B05	1/2"-20	3/8"	62.76
0413092	06Z-B06	5/8"-18	3/8"	16.34
0413145	08Z-B08	3/4"-18	1/2"	44.19

Hose Ends

The : symbol after a price denotes that it is a Direct Ship Product (DSP) and shipping, availability & lead times may vary.

WEATHERGRIP Z SERIES HOSE ENDS

WeatherGRIP Z Series Hose Ends Cont.



Hose Ends

Inverted Male Swivel 45° Tube Elbow

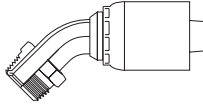

Part No.	Vendor No.	Thread	Hose Size	Price
0413040	04Z-B44	7/16"-24	1/4"	\$33.06
0413093	06Z-B46	5/8"-18	3/8"	28.55
0413146	08Z-B48	3/4"-18	1/2"	64.61

Inverted Male Swivel 90° Tube Elbow

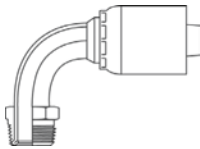

Part No.	Vendor No.	Thread	Hose Size	Price
0413041	04Z-B64	7/16"-24	1/4"	\$29.35
0413094	06Z-B65	1/2"-20	3/8"	80.12
0413095	06Z-B66	5/8"-18	3/8"	18.29
0413147	08Z-B68	3/4"-18	1/2"	65.05

Split Flange Straight (SAE Code 61)

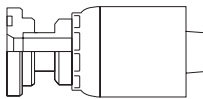

Part No.	Vendor No.	Flange Dia.	Hose Size	Price
0413149	08Z-G08	1.19"	1/2"	\$27.78
0413150	08Z-G12	1.5"	1/2"	37.03
0413181	10Z-G12	1.5"	5/8"	55.38
0413225	12Z-G12	1.5"	3/4"	26.67
0413226	12Z-G16	1.75"	3/4"	41.56
0413268	16Z-G16	1.75"	1"	34.46

Split Flange 45° Tube Elbow (SAE Code 61)

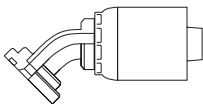

Part No.	Vendor No.	Flange Dia.	Hose Size	Price
0413151	08Z-G41	1.19"	1/2"	\$38.00
0413152	08Z-G42	1.5"	1/2"	77.38
0413182	10Z-G42	1.5"	5/8"	145.80
0413228	12Z-G42	1.5"	3/4"	34.68
0413229	12Z-G46	1.75"	3/4"	36.05
0413270	16Z-G46	1.75"	1"	44.45
0413271	16Z-G50	2"	1"	90.47

Split Flange 90° Tube Elbow (SAE Code 61)

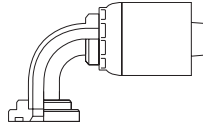

Part No.	Vendor No.	Flange Dia.	Hose Size	Price
0413153	08Z-G71	1.19"	1/2"	\$32.84
0413154	08Z-G72	1.5"	1/2"	37.52
0413230	12Z-G72	1.5"	3/4"	34.06
0413231	12Z-G76	1.5"	3/4"	36.19
0413272	16Z-G76	1.75"	1"	44.83
0413232	12Z-G80	2"	3/4"	174.89
0413273	16Z-G80	2"	1"	46.24
0413312	20Z-G80	2"	1-1/4"	50.78

British Standard (BSPP) 60° Cone Female Swivel Straight

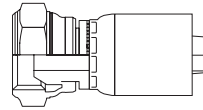

Part No.	Vendor No.	Thread	Hose Size	Price
0413014	04Z-354	G 1/4"-19	1/4"	\$9.27
0413067	06Z-356	G 3/8"-19	3/8"	9.35
0413068	06Z-358	G 1/2"-14	3/8"	9.52
0413121	08Z-358	G 1/2"-14	1/2"	9.56
0413200	12Z-362	G 3/4"-14	3/4"	20.96
0413253	16Z-366	G 1"-11	1"	36.38

British Standard 60° Cone Female 45° Tube Elbow

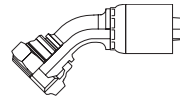

Part No.	Vendor No.	Thread	Hose Size	Price
0413016	04Z-44P	G1/4"-19	1/4"	\$22.66
0413072	06Z-46P	G3/8"-19	3/8"	25.67
0413124	08Z-48P	G1/2"-14	1/2"	33.40
0413206	12Z-52P	G3/4"-14	3/4"	62.79
0413255	16Z-56P	G1"-11	1"	97.01

British Standard 60° Cone Female 90° Tube Elbow

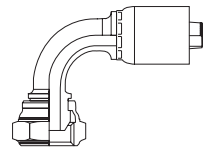

Part No.	Vendor No.	Thread	Hose Size	Price
0413033	04Z-74P	G1/4"-19	1/4"	\$12.35
0413084	06Z-76P	G3/8"-19	3/8"	13.83
0413085	06Z-78P	G1/2"-14	3/8"	28.24
0413217	12Z-82P	G3/4"-14	3/4"	38.91
0413264	16Z-86P	G1"-11	1"	74.35

BSPT Male Pipe Rigid

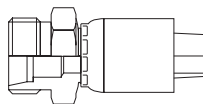

Part No.	Vendor No.	Thread	Hose Size	Price
0413012	04Z-154	R 1/4"-19	1/4"	\$15.17
0413064	06Z-156	R 3/8"-19	3/8"	13.29
0413114	08Z-158	R 1/2"-14	1/2"	19.41
0413193	12Z-162	R 3/4"-14	3/4"	25.91

British Standard 60° Cone Male Rigid

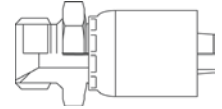

Part No.	Vendor No.	Thread	Hose Size	Price
0413048	04Z-P54	G1/14"-19	1/4"	\$17.50
0413104	06Z-P56	G3/8"-19	3/8"	18.21
0413105	06Z-P58	G1/2"-14	3/8"	13.20
0413163	08Z-P58	G1/2"-14	1/2"	22.17
0413238	12Z-P62	G3/4"-14	3/4"	30.05
0413281	16Z-P66	G1"-11	1"	56.41

Female Swivel DIN 24° Seat I.Rh DKO (Light)

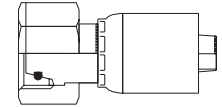

Part No.	Vendor No.	Thread	Hose Size	Price
0413003	04Z-06C	M12 X 1.5	1/4"	\$11.97
0413005	04Z-08C	M14 X 1.5	1/4"	10.95
0413057	06Z-10C	M16 X 1.5	3/8"	15.76
0413059	06Z-12C	M18 X 1.5	3/8"	13.58
0413116	08Z-15C	M22 X 1.5	1/2"	17.12
0413169	10Z-18C	M26 X 1.5	5/8"	25.14
0413195	12Z-22C	M30 X 2	3/4"	33.71
0413249	16Z-28C	M36 X 2	1"	44.60

Male DIN 24° Seat I.Rh (Light)

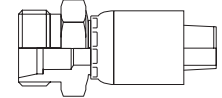

Part No.	Vendor No.	Thread	Hose Size	Price
0413002	04Z-06A	M12 X 1.5	1/4"	\$10.75
0413004	04Z-08A	M14 X 1.5	1/4"	10.43
0413056	06Z-10A	M16 X 1.5	3/8"	11.31
0413058	06Z-12A	M18 X 1.5	3/8"	10.48
0413168	10Z-18A	M26 X 1.5	5/8"	26.12
0413194	12Z-22A	M30 X 2	3/4"	34.89
0413248	16Z-28A	M36 X 2	1"	58.59

Female Swivel DIN 24° Seat s.Rh DKO (Heavy)

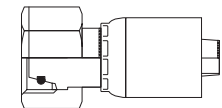

Part No.	Vendor No.	Thread	Hose Size	Price
0413020	04Z-58C	M16 X 1.5	1/4"	\$11.97
0413024	04Z-60C	M18 X 1.5	1/4"	14.72
0413076	06Z-62C	M20 X 1.5	3/8"	10.32
0413133	08Z-66C	M24 X 1.5	1/2"	20.36
0413179	10Z-70C	M30 X 2	5/8"	30.03
0413215	12Z-75C	M36 X 2	3/4"	40.46
0413262	16Z-80C	M42 X 2	1"	74.57

WEATHERGRIP Z SERIES & 430 U-SERIES HOSE ENDS

WeatherGRIP Z Series Hose Ends Cont.



Female Swivel DIN 24° Seat 90° Tube Elbow s.Rh DKO (Heavy)

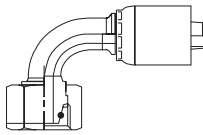

Part No.	Vendor No.	Thread	Hose Size	Price
0413077	06Z-62E	M20 X 1.5	3/8"	\$28.75
0413080	06Z-64E	M22 X 1.5	3/8"	57.68
0413134	08Z-66E	M24 X 1.5	1/2"	25.01
0413216	12Z-75E	M36 X 2	3/4"	63.18
0413263	16Z-80E	M42 X 2	1"	109.75

Male DIN 24° Seat s.Rh (Heavy)

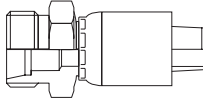

Part No.	Vendor No.	Thread	Hose Size	Price
0413006	04Z-08F	M16 X 1.5	1/4"	\$18.34
0413010	04Z-10F	M18 X 1.5	1/4"	26.22
0413061	06Z-12F	M20 X 1.5	3/8"	10.60
0413063	06Z-14F	M22 X 1.5	3/8"	40.27
0413118	08Z-16F	M24 X 1.5	1/2"	15.15
0413171	10Z-20F	M30 X 2	5/8"	28.99
0413197	12Z-25F	M36 X 2	3/4"	69.86
0413251	16Z-30F	M42 X 2	1"	73.04

Female JIS 30° Flare Swivel Straight

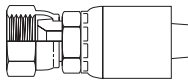

Part No.	Vendor No.	Thread	Hose Size	Price
0413000	04Z-04L	G1/4"-19	1/4"	\$29.94
0413051	06Z-06L	G3/8"-19	3/8"	14.40
0413109	08Z-08L	G1/2"-14	1/2"	18.00
0413191	12Z-12L	G3/4"-14	3/4"	49.94
0413246	16Z-16L	G1"-11	1"	80.69
0413288	20Z-20L	G1-1/4"-11	1-1/4"	95.70

Female Swivel 30° Flare (Komatsu, Linkbelt)

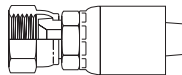

Part No.	Vendor No.	Thread	Hose Size	Price
0413011	04Z-14K	M14 X 1.5	1/4"	\$12.75
0413065	06Z-18K	M18 X 1.5	3/8"	18.92
0413119	08Z-22K	M22 X 1.5	1/2"	15.74
0413172	10Z-24K	M24 X 1.5	5/8"	31.39
0413199	12Z-30K	M30 X 1.5	3/4"	60.92
0413252	16Z-33K	M33 X 1.5	1"	89.99

430 U-Series No Skive Hose Ends



Typical Applications: Very high pressure hydraulic lines subjected to

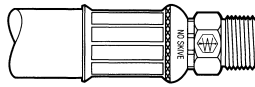

pressure surges and flexing. Some applications include mining, construction, farming and high performance industrial equipment.

Compatible Hose: H039, H115, H145, H245, H425, H350, H430 and H430R

Pressure: Determined by maximum working pressure for hose size.

Plating: Zinc, yellow dichromate finish

Advantages: Excellent selection of no-skive hose ends. Can be used with Caterpillar, John Deere, and many major manufacturers of heavy equipment.

Assemble with: T-410-1 Coll-O-Crimp® II and T-420-1 Coll-O-Crimp® Super I, T-440-1, ET4000

Also Available: Code 62

Male Pipe NPTF Rigid

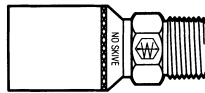

Hose x Pipe	Part No.	Vendor No.	Price /Each
1/2 x 1/2	0412893	43008U-108	\$12.45
1/2 x 3/4	0412894	43008U-112	20.90
3/4 x 3/4	410800-131280	43012U-112	15.85
3/4 x 1	410801-131280	43012U-116	32.46
1 x 1	410802-131280	43016U-116	23.85
1 x 1-1/4	410803-131280	43016U-120	35.73
1-1/4 x 1-1/4	410804-131280	43020U-120	37.65
1-1/2 x 1-1/2	0412895	43024U-124	55.78

British Standard 60° Cone (BSPP) Male Pipe Rigid

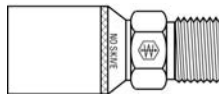

Hose x Tube	Part No.	Vendor No.	Price /Each
3/4 x 3/4	0412777	43012U-P62	\$43.58
1 x 1	0412778	43016U-P66	53.58

FOR-SEAL® Male Rigid

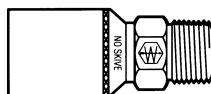

Hose x Tube	Part No.	Vendor No.	Price /Each
1/2 x 1/2	0412897	43008U-E68	\$18.84
3/4 x 3/4	410805-131280	43012U-E72	26.67
1 x 1	410806-131280	43016U-E76	45.28
1-1/4 x 1-1/4	410807-131280	43020U-E80	58.75

SAE 37° JIC Male Rigid

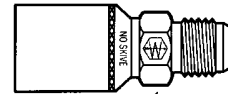

Hose x Tube	Part No.	Vendor No.	Price /Each
1/2 x 1/2	0412898	43008U-508	\$10.48
3/4 x 3/4	410808-131280	43012U-512	25.95
3/4 x 7/8	410809-131280	43012U-514	31.16
1 x 1	410810-131280	43016U-516	43.68
1-1/4 x 1-1/4	410811-131280	43020U-520	51.10
1 x 1-1/4	0412780	43016U-520	49.76
1-1/2 x 1-1/2	0412899	43024U-524	57.28

Male Straight Thread O-Ring Rigid

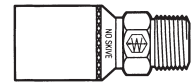

Hose x Tube	Part No.	Vendor No.	Price /Each
1 x 1	0412781	43016U-P16	\$43.75

SAE 37° JIC Female Swivel

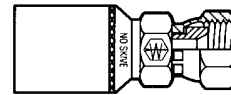

Hose x Tube	Part No.	Vendor No.	Price /Each
1/2 x 3/8	0412901	43008U-606	\$20.53
1/2 x 1/2	0412902	43008U-608	19.41
1/2 x 5/8	0412903	43008U-610	24.40
1/2 x 3/4	0412904	43008U-612	26.38
3/4 x 3/4	410812-131280	43012U-612	17.25
3/4 x 7/8	410813-131280	43012U-614	27.39
3/4 x 1	410814-131280	43012U-616	25.35
1 x 3/4	0412782	43016U-612	27.45
1 x 1	410815-131280	43016U-616	22.93
1 x 1-1/4	410816-131280	43016U-620	48.25
1-1/4 x 1-1/4	410817-131280	43020U-620	46.78
1-1/4 x 1-1/2	410818-131280	43020U-624	69.58

Female DIN Universal Seat Swivel (Light)

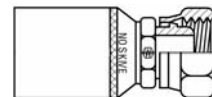

Hose x Tube (mm)	Part No.	Vendor No.	Price /Each
3/4 x 22 mm	0412783	43012U-22C	\$51.20

Female DIN 24° Seat Swivel (Heavy)

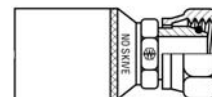

Hose x Tube (mm)	Part No.	Vendor No.	Price /Each
3/4 x 25 mm	0412784	43012U-75C	\$52.98
1-1/4 X 30 mm	0412786	43020U-80C	77.53

Hose Ends

430 U-SERIES No SKIVE HOSE ENDS

430 U-Series No Skive Hose Ends Cont.

FAT-N | **Weatherhead**

Female FOR-SEAL® Swivel Straight

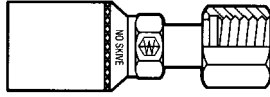

Hose x Tube	Part No.	Vendor No.	Price /Each
1/2 x 1/2	0412917	43008U-S68	\$21.40
1/2 x 5/8	0412918	43008U-S70	29.13
3/4 x 5/8	0412787	43012U-S70	38.15
3/4 x 3/4	410825-131280	43012U-S72	31.68
3/4 x 1	410826-131280	43012U-S76	42.00
1 x 1	410827-131280	43016U-S76	45.60
1 x 1-1/4	0412788	43016U-S80	84.38
1-1/4 x 1-1/4	410828-131280	43020U-S80	74.83
1-1/2 x 1-1/2	0412919	43024U-S84	103.78

Split Flange Straight Code 61

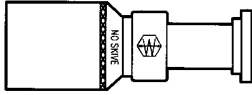

Hose x Flange	Part No.	Vendor No.	Price /Each
1/2 x 1/2	0412920	43008U-G08	\$23.93
1/2 x 3/4	0412921	43008U-G12	22.98
3/4 x 3/4	410832-131280	43012U-G12	26.48
3/4 x 1	410833-131280	43012U-G16	26.68
1 x 1	410835-131280	43016U-G16	35.13
1 x 1-1/4	410836-131280	43016U-G20	38.73
1 x 1-1/2	410837-131280	43016U-G24	49.15
1-1/4 x 1-1/4	410838-131280	43020U-G20	47.25
1-1/4 x 1-1/2	410839-131280	43020U-G24	50.88
1-1/4 x 1-1/2	410840-131280	43020U-G24L64	82.28
1-1/2 x 1-1/2	0412922	43024U-G24	76.43
1-1/2 x 2	0412923	43024U-G32	75.27

Split Flange Straight Code 62

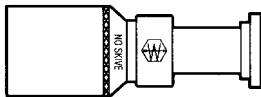

Hose x Flange	Part No.	Vendor No.	Price /Each
1/2 x 1/2	0412926	43008U-D08	\$31.25
1/2 x 3/4	0412927	43008U-D12	41.45
3/4 x 3/4	410842-131280	43012U-D12	32.75
3/4 x 1	410843-131280	43012U-D16	43.25
1 x 1	410844-131280	43016U-D16	56.75
1 x 1-1/4	410845-131280	43016U-D20	61.48
1-1/4 x 1-1/4	410846-131280	43020U-D20	56.53
1-1/4 x 1-1/2	410847-131280	43020U-D24	61.35

Split Flange 22-1/2° Tube Elbow Code 61

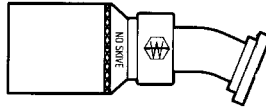

Hose x Flange	Part No.	Vendor No.	Price /Each
1/2 x 1/2	0412930	43008U-H01	\$20.42
3/4 x 3/4	410848-131280	43012U-H02	31.03
1 x 1	410850-131280	43016U-H03	44.23
1-1/4 x 1-1/4	410852-131280	43020U-H04	65.13
1-1/4 x 1-1/2	410853-131280	43020U-H05	65.23
1-1/2 x 1-1/2	0412932	43024U-H05	125.30

Split Flange 30° Tube Elbow Code 61

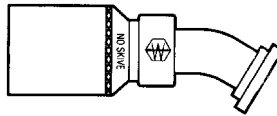

Hose x Flange	Part No.	Vendor No.	Price /Each
3/4 x 1	410855-131280	43012U-H23	\$33.48
1 x 1	410856-131280	43016U-H23	41.80
1-1/4 x 1-1/2	410859-131280	43020U-H25	76.08
1-1/2 x 1-1/2	0412937	43024U-H25	99.72

SAE 37° JIC Female Swivel 45° Tube Elbow

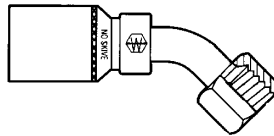

Hose x Tube	Part No.	Vendor No.	Price /Each
1/2 x 1/2	0412906	43008U-688	\$34.58
1/2 x 5/8	0412907	43008U-690	32.25
3/4 x 3/4	410860-131280	43012U-692	37.33
1 x 1	410861-131280	43016U-696	64.55

Female FOR-SEAL® Swivel 45° Tube Elbow

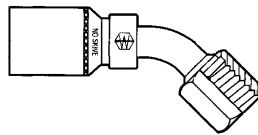

Hose x Tube	Part No.	Vendor No.	Price /Each
1/2	0412940	43008U-L68	\$41.20
1/2 x 5/8	0412941	43008U-L70	43.35
3/4 x 3/4	410862-131280	43012U-L72	46.93
1 x 1	410863-131280	43016U-L76	63.55

Split Flange 45° Tube Elbow Code 61

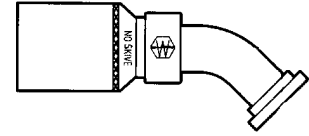

Hose x Flange	Part No.	Vendor No.	Price /Each
1/2	0412943	43008U-G41	\$26.33
1/2 x 3/4	0412944	43008U-G42	29.19
3/4 x 3/4	410864-131280	43012U-G42	29.73
3/4 x 1	410865-131280	43012U-G46	32.60
1 x 1	410866-131280	43016U-G46	49.20
1 x 1-1/4	410867-131280	43016U-G50	43.73
1-1/4 x 1-1/4	410868-131280	43020U-G50	132.07
1-1/4 x 1-1/2	410869-131280	43020U-G54	68.83
1-1/2 x 1-1/2	0412946	43024U-G54	78.98

Split Flange 45° Tube Elbow Code 62

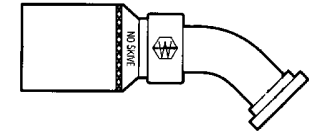

Hose x Flange	Part No.	Vendor No.	Price /Each
1/2	0412949	43008U-D41	\$33.33
3/4 x 3/4	410870-131280	43012U-D42	37.53
3/4 x 1	410871-131280	43012U-D46	41.68
1 x 1	410872-131280	43016U-D46	59.27
1 x 1-1/4	410873-131280	43016U-D50	74.53
1-1/4 x 1-1/4	410874-131280	43020U-D50	71.50

Split Flange 60° Tube Elbow

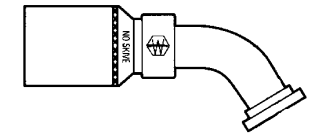

Hose x Flange	Part No.	Vendor No.	Price /Each
1/2 x 1/2	0412953	43008U-H51	\$27.73
1/2 x 3/4	0412954	43008U-H52	30.80
3/4 x 3/4	410878-131280	43012U-H52	32.60
3/4 x 1	410879-131280	43012U-H53	40.63
1 x 1	410880-131280	43016U-H53	52.33
1-1/4 x 1-1/4	410882-131280	43020U-H54	79.73
1-1/4 x 1-1/2	410883-131280	43020U-H55	82.88
1-1/2 x 1-1/2	0412955	43024U-H55	109.65
1-1/2 x 2	0412956	43024U-H56	129.83

Split Flange 67-1/2° Tube Elbow Code 61

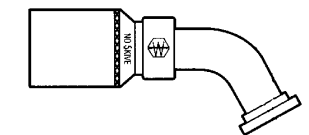

Hose x Flange	Part No.	Vendor No.	Price /Each
1/2 x 1/2	0412958	43008U-H61	\$22.28
3/4 x 3/4	410884-131280	43012U-H62	34.88
1 x 1	410887-131280	43016U-H63	42.03
1 x 1-1/4	410888-131280	43016U-H64	55.33
1-1/4 x 1-1/2	410890-131280	43020U-H65	84.73
1-1/2 x 1-1/2	0412961	43024U-H65	99.77

430 U-SERIES, S-SERIES & N-SERIES HOSE ENDS

430 U-Series No Skive Hose Ends Cont.



SAE 37° JIC Female Swivel 90° Tube Elbow

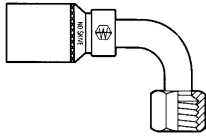

Hose x Tube	Part No.	Vendor No.	Price /Each
1/2 x 1/2	0412911	43008U-668	\$36.83
1/2 x 1/2	0412908	43008U-648L36	28.80
1/2 x 1/2	0412909	43008U-648L45	32.85
1/2 x 5/8	0412912	43008U-670	38.28
1/2 x 5/8	0412910	43008U-650	39.55
3/4 x 3/4	410891-131280	43012U-652	43.25
3/4 x 3/4	410892-131280	43012U-672	38.03
1 x 1	410893-131280	43016U-656L33	61.88
1 x 1	410894-131280	43016U-656L56	64.43
1 x 1	410895-131280	43016U-676	64.43
1-1/4 x 1-1/4	0412993	43020U-677	82.73

Female FOR-SEAL® Swivel 90° Short Drop Tube Elbow

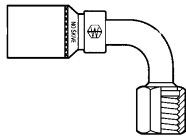

Hose x Tube	Part No.	Vendor No.	Price /Each
1/2 x 1/2	0412964	43008U-A28	\$41.20
1/2 x 5/8	0412965	43008U-A30	39.45
3/4 x 5/8	0412789	43012U-A30	33.30
3/4 x 3/4	410896-131280	43012U-A32	41.30
1 x 1	410897-131280	43016U-A36	59.43
1-1/4 x 1-1/4	410898-131280	43020U-A40	85.25
1-1/4 x 1-1/2	410899-131280	43020U-A44	100.70

Female FOR-SEAL® Swivel 90° Long Drop Tube Elbow

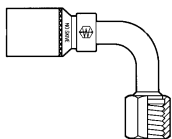

Hose x Tube	Part No.	Vendor No.	Price /Each
1/2 x 1/2	0412967	43008U-A68	\$54.20
1/2 x 5/8	0412968	43008U-A70	52.38
3/4 x 3/4	410900-131280	43012U-A72	41.25

Split Flange 90° Tube Elbow Code 61

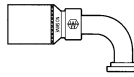

Hose x Flange	Part No.	Vendor No.	Price /Each
1/2 x 1/2	0412970	43008U-G71	\$26.85
1/2 x 1/2	0412971	43008U-G71L32	30.23
1/2 x 3/4	0412972	43008U-G72	24.24
1/2 x 1	0412973	43008U-G76	44.03
3/4 x 3/4	410901-131280	43012U-G72	31.70
3/4 x 3/4	410902-131280	43012U-G72L37	44.60
3/4 x 1	410904-131280	43012U-G76	34.73
3/4 x 1	410905-131280	43012U-G76L31	42.58
1 x 1	410907-131280	43016U-G76	48.33
1 x 1	410909-131280	43016U-G76L46	71.80
1-1/4 x 1-1/4	410913-131280	43020U-G80	67.68
1-1/4 x 1-1/4	410914-131280	43020U-G80L31	88.58
1-1/4 x 1-1/4	410915-131280	43020U-G80L40	93.90
1-1/4 x 1-1/4	410916-131280	43020U-G80L51	108.48
1-1/4 x 1-1/4	410917-131280	43020U-G80L66	110.13
1-1/4 x 1-1/2	410918-131280	43020U-G84	73.55
1-1/2 x 1-1/2	0412975	43024U-G84	80.98
1-1/2 x 1-1/2	0412976	43024U-G84L58	126.80

Split Flange 90° Tube Elbow Code 62

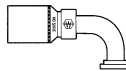

Hose x Flange	Part No.	Vendor No.	Price /Each
1/2 x 1/2	0412985	43008U-D71	\$33.43
3/4 x 3/4	410920-131280	43012U-D72	41.50
3/4 x 1	410921-131280	43012U-D76	47.10
1 x 1	410922-131280	43016U-D76	57.78
1 x 1-1/4	410923-131280	43016U-D80	72.98
1-1/4 x 1-1/4	410924-131280	43020U-D80	77.30
1-1/4 x 1-1/2	410925-131280	43020U-D84	85.20

Split Flange 100° Tube Elbow Code 61

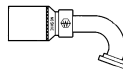

Hose x Flange	Part No.	Vendor No.	Price /Each
1-1/2 x 1-1/2	0412989	43024U-H85	\$109.00

S-Series Hose Ends



Typical Applications: Low, medium and high pressure hydraulic applications calling for corrosion resistance. Marine, logging, mining, etc.

Compatible Hose: H039, H104, H114, H145, H245 and H425

Pressure: Determined by maximum working pressure for hose size.

Material: 316 Stainless Steel

Advantages: Stainless Steel protection from the elements.

Assemble with: T-400-1, T-410-1, T-420-1, T-440-1, T-465-1, T-460, T-462 and ET4000

Male Pipe Rigid

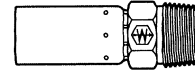

Hose x Pipe	Part No.	Vendor No.	Price /Each
1/4 x 1/4	412000-131280	O4S-104	\$60.68
3/8 x 3/8	412001-131280	O6S-106	74.45
1/2 x 1/2	412002-131280	O8S-108	82.28
3/4 x 3/4	412003-131280	12S-112	117.00
1 x 1	412004-131280	16S-116	140.95

SAE 37° (JIC) Female Swivel

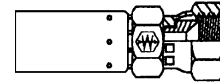

Hose x Pipe	Part No.	Vendor No.	SAE OR JIC	Price /Each
1/4 x 1/4	412006-131280	O4S-604	Both	\$65.40
3/8 x 3/8	412007-131280	O6S-606	JIC	77.93
1/2 x 1/2	412008-131280	O8S-608	Both	91.60
3/4 x 3/4	412010-131280	12S-612	JIC	135.70
1 x 1	412011-131280	16S-616	JIC	191.60
1-1/4 x 1-1/4	412012-131280	20S-620	JIC	389.00

425 N-Series Field Attachable Hose Ends



Typical Application: High pressure hydraulic applications such as construction, farm implement and industrial equipment.

Compatible Hose: H425

Pressure: Determined by maximum working pressure for hose size.

Material: AISI/SAE 12L14 Carbon Steel

Plating: Zinc, yellow dichromate finish

Advantages: Good selection of hose ends. Non-mandrel assembly. Wide variety of applications because of its use with H425 hose.

Assembly Instructions: Due to the high-torque required to assemble larger sizes, it is recommended that 425 N-Series hose ends be assembled with T-300 assembly machine.

1. Lubricate insert threads and I.D. of hose.
2. Measure from end of hose and mark the socket end depth.
3. Screw hose into socket (left-hand thread) to the depth marked on hose.
4. Screw insert into socket until insert touches socket.

Male Pipe Rigid



Hose x Pipe	Part No.	Vendor No.	Price /Each
1/4 x 1/8	412559-131280	42504N-102	\$26.96
1/4 x 1/4	412560-131280	42504N-104	18.97
3/8 x 1/4	412561-131280	42506N-104	10.53
3/8 x 3/8	412562-131280	42506N-106	12.29
1/2 x 3/8	412563-131280	42508N-106	11.67
1/2 x 1/2	412564-131280	42508N-108	10.46
1/2 x 3/4	412565-131280	42508N-112	36.68
3/4 x 3/4	412566-131280	42512N-112	23.58
1 x 1	412567-131280	42516N-116	25.11
1-1/4 x 1-1/4	412568-131280	42520N-120	99.87

425 & 436 N-SERIES FIELD ATTACH. HOSE ENDS

425 N-Series Field Attachable Hose Ends Cont.

FATON | Weatherhead

SAE 37° (JIC) Male Rigid

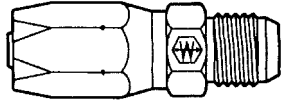

Hose x Tube	Part No.	Vendor No.	Price /Each
1/4 x1/4	412571-131280	42504N-504	\$12.22
1/4 x3/8	412573-131280	42504N-506	30.85
3/8 x3/8	412574-131280	42506N-506	14.25
3/8 x1/2	412575-131280	42506N-508	15.54
1/2 x1/2	412576-131280	42508N-508	13.29

Female Pipe Swivel

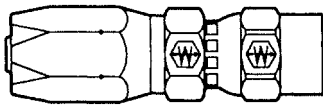

Hose x Pipe	Part No.	Vendor No.	Price /Each
1/2 x1/2	412580-131280	42508N-258	\$16.53
3/4 x3/4	412581-131280	42512N-262	54.41

SAE 37° (JIC) Female Swivel



Hose x Tube	Part No.	Vendor No.	SAE OR JIC	Price /Each
1/4 x1/4	412582-131280	42504N-604	Both	\$8.49
1/4 x5/16	412583-131280	42504N-605	Both	12.57
1/4 x3/8	412584-131280	42504N-606	JIC	8.90
3/8 x3/8	412586-131280	42506N-606	JIC	9.73
3/8 x1/2	412587-131280	42506N-608	Both	10.84
1/2 x1/2	412588-131280	42508N-608	Both	12.64
1/2 x5/8	412589-131280	42508N-610	Both	19.74
3/4 x5/8	412590-131280	42512N-610	Both	26.11
3/4 x3/4	412591-131280	42512N-412	SAE	19.50
3/4 x3/4	412592-131280	42512N-612	JIC	21.96
1 x 1	412594-131280	42516N-616	JIC	28.83
1-1/2 x 1-1/2	412596-131280	42524N-624	JIC	154.29

SAE 37° (JIC) Female Swivel 45° Tube Elbow

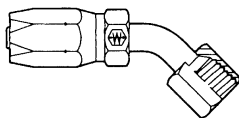

Hose x Tube	Part No.	Vendor No.	SAE OR JIC	Price /Each
1/4 x1/4	412601-131280	42504N-684	Both	\$24.20
3/8 x3/8	412602-131280	42506N-686	JIC	21.20
1/2 x1/2	412603-131280	42508N-688	Both	24.75
1/2 x5/8	412604-131280	42508N-690	Both	27.56
3/4 x3/4	412605-131280	42512N-692	JIC	38.38

SAE 37° (JIC) Female Swivel 90° Tube Elbow

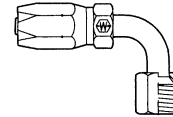

Hose x Tube	Part No.	Vendor No.	SAE OR JIC	Price /Each
1/4 x1/4	412610-131280	42504N-664	Both	\$15.00
3/8 x3/8	412611-131280	42506N-666	JIC	17.27
1/2 x1/2	412612-131280	42508N-668	Both	23.17
1/2 x5/8	412613-131280	42508N-670	Both	29.78
3/4 x3/4	412614-131280	42512N-672	JIC	24.22
1 x 1	412615-131280	42516N-676	JIC	66.95

436 N-Series Field Attachable Hose Ends

FATON | Weatherhead

Typical Application:

Medium pressure hydraulic applications where compatibility may be a problem or where shock hazards exist.

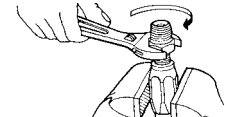
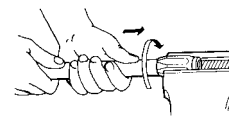

Compatible Hose: H435, H436, H435 Twinline and H436 Twinline

Pressure: Determined by maximum working pressure for hose size and hose end configuration, whichever is lesser.

Material: AISI/SAE 12L14 Carbon Steel

Plating: Zinc, yellow dichromate finish

Advantages: Good selection of hose ends. Non-mandrel assembly.

Assembly Instructions:

1. Lubricate insert threads and I.D. of hose.
2. Screw hose into socket (left-hand thread) until hose bottoms. Back out 1/4 turn.
3. Screw insert into socket until insert touches socket.

Male Pipe Rigid



Hose x Pipe	Part No.	Vendor No.	Price /Each
1/4 x1/4	412475-131280	43604N-104	\$6.73
3/8 x1/4	412476-131280	43606N-104	7.70
3/8 x3/8	412477-131280	43606N-106	10.39
1/2 x1/2	412479-131280	43608N-108	11.88
3/4 x3/4	412480-131280	43612N-112	52.20
1 x 1	412481-131280	43616N-116	37.25

SAE 37° (JIC) Male Rigid

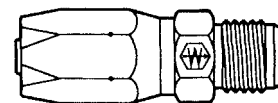

Hose x Tube	Part No.	Vendor No.	Price /Each
1/4 x1/4	412482-131280	43604N-504	\$15.65
1/4 x5/16	412483-131280	43604N-505	18.91
3/8 x3/8	412484-131280	43606N-506	11.38
3/8 x1/2	412485-131280	43606N-508	12.28
1/2 x1/2	412486-131280	43608N-508	13.27
1/2 x5/8	412487-131280	43608N-510	18.73

436 & 104 N-SERIES FIELD ATTACH. HOSE ENDS

436 N-Series Field Attachable Hose Ends



SAE 37° (JIC) Female Swivel

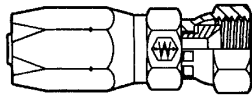

Hose x Tube	Part No.	Vendor No.	SAE OR JIC	Price /Each
1/4 x1/4	412488-131280	43604N-604	Both	\$17.45
1/4 x5/16	412489-131280	43604N-605	Both	7.99
1/4 x3/8	412490-131280	43604N-606	Both	9.97
3/8 x3/8	412492-131280	43606N-606	Both	9.48
3/8 x1/2	412493-131280	43606N-608	Both	26.56
1/2 x1/2	412494-131280	43608N-608	Both	12.77
1/2 x5/8	412495-131280	43608N-610	Both	18.81
3/4 x3/4	412496-131280	43612N-612	Both	51.93
1 x 1	412497-131280	43616N-616	Both	55.25

SAE 37° (JIC) Female Swivel 45° Tube Elbow

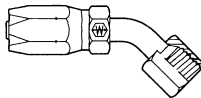

Hose x Tube	Part No.	Vendor No.	Price /Each
1/4 x1/4	412498-131280	43604N-684	\$13.48

SAE 37° (JIC) Female Swivel 90° Tube Elbow

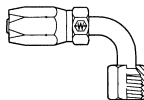

Hose x Tube	Part No.	Vendor No.	Price /Each
3/8 x3/8	412500-131280	43606N-666	\$18.50
1/2 x1/2	412501-131280	43608N-668	24.04

104 N-Series Field Attachable Hose Ends



Typical Applications: High pressure hydraulic applications such as construction, farm implement and industrial equipment.



Compatible Hose: H104

Pressure: Determined by maximum working pressure for hose size and hose end configuration, whichever is lesser.

Material: AISI/SAE 12L14 Carbon Steel

Plating: Zinc, yellow dichromate finish

Advantages: Good selection of hose ends. Non-mandrel assembly. Wide variety of applications because of its use with H104 hose.

Assembly Instructions: Due to the high torque required to assemble larger sizes, it is recommended that 104 N-Series hose ends be assembled with the T-300 assembly machine.

1. Lubricate insert threads and I.D. of hose.
2. Measure from end of hose and mark the socket depth. Use notch on socket.
3. Screw hose into socket (left-hand thread) to the depth marked on hose.
4. Screw insert into socket until insert touches socket.

Male Pipe Rigid



Hose x Pipe	Part No.	Vendor No.	Price /Each
1/4 x1/8	412502-131280	10404N-102	\$19.22
1/4 x1/4	412503-131280	10404N-104	9.73
3/8 x1/4	412504-131280	10406N-104	8.82
3/8 x3/8	412505-131280	10406N-106	12.22
1/2 x3/8	412506-131280	10408N-106	12.48
1/2 x1/2	412507-131280	10408N-108	11.25
3/4 x3/4	412509-131280	10412N-112	38.88
1 x 1	412510-131280	10416N-116	49.82

SAE 37° (JIC) Male Rigid

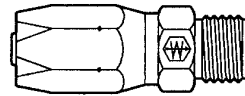

Hose x Tube	Part No.	Vendor No.	Price /Each
1/4 x1/4	412511-131280	10404N-504	\$12.27
3/8 x3/8	412514-131280	10406N-506	13.65
3/8 x1/2	412515-131280	10406N-508	16.90
1/2 x1/2	412516-131280	10408N-508	13.78
1/2 x5/8	412517-131280	10408N-510	16.54
3/4 x3/4	412518-131280	10412N-512	65.63

SAE 37° (JIC) Female Swivel

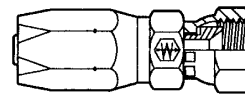

Hose x Tube	Part No.	Vendor No.	SAE OR JIC	Price /Each
1/4 x1/4	412523-131280	10404N-604	Both	\$15.25
1/4 x5/16	412524-131280	10404N-605	Both	13.44
1/4 x3/8	412525-131280	10404N-606	JIC	11.41
3/8 x3/8	412526-131280	10406N-606	SAE	14.22
3/8 x3/8	412527-131280	10406N-606	JIC	10.84
3/8 x1/2	412528-131280	10406N-608	Both	29.39
1/2 x1/2	412529-131280	10408N-608	Both	13.65
1/2 x5/8	412530-131280	10408N-610	Both	16.48
3/4 x5/8	412531-131280	10412N-610	Both	46.15
3/4 x3/4	412532-131280	10412N-612	SAE	58.37
3/4 x3/4	412533-131280	10412N-612	JIC	36.85
3/4 x7/8	412534-131280	10412N-614	JIC	70.25
1 x 1	412535-131280	10416N-616	JIC	67.20

SAE 37° (JIC) Female Swivel 45° Tube Elbow

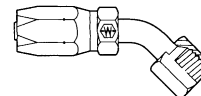

Hose x Tube	Part No.	Vendor No.	SAE OR JIC	Price /Each
1/4 x1/4	412538-131280	10404N-684	Both	\$19.40
3/8 x3/8	412539-131280	10406N-686	JIC	22.53
1/2 x1/2	412540-131280	10408N-688	Both	25.33

104 N-SERIES & 057 B-SERIES ATTACH HOSE ENDS

104 N-Series Field Attachable Hose Ends

FATON | Weatherhead

SAE 37° (JIC) Female Swivel 90° Tube Elbow

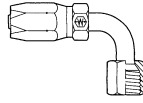

Hose x Tube	Part No.	Vendor No.	SAE OR JIC	Price /Each
1/4 x1/4	412546-131280	10404N-664	Both	\$18.48
3/8 x3/8	412547-131280	10406N-666	JIC	21.70
1/2 x1/2	412548-131280	10408N-668	Both	23.33

SAE 37° (JIC) Female Swivel Long Drop 90° Tube Elbow

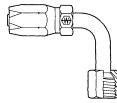

Hose x Tube	Part No.	Vendor No.	SAE OR JIC	Price /Each
1/4 x1/4	412552-131280	10404N-644	Both	\$21.30
3/8 x3/8	412553-131280	10406N-646	JIC	26.55

057 B-Series Field Attachable Hose Ends

FATON | Weatherhead

Typical Application: Low pressure air, fuel and oil applications. Generally used for automotive, light truck, and small engine fuel lines. The fitting is pushed onto the hose and used with a hose clamp.



Compatible Hose: H057, H105*, H115* hose (*H105, H106 and H115 for air applications only.)

Pressure: Determined by maximum working pressure for hose size.

Material: CA360 brass.

Advantages: Easy assembly. Good selection of configurations at reasonable cost.

Assembly Instructions:

1. Slide clamp over hose.
2. Insert barbed end of fitting into hose.
3. Locate band clamp in the middle of 057 B-Series inserts and tighten.

CAUTION: Hose can be cut or damaged if over-tightened.

4. Position wire clamp behind bump on 057 B-Series insert with H057 hose only.

Male Pipe Rigid

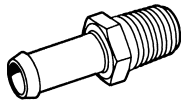

Hose x Pipe	Part No.	Vendor No.	Price /Each
3/16 x1/8	441427-131280	05703B-102	\$1.19
1/4 x1/8	441428-131280	05704B-102	1.29
1/4 x1/4	441429-131280	05704B-104	2.49
5/16 x1/8	441430-131280	05705B-102	1.19
5/16 x1/4	441431-131280	05705B-104	1.94
3/8 x1/8	441432-131280	05706B-102	1.91
3/8 x1/4	441433-131280	05706B-104	2.60
3/8 x3/8	441434-131280	05706B-106	3.71
5/8 x3/8	441435-131280	05710B-106	4.61
5/8 x1/2	441436-131280	05710B-108	7.31
3/4 x1/2	441437-131280	05712B-108	7.32

Inverted Male Connector

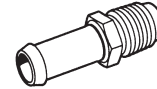

Hose x Tube	Part No.	Vendor No.	Price /Each
5/16 x1/4	441438-131280	05705B-1598	\$3.67
5/16 x5/16	441439-131280	05705B-1560	3.50
5/16 x3/8	441440-131280	05705B-1561	3.90
3/8 x5/16	441441-131280	05706B-1568	2.64
3/8 x3/8	441442-131280	05706B-1570	3.41

SAE 45° Flare Connector

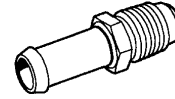

Hose x Tube	Part No.	Vendor No.	Price /Each
3/8 x5/16	441443-131280	05706B-305	\$3.54

Male Pipe Rigid 90° Elbow

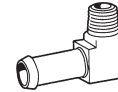

Hose x Pipe	Part No.	Vendor No.	Price /Each
1/4 x1/8	441454-131280	05704B-C02	\$3.47
5/16 x1/8	441455-131280	05705B-C02	2.61
5/16 x1/4	441456-131280	05705B-C04	3.62
3/8 x1/8	441457-131280	05706B-C02	4.15
3/8 x1/4	441458-131280	05706B-C04	3.49
5/8 x3/8	441459-131280	05710B-C06	12.68

Inverted Male Swivel 90° Elbow

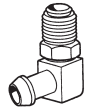

Hose x Tube	Part No.	Vendor No.	Price /Each
5/16 x5/16	441449-131280	05705B-B65	\$5.41
3/8 x5/16	441450-131280	05706B-B65	6.73
3/8 x5/16*	441451-131280	05706B-1416	6.25
3/8 x3/8*	441453-131280	05706B-1417	5.95

*Chrome Plated

Inverted Male Tee Swivel

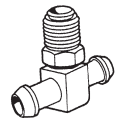

Hose x Tube	Part No.	Vendor No.	Price /Each
3/8 x5/16	441460-131280	05706B-1414	\$6.26
3/8 x3/8*	441461-131280	05706B-1415	7.61

**Hose Clamps for
057 B-Series & Fittings
Available on Page 10-138.**

FIELD ATTACHABLE HOSE ENDS & SPLIT FLANGE KITS

039 K-Series Field Attachable Hose Ends

FATON | **Weatherhead**

Typical Application: Low pressure hydraulic applications and suction lines.

Compatible Hose: H039 and H039H
Pressure: Determined by maximum working pressure for hose size.

Material: 12L14 Carbon Steel
Plating: Zinc, yellow dichromate finish

Assembly Instructions:

1. Lubricate insert and hose I.D.
2. Push hose on barbed stand pipe. Be sure hose is bottomed to clamp retainer.
3. After making sure clamp shoulders will lock in recesses of insert, draw clamps together evenly.

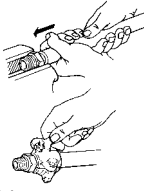

Male Pipe Rigid

Hose x Pipe	Part No.	Vendor No.	Price /Each
3/4 x 3/4	412369-131280	K12N-112	\$35.77
1 x 1	412370-131280	K16N-116	37.65
1-1/2 x 1-1/2	412372-131280	K24N-124	69.27

Male Connector



Hose x Pipe	Part No.	Vendor No.	Price /Each
3/4 x 3/4	412376-131280	IKE12N-112	\$19.49
1 x 1	412377-131280	IKE16N-116	10.33
1-1/4 x 1-1/4	412378-131280	IKE20N-120	16.65
1-1/2 x 1-1/2	412379-131280	IKE24N-124	39.97
2 x 2	412380-131280	IKE32N-132	54.40

Use with H039 and H039H hose only. May be clamped with band or gear-type clamp. Used with suction hose for suction lines or return lines. For low pressure applications only.

Typical Application: Suction and return lines.

Compatible Hose: H039 and H039H

Pressure: Determined by maximum working pressure for hose size.

Material: AISI/SAE 12L14 Carbon Steel

Plating: Zinc, yellow dichromate finish

Assembly Instructions:

1. Cut hose to length. Be sure the cut is square and hose is clean. Trim sharp exposed wire to prevent injury.
2. Slide clamps onto hose.
3. Push fitting into hose. Be sure the hose is bottomed against the atop ring.
4. Position clamps as shown in above diagram. Secure with a screwdriver or wrench.

Note: Band-It style clamps may be used in place of worm gear clamps.

Male Pipe Rigid



Hose x Pipe	Part No.	Vendor No.	Price /Each
3/4 x 3/4	412381-131280	03912K-112	\$6.25
1 x 1	412382-131280	03916K-116	9.25
1-1/4 x 1-1/4	412383-131280	03920K-120	16.00

SAE 37° (JIC) Female Swivel

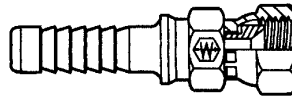

Hose x Tube	Part No.	Vendor No.	Price /Each
3/4 x 3/4	412384-131280	03912K-612	\$8.30
1 x 1	412385-131280	03916K-616	11.83
1-1/4 x 1-1/4	412386-131280	03920K-620	22.53

009 B-Series Field Attachable Hose Ends

Typical Application: Low pressure air, lube and oil Lines.

Compatible Hose: H009

Pressure: Determined by maximum working pressure for hose Size.

Material: CA360 Brass

Advantages: Reusable and easy to assemble. An excellent fitting where low-pressure applications exist and a clamp may get in the way. Good selection of configuration at a reasonable cost.

Label Set: FS-400

Male Pipe Rigid

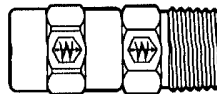

Hose x Pipe	Part No.	Vendor No.	Price /Each
1/4 x 1/8	412341-131280	00904B-102	\$4.99
1/4 x 1/4	412342-131280	00904B-104	3.42

SAE 37° (JIC) Female Swivel

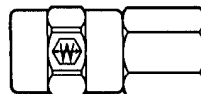

Hose x Tube	Part No.	Vendor No.	Price /Each
1/4 x 1/4	412359-131280	00904B-604	\$4.34

Split Flange Adapter Kits

FATON | **Weatherhead**

Adapter Used with Standard Female Swivel (JIC) End (Code 61):

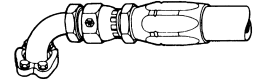

Weatherhead split flange Adapter eliminates the need for special hose ends. Interconnect pumps and valves with SAE flange outlets using low- cost standard hose assemblies to replace equipment hose assembly.

Material: Low-carbon steel

Plating: Zinc, yellow dichromate finish

Pressure: Code 61 - 3000 PSI working pressure (32 Sizes 2500 PSI W.P.)

Label Set: FS-300

Straight Code 61

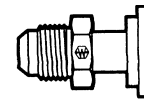

Tube x Flange	Part No.	Vendor No.	Price /Each
1/2 x 1/2	419000-131280	50008	\$22.93
1/2 x 3/4	419001-131280	50008X12	28.53
3/4 x 3/4	419002-131280	50012	13.63
1 x 1	419003-131280	50016	15.75
1 x 1-1/4	419004-131280	50016X20	21.44
1-1/4 x 1-1/4	419006-131280	50020	21.25
1-1/2 x 1-1/2	419007-131280	50024	37.33

90° Elbow Code 61

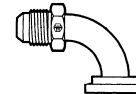

Tube x Flange	Part No.	Vendor No.	Price /Each
1/2 x 1/2	419018-131280	59008	\$26.80
1/2 x 3/4	419019-131280	59008X12	33.73
3/4 x 3/4	419020-131280	59012	18.43
1 x 1	419021-131280	59016	22.80
1 x 1-1/4	419022-131280	59016X20	28.63
1-1/4 x 1-1/4	419024-131280	59020	34.40
1-1/2 x 1-1/2	419025-131280	59024	44.70

Split Flange Kits SAE Standard Pressure Series Code 61

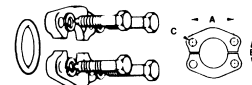

Flange	Part No.	Vendor No.	Price /Each
1/2	419027-131280	SFK-8	\$10.25
3/4	419028-131280	SFK-12	9.55
1	419029-131280	SFK-16	11.38
1-1/4	419030-131280	SFK-20	14.58
1-1/2	419031-131280	SFK-24	19.58
2	419032-131280	SFK-32	22.25

HYDRAULIC PUMPS & PUMP ACCESSORIES

Hydraulic Accessories

Hydraulic Pumps

POWER TEAM®

Hydraulic Hand Pumps

10,000 PSI. capacity. Choice of single- or 2-speed versions to power single acting cylinders. Up to 2-1/2" gallon capacity available upon request. Internal relief valve. Single-acting cylinders (pump includes 2-way valve).



Note: Oil capacity and usable oil capacity are in cubic inches.

Part No.	Model No.	Stage	Oil Capacity	Usable Oil Capacity	Weight (lbs)	Price /Each
0489636	P12	1	12.0	9.0	5.7	\$299.75
0489637	P19	1,2	24	20.0	6.6	325.50
0489638	P55	1	55.0	45.0	15.8	324.90
0489639	P59	1,2	55.0	45.0	17.2	385.50
0489640	*P157	1,2	152.0	137.0	26.7	625.00
0489641	**P159	1,2	152.0	137.0	26.2	549.00

*Low speed shifts to high at 1400 PSI.

**Low speed shifts to high at 325 PSI.

Hand Operated Pump Set

Matched hydraulic system components, adapters and hydraulic spreader, contained in a rugged carrying and storage case. Portable sets are ideal for pushing, pulling, lifting, lifting, straightening, or clamping at remote job sites. Includes hand operated pump.

Contents:

- Hydraulic spreader
- Hand pump
- 10,000 psi hyd. gauge
- Tee adapter
- Hose & coupler assembly
- 90° V base
- Threaded coupler
- Serrated saddle
- Flat base
- Extension rod - 5" length
- Extension rod - 10" length
- Extension rod - 18" length
- Cylinder support base
- Cylinder assembly, 10 ton, 6 1/8" stroke
- Storage box



Part No.	Vendor No.	Oil Capacity	Weight (lbs)	Price /Each
0489628	IM10H	10 Tons	89	\$1750.00

Air/Hydraulic Pump

0489642: Ideal for powering single acting cylinders and tools. For use with cylinder type: single-acting. Air supply required: 40-120 PSI.



0498644: Proven reliability, 98 cubic inches oil usable. Hand or foot activated. For use with cylinder type: single-acting. Air supply required: 40-120 PSI.



Note: Oil capacity and usable oil capacity are in cubic inches.

Part No.	Model No.	Oil Capacity	Usable Oil Capacity	Weight	Price /Each
0489642	PA9	35	33.5	15 lbs.	\$599.00
0489644	PA6	105	98	14 lbs.	649.00

Pump Accessories

POWER TEAM®

Hoses and Couplers



0489675 and 0489676



0489677



0489678



0489679

NPT Size	Part No.	Vendor No.	Description	Price /Each
3/8"	0489675	9754	6' Rubber Hose, 1/4" ID with 0489679 and Dust Cap	\$110.75
3/8"	0489676	9764	6' Polyurethane Hose, 1/4" ID with 0489679 and Dust Cap	149.75
3/8"	0489677	9795	Complete Coupler with Dust Caps	58.90
3/8"	0489678	9796	Female Half Coupler	35.75
3/8"	0489679	9798	Male Half Coupler	27.75

IN OUR PEOPLE AND OUR PRODUCTS

POWER TEAM

INTEGRITY

WITH A NAME LIKE POWER TEAM IT'S EASY TO SEE WHY OUR PRODUCTS PERFORM IMPRESSIVE TASKS. FROM OUR GLOBAL DISTRIBUTOR NETWORK AND SERVICE CENTERS TO OUR PERSONAL ATTENTION TO QUALITY. EVERY ASPECT OF OUR TEAM CARES ABOUT THE END RESULT. OUR PRODUCTS WILL ALWAYS HAVE THAT EDGE, THE PEOPLE QUALITY

SPX FLUID POWER
Your Global Force In Fluid Power

•Hydraulic Valves •High Force Tools
 •Jacks •Hydraulic Cylinders
 •Hydraulic Power Units

HIGH PRESSURE HYDRAULIC VALVES & ACCESS.

Misc. Hydraulic Accessories

POWER TEAM®

Hydraulic Spreader



Part No.	Model No.	Cyl. Capacity	Weight (lbs)	Price /Each
0489649	HS2000	1 ton	4.8	\$259.00

Hydraulic Mini Jack

Five tons of power in the palm of your hand, with just over 2.5" of clearance needed. Weighs only 4.2 lbs.



Part No.	Model No.	Price /Each
0489648	9105A	\$149.00

General Purpose Cylinders



25 Tons



10 Tons



5 Tons

Capacities of 5 to 100 tons, stroke length of 1" to 16". Single-acting, spring return. The most popular cylinders are listed below.

Aluminum bronze bearing reduces wear caused by off-center loads. Maximum sized springs speed piston return and increase spring life. Solid steel cylinder body for durability.

Part No.	Cyl. Capacity (tons)	Stroke (in)	Model No.	Retracted Ht. (in)	Ext. Ht. (in)	Price /Each
0489629	5	3.25	C53C	6.50	9.75	\$275.35
0489630	5	5.25	C55C	8.50	13.75	279.00
0279150	10	1	C101C	3.625	4.625	299.00
0489656	10	2.125	C102C	4.75	6.875	299.00
0489631	10	4.125	C104C	6.75	10.875	329.00
0489632	10	6.125	C106C	9.75	15.875	365.00
0489633	25	4.00	C254C	8.50	12.50	525.00
0489634	25	6.25	C256C	10.75	17.00	597.00
0489635	55	6.25	C556C	11.125	17.375	1026.00

Ask your local Fastenal representative for other sizes and custom made cylinders.

"Low Profile" Cylinders

Ideal for confined areas from 15/8" to 4" clearance. Single-acting, spring-return. 5 - 150 ton capacity. Please see your local Fastenal representative for additional sizes and custom made cylinders.



Part No.	Cyl. Capacity (tons)	Stroke (in)	Model No.	Retracted Ht. (in)	Ext. Ht. (in)	Price /Each
0279149	20	7/16	RLS200	2	2-7/16	\$601.52

Nut Splitter

"Dial in" feature on HNS150 makes adjustment of splitter simple, without the worry of damaging the bolt. Specially designed "tool steel" cutter blade penetrates the nut to the precise point where it cracks, stopping short of the bolt threads. Nut splitter features a dramatically improved cutter blade with an 800% greater resistance to chipping and breaking over previous models.



Part No.	Vendor No.	Capacity	Price /Each
0489650	HNS150	15 tons	\$1098.00

High Pressure Hydraulic Valves

HYDAC

In-line Flow Valves

In-Line Needle Valves

- Phosphate coated carbon steel housing
- FPM (Viton Seals)
- Slotted control spindle for precise and linear flow adjustments
- Graduated knob and color coded spindle for accurate flow control
- Guided poppets for smoother chatter-free operation
- Operating Pressure: 5000 PSI



Size	Vendor No.	Part No.	Price /Each
1/8"	00705006	0426981	\$30.10
1/4"	00705018	0426982	31.29
3/8"	00705030	0426983	39.61
1/2"	00705042	0426984	43.62
3/4"	00705054	0426985	58.96
1"	00705066	0426986	122.16
1-1/4"	00705078	0426987	205.70

In-Line Flow Control Valves

- Phosphate coated carbon steel housing
- FPM (Viton Seals)
- Slotted control spindle for precise and linear flow adjustments
- Graduated knob and color-coded spindle for accurate flow control
- Guided poppets for smoother chatter-free operation
- Temperature Range: -4°F to 212°F
- Cracking Pressure: 7 PSI
- Operating Pressure: 5000 PSI



Size	Vendor No.	Part No.	Price /Each
1/4"	00705518	0426974	\$39.55
3/8"	00705530	0426975	45.98
1/2"	00705542	0426976	52.82
3/4"	00705554	0426977	64.33
1"	00705566	0426978	165.63

HIGH PRESSURE HYDRAULIC VALVES & IND. HOSE

Industrial Hose

High Pressure Hydraulic Valves Cont.



In-Line Check Valves

- Phosphate coated carbon steel housing
- Metal to metal seal design
- Temperature Range: -4°F to 212°F
- Cracking Pressure: 7 PSI
- Operating Pressure: 5000 PSI



Size	Vendor No.	Part No.	Price /Each
1/8"	00705827	0426965	\$19.59
1/4"	00705830	0426966	24.26
3/8"	00705833	0426967	25.56
1/2"	00705836	0426968	34.53
3/4"	00705839	0426969	42.91
1"	00705842	0426970	69.58
1-1/4"	00705845	0426971	120.41
1-1/2"	02057126	0426972	155.53
2"	02055684	0426973	255.14

Two Way High Pressure Ball Valves

- Full port, unrestricted flow
- Positive seal based on the "floating ball" principle
- Phosphate coated steel housing, polyacetal ball seals, and fluorocarbon seals
- KHB-Block Housing - 1/4"-1"
- KHM-Forged Housing - 1-1/4"-2"
- Temperature Range: -4°F to 220°F
- Operating Pressure: 5000 PSI



Size	Vendor No.	Part No.	Price /Each
1/4"	02060280	0426989	\$47.63
3/8"	02060281	0426990	53.77
1/2"	02060282	0426991	62.98
3/4"	02060283	0426992	93.54
1"	02060284	0426993	112.89
1-1/4"	02060285	0426994	202.50
1-1/2"	02060286	0426995	273.47

Industrial Hose



Bulk Red Rubber Air Hose Products

Multi-purpose air and water hose. Industrial, construction, and agricultural applications. 4:1 safety factor.



Part No.	Hose Lgth. (ft)	Description	Price /Ft
400403	500'	1/4" ID, 300 PSI	\$0.63
400404	500'	3/8" ID, 300 PSI	0.63
400405	500'	1/2" ID, 300 PSI	1.05
400406	500'	3/4" ID, 250 PSI	1.41
400407	450'	1" ID, 250 PSI	2.13
400408	400'	1-1/4" ID, 200 PSI	4.00
400409	300'	1-1/2" ID, 200 PSI	4.55

Heavy-Duty Rubber Air Hose Assemblies

Rubber multi-purpose air and water hose assembly. Industrial, construction, and agricultural applications. Hose is coupled using male x male NPT fittings. 4:1 safety factor.



Part No.	Description	Price /Each
400414	1/4" x 50 ft, 300 PSI, 1/4" NPT fittings	\$42.35
400415	1/4" x 100 ft, 300 PSI, 1/4" NPT fittings	79.90
400416	3/8" x 50 ft, 300 PSI, 1/4" NPT fittings	47.44
400417	3/8" x 100 ft, 300 PSI, 1/4" NPT fittings	75.58
400418	1/2" x 50 ft, 300 PSI, 1/2" NPT fittings	68.58
400419	1/2" x 100 ft, 300 PSI, 1/2" NPT fittings	126.75
400420	3/4" x 50 ft, 250 PSI, 3/4" NPT fittings	86.10
400421	3/4" x 100 ft, 250 PSI, 3/4" NPT fittings	158.95

It's all Goodyear, It's all Here.

Whatever the application, Goodyear has the answer in our full line of industrial hose including air, steam, food transfer, water discharge, petroleum, multipurpose water hose, washdown hose and others.

Contact Fastenal today about Goodyear's full line of industrial hose products.

©2007 The Goodyear Tire & Rubber Company.



Industrial Hose



PVC Bulk Air Hose

Blue bulk multi-purpose PVC air and water hose. Industrial, construction, and agricultural applications. Rated at 300 PSI working pressure and non-conductive.



Part No.	Description	Price /Ft
400400	1/4" ID, 300 PSI, 750 Foot Reel	\$0.36
400401	3/8" ID, 300 PSI, 750 Foot Reel	0.43
400402	1/2" ID, 300 PSI, 750 Foot Reel	0.55

PVC Air Hose Assemblies

Lightweight PVC multi-purpose air and water hose assembly. Industrial, construction, agricultural hand sprayers, and mild chemical applications. Hose is coupled using male x male 1/4" NPT fittings and is rated at 300 PSI working pressure.



Part No.	Description	Price /Each
400410	1/4" x 50 ft, 300 PSI Hose Assemblies	\$29.25
400411	1/4" x 100 ft, 300 PSI Hose Assemblies	45.49
400412	3/8" x 50 ft, 300 PSI Hose Assemblies	31.66
400413	3/8" x 100 ft, 300 PSI Hose Assemblies	53.55

Jack Hammer Air Hose Assembly

Ideal for the transfer of air, water, and mild chemicals. Specifically designed for the construction industry. Coupled with Chicago/Universal air couplings and band clamps.



Part No.	Description	Price /Each
400422	3/4" x 50 ft, 250 PSI, Universal Couplings	\$83.40

Note: Most popular Chicago/Universal Fittings are part numbered on page 10-135.

Gorilla Air Hose

Premium quality multi-purpose hose used in a wide range of applications in factories, construction, agricultural, quarries, mines, railroads, the oil & gas industry, and shipbuilding. The tube is high oil-resistant, the cover is super abrasion-resistant, and the hose is non-conductive. Rated at 500 PSI working pressure with a 4:1 safety factor.



Part No.	Description	Price /Foot
0491614	3/8" Gorilla Air Hose	\$2.73
0491615	1/2" Gorilla Air Hose	3.77
0491616	3/4" Gorilla Air Hose	4.95
0491617	1" Gorilla Air Hose	7.45
0491618	1-1/4" Gorilla Air Hose	11.92
0491619	1-1/2" Gorilla Air Hose	13.71
0491620	2" Gorilla Air Hose	14.31



Kuriyama

Clear Vinyl Tubing (Hose)

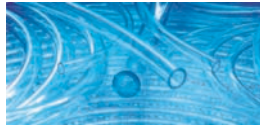

Part No.	Description	Price /Foot
0431130	1/4" x 100 ft, 55 PSI	\$0.16
0431131	5/16" x 100 ft, 50 PSI	0.22
0431132	3/8" x 100 ft, 45 PSI	0.22
0431133	1/2" x 100 ft, 30 PSI	0.27
0431134	1/2" x 100 ft, 45 PSI	0.59
0431135	5/8" x 100 ft, 35 PSI	0.62
0431136	5/8" x 100 ft, 40 PSI	0.70
0431137	3/4" x 100 ft, 35 PSI	0.87
0431138	3/4" x 100 ft, 40 PSI	1.36
0431139	7/8" x 100 ft, 30 PSI	1.09
0431141	1" x 100 ft, 25 PSI	1.09
0431143	1-1/4" x 50 ft, 20 PSI	1.30
0431145	1-1/2" x 50 ft, 30 PSI	2.45
0431147	2" x 50 ft, 35 PSI	4.28



ADVANCED TECHNOLOGY PRODUCTS

Clear PVC Tubing (Hose)



Part No.	Vendor No.	I.D.	O.D.	Coil Lgth.	Price /Foot
400426	PVC1438-100	1/4"	3/8"	100'	\$0.21
400429	PVC3812-100	3/8"	1/2"	100'	0.29
400430	PVC38-100	3/8"	9/16"	100'	0.47
400431	PVC1258-100	1/2"	5/8"	100'	0.39
400432	PVC12-100	1/2"	3/4"	100'	0.72
400433	PVC58-100	5/8"	7/8"	100'	0.85
400434	PVC34-100	3/4"	1"	100'	0.95
400435	PVC1-100	1"	1-1/4"	100'	1.25



Clear PVC Nylon Reinforced Hose

Versatile, lightweight, reinforced tubing that can be used for the food and beverage, general air, pharmaceutical, cosmetics, computer components, textile mills, and air-actuated equipment industries. Hose conforms to FDA, USDA, NSF61, and 3A standards.

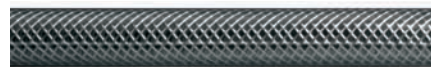

Part No.	Description	Price /Ft
400436	1/4" x 300 ft, 250 PSI	\$0.38
400437	5/16" x 300 ft, 250 PSI	0.72
400438	3/8" x 300 ft, 250 PSI	0.61
400439	1/2" x 300 ft, 200 PSI	0.86
400440	5/8" x 300 ft, 200 PSI	1.19
0431125	3/4" x 200 ft, 150 PSI	1.42
0431126	1" x 100 ft, 125 PSI	2.02
0431127	1-1/4" x 100 ft, 100 PSI	2.98
0431128	1-1/2" x 100 ft, 100 PSI	3.68
0431129	2" x 100 ft, 75 PSI	5.47

Push-On Style Low-Pressure Hose

For use with air tools. Will handle air, water, oil, etc and is used with push-on style fittings at working pressure of up to 250 PSI.



Part No.	Description	Price /Ft
400487	1/4" ID, 250 PSI, Black	\$0.95
400488	3/8" ID, 250 PSI, Black	1.09
400489	1/2" ID, 250 PSI, Black	1.69
0400000	5/8" ID, 250 PSI, Black	2.78
0400001	3/4" ID, 250 PSI, Black	3.58

PVC Suction Hose

Used for water suction and discharge service in construction and septic tank cleaning operations. For general and agricultural applications where mild chemical resistance is needed.

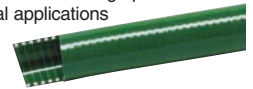

Part No.	Description	Price /Ft
400463	1-1/2" ID, Heavy Duty, Solid Green	\$1.78
400464	2" ID, Heavy Duty, Solid Green	2.61
400465	3" ID, Heavy Duty, Solid Green	4.72
400466	4" ID, Heavy Duty, Solid Green	7.70



PVC Suction Hose Assemblies



Part No.	Description	Price /Each
400469	2 x 20 ft. coupled MxF aluminum fittings	\$81.25
400470	2 x 25 ft. coupled MxF aluminum fittings	95.50
400471	3 x 20 ft. coupled MxF aluminum fittings	165.00
400472	3 x 25 ft. coupled MxF aluminum fittings	192.50
400473	4 x 20 ft. coupled MxF aluminum fittings	255.00

Fastenal branch personnel please Sold Request 1 = 1 assembly.

PVC Discharge Hose

Light duty water discharge hose for use in mining, construction, agricultural, and marine service applications.



Part No.	Description	Price /Ft
400475	1-1/2" PVC Hose	\$0.67
400476	2" PVC Hose	1.24
400477	3" PVC Hose	1.30
400478	4" PVC Hose	1.92

Fastenal Branch Personnel: Please Sold Request number of feet (25, 100, and 300 feet).

INDUSTRIAL HOSE

Industrial Hose Cont.

Industrial Hose



PVC Discharge Hose Assemblies



Part No.	Description	Price /Each
400479	1-1/2 x 25 ft. coupled MxF aluminum fittings	\$33.99
400480	2 x 25 ft. coupled MxF aluminum fittings	42.25
400481	3 x 25 ft. coupled MxF aluminum fittings	75.00
400482	4 x 25 ft. coupled MxF aluminum fittings	99.50

Fastenal branch personnel please Sold Request
1 = 1 assembly



Goodyear Virsiflo 125 Discharge Hose

All rubber water discharge hose for medium duty water discharge service.

Lay flat Construction



Part No.	Description	Price /Foot
0491630	1-1/2" Versiflo 125	\$3.31
0491631	2" Versiflo 125	3.73
0491632	3" Versiflo 125	5.36

Goodyear Spiraflex Aggie PVC Suction\Discharge Hose

For use in general purpose water suction in industrial, agricultural, and construction applications.



Part No.	Description	Price /Foot
0491626	1-1/2" PVC Suction Hose	\$1.56
0491627	2" PVC Suction Hose	2.18
0491628	3" PVC Suction Hose	4.10
0491629	4" PVC Suction Hose	6.55

Rubber Suction\Discharge Hose

General purpose water suction and discharge hose. For applications that see medium or heavy duty service found in construction or agricultural industries.

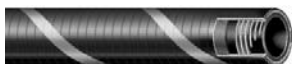

Part No.	Description	Price /Foot
0491621	1-1/2" Rubber Water Suction Hose	\$5.95
0491622	2" Rubber Water Suction Hose	6.63
0491623	3" Rubber Water Suction Hose	9.73

Stainless Steel and Aluminum Cam & Groove fittings are available on page 10-135.

Goodyear Nutriflo PVC Food Transfer Hose

Clear PVC S&D hose that can handle almost every type of dry bulk food material or liquid in gravity flow and vacuum service. Conforms to USDA, FDA, 3A, and NSF 61.



Part No.	Description	Price /Foot
0491654	1" Clear PVC Hose	\$2.58
0491655	1-1/4" Clear PVC Hose	3.31
0491656	1-1/2" Clear PVC Hose	3.64
0491657	2" Clear PVC Hose	5.36
0491658	3" Clear PVC Hose	10.09

Contractor's Water Hose Assemblies

Industrial, construction, and agricultural water discharge applications where general service water hose is needed. Hose is coupled using male x female standard garden hose fittings.



Part No.	Description	Price /Each
400461	3/4" x 25 ft, 150 PSI, Black	\$29.81
400462	3/4" x 50 ft, 150 PSI, Black	57.43

Fastenal Branch Personnel: Please Sold Request (1=1 assembly).

Pressure Washer Hose Assemblies

Used on pressure washer machines with working pressures up to 3000 PSI. Coupled using male rigid pipe x male swivel pipe fittings with black bend restrictors on each end.



Part No.	Description	Price /Each
400490	1/4" x 50 ft, 3000 PSI, Black	\$125.47
400491	3/8" x 50 ft, 3000 PSI, Black	143.81
400492	1/2" x 50 ft, 3000 PSI, Black	177.93

Fastenal Branch Personnel: Please Sold Request (1=1 assembly).

Food Washdown Hose

Used for hot water applications (up to 200°F) in clean-up service, food processing plants, dairies, meat packing houses, bottling plants, breweries, canneries, and creameries. Cover is super abrasive-resistant and oil resistant, and incorporates Microban's anti-microbial built in protection.



Part No.	Description	Price /Foot
0491635	1/2" Fortress 300 with Microban	\$3.60
0491636	3/4" Fortress 300 with Microban	4.87

Goodyear Tapered End Washdown Hose (Lengths)

Used in water discharge applications found in paper mills and other industrial plants where flexibility and the need for a built-in integral rubber nozzle end are important.



Part No.	Description	Price /Each
0491662	3/4" x 50 ft. Washdown Hose	\$292.50
0491663	1" x 50 ft. Washdown Hose	370.00

Steam Hose

Rugged construction used for all around steam service in chemical plants, refineries, shipyards, and demanding industrial service. Recommended for 250 PSI saturated steam service up to 406°F.



Part No.	Description	Price /Foot
0491640	1/2" Flexsteel Steam Hose	\$6.02
0491641	3/4" Flexsteel Steam Hose	6.83
0491642	1" Flexsteel Steam Hose	10.08
0491643	1-1/4" Flexsteel Steam Hose	13.24
0491644	1-1/2" Flexsteel Steam Hose	16.23
0491645	2" Flexsteel Steam Hose	20.33

Coupled Gas and Petroleum Hose (Lengths)

Multi-use hose assembly used to dispense gasoline, grease, kerosene, and petroleum oils from farm and barrel type pumps. Used for agricultural, construction, and industrial service where UL approval is not required. Coupled using 3/4" male x male NR-B1 one-time fittings.



Part No.	Description	Price /Each
0491650	3/4" x 12 ft. Coupled Gas Hose	\$23.17
0491651	3/4" x 14 ft. Coupled Gas Hose	26.15
0491652	1" x 12 ft. Coupled Gas Hose	35.11
0491653	1" x 14 ft. Coupled Gas Hose	40.42

Chemical Transfer Hose

Will handle the majority of today's industrial chemicals in pressure, gravity flow, or suction service. Contains a cross link polyethylene tube.



Part No.	Description	Price /Foot
0400002	1/2" I.D. x .097" O.D., 150 PSI, Green	\$10.78
0400003	3/4" I.D. x 1.23" O.D., 150 PSI, Green	12.65
0400004	1" I.D. x 1.47" O.D., 150 PSI, Green	12.87
0400006	1-1/2" I.D. x 2.03" O.D., 150 PSI, Green	14.93
0400007	2" I.D. x 2.61" O.D., 150 PSI, Green	16.05

Goodyear Plicord Flexwing

For use in tank and in-plant operations to transfer gasoline, oil, and other petroleum based products that have up to 50% aromatic content. Designed for pressure gravity flow or full suction service.



Part No.	Description	Price /Foot
0491646	1-1/2" Flexwing Petroleum Transfer	\$7.42
0491647	2" Flexwing Petroleum Transfer	8.33
0491648	3" Flexwing Petroleum Transfer	12.05
0491649	4" Flexwing Petroleum Transfer	15.38

Steel Shot and Sand Blasting Hose

Standard duty hose for steel shot or sand blasting in cleaning or finishing metal, stone, or other surfaces.



Part No.	Description	Price /Foot
0491659	3/4" Blasting Hose	\$5.23
0491660	1" Blasting Hose	6.28
0491661	1-1/4" Blasting Hose	7.54

SAFETY AND SPRING DRIVEN HOSE REELS

Hose Reels

Safety Series Hose Reels



The EZ-Coil™ Rewind Safety System controls and eliminates the high-speed recoil associated with conventional spring driven reels. The slower, controlled rewind action of this reel greatly increases operator safety, as well as the safety of the people and property in the surrounding area.

Features

- "CPC™ Powder Coat Blue Finish" powder coat paint
- Eight-position locking ratchet secures reel at desired length
- Super Hub dual axle support on Heavy Duty Models
- 1/4" plate steel supports post and mounting plate
- Full flow swivel joint
- 8 position adjustable arm guide
- Super Hub dual axle support system on Heavy Duty models
- 1" oil-lite self-lubricating bearing
- 2-Year manufacturer's limited warranty
- Made in the USA

Performance Safety Reels

Operating Pressure (PSI)	Hose I.D.	Part No.	Vendor No.	Hose Lgth. (ft)	Ship Wt. (lbs)	Price /ea
300	3/8"	0401448	EZ-P-LP-350	50'	51	351.59:
2500	1/2"	0401451	EZ-P-MP-425	25'	48	455.37:
5000	1/4"	0401453†	EZ-P-HP-125	25'	48	460.38:

*† Grease/Hydraulic oil reels

Super Hub Safety Reels

Operating Pressure (PSI)	Hose I.D.	Part No.	Vendor No.	Hose Lgth. (ft)	Ship Wt. (lbs)	Price /ea
300	3/8"	0401457	EZ-SH-350	50'	60	\$387.53:
300	1/2"	0401459	EZ-SH-450	50'	67	434.75:
3000	1/2"	0401462	EZ-MP-450	50'	69	554.18:
5000	1/4"	0401464	EZ-HP-150	50'	68	565.17:

Supreme Duty Safety Reels - Full Frame

Operating Pressure (PSI)	Hose I.D.	Part No.	Vendor No.	Hose Lgth. (ft)	Ship Wt. (lbs)	Price /ea
300	3/8"	0401468	EZ-TSH-3100	100'	97	\$621.54:
300	1/2"	0401471	EZ-TSH-4100	100'	102	638.64:
250	3/4"	0401473	EZ-TSH-550	50'	94	600.42:

Performance Hose Reels

These compact reels are designed to handle air, water, oil and grease applications where shorter lengths of hose are required. Available in pressure ratings of 300, 2500, 3000 and 5000 PSI.

Features

- Steel construction with powder coat finish
- Multi-position locking ratchet
- Adjustable guide arm for various mounting positions
- Adjustable solid rubber hose stop
- Lubricated containerized spring motor
- 2-Year manufacturer's limited warranty
- Made in the USA



Operating Pressure (PSI)	Hose I.D.	Part No.	Vendor No.	Hose Lgth. (ft)	Ship Wt. (lbs)	Price /ea
300	1/4"	0401443	P-LP-125	25'	32	\$208.58:
300	1/4"	7059224	P-LP-135	35'	28	185.68:
300	1/4"	0401444	P-LP-150	50'	46	280.89:
300	3/8"	0401445	P-LP-325	25'	35	213.05:
300	3/8"	0401446**	P-LPL-325	25' Capacity	35	288.62:
300	3/8"	0401447	P-LP-350	50'	51	260.24:
300	3/8"	0401454**	P-LPL-350	25' Capacity	39	249.45:
300	1/2"	7059226	P-LP-425	25'	44	220.56:
300	1/2"	7059228	P-LP-450	50'	48	296.47:
3000	3/8"	0401449	P-MP-325	25'	47	332.74:
2500	1/2"	0401450*†	P-MP-425	25'	48	390.08:
5000	1/4"	0401452*†	P-HP-125	25'	48	395.10:

** Indicates models without hose

*† Grease/Hydraulic oil reels

Super Hub Hose Reels

These reels offer a larger chassis and a double supported axle for extra strength and stability. This design allows for longer lengths of hose making the reel suitable for air, water, oil, grease, gas, and other heavy fluids.

Features

- High-quality steel construction
- 1" solid steel axle with 1" precision bearings and Super Hub dual axle support system
- Multi-position locking ratchet
- Adjustable guide arm for various mounting positions
- Durable "CPC™ Powder Coat Blue Finish"
- 2-year manufacturer's limited warranty
- Made in the USA



Operating Pressure (PSI)	Hose I.D.	Part No.	Vendor No.	Hose Lgth. (ft)	Ship Wt. (lbs)	Price /ea
300	3/8"	0401455**	SHL-N-350	50' Capacity	52	\$291.47:
300	3/8"	0401456	SH-N-350	50'	60	332.56:
300	3/8"	7059176	SH-N-3100	100'	71	443.17:
300	1/2"	0401458	SH-N-450	50'	67	364.16:
300	1/2"	7059185**	SHL-N-450	50' Capacity	46	260.57:
3000	3/8"	0401460	MP-N-350	50'	67	489.24:
3000	1/2"	0401461	MP-N-450	50'	69	499.19:
5000	1/4"	0401463*†	HP-N-150	50'	68	509.14:
5000	3/8"	0401465*†	HP-N-350	50'	71	540.25:

** Indicates models without hose

*† Grease/Hydraulic oil reels

HAND CRANK AND TRUCK MOUNT HOSE REELS

Hose Reels Cont.

Compact Hand Crank Hose Reels



Your Reel Source



Hose Reels

This reel is a compact hose reel built to perform at working pressures up to 4,000 PSI. Features include: direct handcrank rewind design, handles temperatures from -20 ° F to 225 ° F, heavy-duty steel construction, CPC™ powder coat finish, adjustable hand brake and a 2-Year manufacturer's limited warranty. Hose not included. Made in the USA.

- Lightweight, compact, versatile reels that perform at working pressures up to 4,000 PSI
- Save time and effort while increasing the safety of your work environment
- The sturdy "U" shaped frame and all steel construction makes this one tough little reel

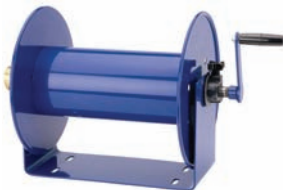

Operating Pressure (PSI)	Hose I.D.	Part No.	Vendor No.	Hose Capacity	Ship Wt. (lbs)	Price /ea
4000 PSI	3/8"	0401478	112-3-100	100'	18.5	\$155.67:
4000 PSI	3/8"	7059188	112-3-150	150'	21	144.65:
4000 PSI	1/2"	0401479	117-4-225	225'	33	186.78:
4000 PSI	3/8"	7059189	117-3-250	250'	30	155.93:
4000 PSI	3/8"	7059190	117-3-400	400'	33	161.06:
4000 PSI	3/8"	7059191	117-3-550	550'	35	166.19:
4000 PSI	1/2"	7059238	112-4-75	75'	21	153.88:
4000 PSI	3/4"	7059193	117-5-100	100'	35	190.81:

All Parts: Hose not included

Swivel Compact Hand Crank Hose Reel

- Swivel on demand in the direction your work takes you and locks in eight different positions as desired
- Lightweight, compact, and versatile with a working pressure up to 4,000 PSI
- The "U" shaped base and hose control bar together add strength and rigidity while keeping the hose from slipping off the side discs

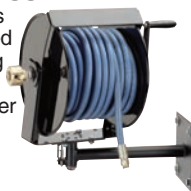

Operating Pressure (PSI)	Hose I.D.	Part No.	Vendor No.	Hose Capacity	Ship Wt. (lbs)	Price /ea
7059112	SM17-3-250	4000 PSI	3/8"	250'	30	\$151.83:

Hose not Included.

Compact Hand Carry/Crank Hose Reels

- Perfect for carrying the extra long lengths of hose to the job site
- Lightweight, compact and versatile with working pressures up to 4,000 PSI
- The hose control bar prevents the hose from slipping off the side discs and makes it easy to grab and go



Operating Pressure (PSI)	Hose I.D.	Part No.	Vendor No.	Hose Capacity	Ship Wt. (lbs)	Price /ea
7058984	112-3-100-CM	4000 PSI	3/8"	100'	19	\$154.91:
7058988	117-4-225-DM	4000 PSI	1/2"	225'	31	229.79:

All Parts: Hose not Included

Stainless Steel Compact Hand Crank Hose Reel

- Constructed of high quality electro-polished stainless steel
- Offers clean, non-corrosive performance in applications that require it, such as food and chemical processing marinas, and anywhere that rust, corrosion, and contamination thrive.
- Stainless steel fluid paths are also available at special request



Operating Pressure (PSI)	Hose I.D.	Part No.	Vendor No.	Hose Capacity	Ship Wt. (lbs)	Price /ea
7059035	112-4-75-SS	4000 PSI	1/2"	75'	21	\$511.91:

Hose not Included

Competitor Series Hand Crank Hose Reels

This reel's features include: low profile riser, open drum slot for even hose wraps, solid steel crank handle, high-quality steel construction, CPC™ powder coat, one piece welded steel "A" frame construction, positive gear drive, and a 2-year manufacturer's limited warranty. Hose not included. Made in the USA.



Part No.	Vendor No.	Operating Pressure (PSI)	Hose I.D.	Hose Capacity	Ship Wt. (lbs)	Price /ea
0401481	1125-4-450	4000	1/2"	100'	52	\$229.16:
7059263	1125-4-100	3000 PSI	1/2"	100'	36	199.02:
7059140	1125-5-100	3000 PSI	3/4"	100'	42	250.31:
7059141	1125-5-175	3000 PSI	3/4"	175'	50	257.49:
0401480	1125-4-200	4000	1/2"	200'	38	218.89:
7059143	1125-5-250	3000 PSI	3/4"	250'	59	262.62:

All Parts: Hose not Included

Large Capacity Hand Crank Hose Reels

- Designed to handle long lengths of large diameter hose for increased volume delivery.
- Exclusive low profile outlist riser and open drum design provide a non-crimping, flat smooth hose wrap
- The sturdy one piece all welded "A" frame base provides exceptional strength to handle the extra weight without sacrificing performance, even in demanding mobile applications
- Hose not included.



Part No.	Vendor No.	Operating Pressure (PSI)	Hose I.D.	Hose Capacity	Ship Wt. (lbs)	Price /ea
0401482	1185-2024	600	1-1/2"	100'	94	\$549.99:
7059183	1185-3328	600	1-1/2"	250'	169	579.61:

All Parts: Hose not Included

Supreme Duty Hose Reels

T series Truck Mount

- Toughest hose reels in the spring driven line
- Extra large chassis is strongly supported by dual pedestal-style arms that span from the roller bracket down to the sturdy mounting base
- Perfect for off-road applications that demand reliability in the most abusive environments



Part No.	Vendor No.	Operating Pressure (PSI)	Hose I.D.	Hose Lgth. (ft)	Ship Wt. (lbs)	Price /ea
0401466	TSH-N-350	300	3/8"	50'	66	\$394.74:
0401467	TSH-N-3100	300	3/8"	100'	97	563.44:
7059136 **	TSHL-N-475	300	1/2"	75' Capacity	71	407.27:
7059061 **	TSHL-N-4100	300	1/2"	100' Capacity	80	433.94:
0401474	TMP-N-350	3000	3/8"	50'	72	547.53:
0401475	TMP-N-3100	3000	3/8"	100'	100	503.06:
7059053 **	TMPL-N-4100	3000	1/2"	100' Capacity	80	463.69:
7059120*†	TDMP-N-450	2500	1/2"	50'	77	885.32:

** Hose not Included

*† Dual Hydraulic Hose

SPECIAL PURPOSE AND SPRING DRAWN HOSE REELS

Hose Reels Cont.



High Capacity Spring Driven Hose Reels

- Built to handle large hose diameters
- Used in applications demanding large volume delivery in low and medium pressures such as fuel and water
- Sturdy box-style frame has heavy duty steel cross supports to all four corners for extra strength and rigidity



Part No.	Vendor No.	Operating Pressure (PSI)	Hose I.D.	Hose Lgth. (ft)	Ship Wt. (lbs)	Price
7059241	SLPL-650**	300	1"	**	109	\$597.05:
7059257	SLP-675	300	1"	75'	193	909.94:

** Hose not Included

Dual - Oxygen-Acetylene Hose Reels

- Ideal solution for managing bulky twin line welding hose
- Compact in size and shares the reputation for long lasting performance
- Has a large chassis and frame to accommodate longer lengths of welding hose



Part No.	Vendor No.	Operating Pressure (PSI)	Hose I.D.	Hose Lgth. (ft)	Ship Wt. (lbs)	Price
7059161	SHW-N-150	300	1/4"	50'	64	\$348.79:
7059123	SHW-N-1100	300	1/4"	100'	84	483.18:

Dual Purpose Hose Reels

- A combination of two hose reels in one compact assembly
- Perfect for applications where two sources are needed to get the job done when space is a critical factor
- Single mounting base creates stability and adds to the convenience of one mounting pattern



Part No.	Vendor No.	Operating Pressure (PSI)	Hose I.D.	Hose Lgth. (ft)	Ship Wt (lbs)	Price
7059015	C-LP-335-335	300	3/8"	2 x 35'	69	\$450.35:
7059016	C-LP-350-350	300	3/8"	2 x 50'	78	490.36:

Enclosed Hose Reels

- Protected by a powder coated steel casing that shields out the elements to protect and extend the life of the reel, the hose, and the components inside
- It adds a neat, tidy, aesthetic appearance to work environments that demand a clean and professional look
- The 3 piece casing is easy to assemble and disassemble for simple installation and maintenance



Part No.	Vendor No.	Operating Pressure (PSI)	Hose I.D.	Hose Lgth (ft)	Ship Wt (lbs)	Price
7059218	EN-N-350	300	3/8"	50'	65	\$350.84:

HOSETRACT HOSE REELS

Unitract Series

Reels are ideally suited for plant maintenance or many other industrial functions where hose storage is a problem. Standard hose for air, water and oxygen/acetylene applications. Hose can be dispensed and retracted with greater ease and expedience than coiling by hand. The Unitract series fits easily into height restricted areas.



- Weighs 10 lbs. less than our standard reels.
- Unitized multi-functional hub arbor requires fewer moving parts.
- 8 Position guide arm.
- Single set screw to access latch area and spring case.
- Minimal size envelope permits installation where space is a factor.
- Low pressure brass swivel reduces corrosion potential

Operating Pressure (PSI)	Hose I.D.	Part No.	Vendor No.	Hose Lgth. (ft)	Ship Wt. (lbs)	Price
300	3/8	0400213	UTL-325	25	40	\$163.78
300	3/8	0400217	UTL-350	50	41	227.12
300	1/2	0400220	UTL-550	50	45	240.27

C-Series



Available in Powder Coat or (304) Stainless

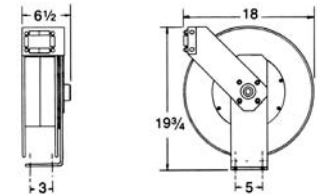

The C Series reels are a larger more durable product, applied where longer, higher volume hoses are required in all pressure ranges up to 8000 psi. Applications include: plant maintenance, off road or food process.

Operating Pressure (PSI)	Hose I.D.	Part No.	Vendor No.	Hose Lgth. (ft)	Ship Wt. (lbs)	Price /Reel
300	3/8	0439421	LC-350	50	54	\$298.79
300	3/8	0439422	LC-370	70	59	362.37
300	1/2	0439425	LC-550	50	60	356.45



General Industrial Spring Retractable Reels

- New hybrid, lighter, spring-driven hose reel with a composite spool designed for applications that are less demanding, yet require a product that can withstand industrial use.
- Easy to install and maintain, conveniently keeps hose organized for a more efficient, safer work area
- Series RT
- For use with Air and Water
- Hose included



Part No.	Vendor No.	Operating Pressure (PSI)	Hose I.D.	Hose Length	Ship Wt.	Price
7054332	RT435-OLP	300	1/4	35'	22	\$144.46:
7054333	RT450-OLP	300	1/4	50'	25	174.88:
7054334	RT635-OLP	300	3/8	25'	23	149.90:
7054336	RT650-OLP	300	3/8	50'	29	210.73:
7054339	RT850-OLP	300	1/2	50'	35	282.42:

HOSE REELS & INDUSTRIAL DUCTING

Hose Reels Cont.



Hose Reels

Premium Duty Spring Retractable Reels

- Durable and compact for a wide range of applications with critical space requirements
- A full flow shaft and swivel assures maximum product delivery
- Series 4000, 5000, 5005
- For use with Air and Water
- Hose included



Part No.	Vendor No.	Operating Pressure (PSI)	Hose I.D.	Hose Length	Ship Wt.	Price
7054403	5450 OLP	300	1/4	50'	26	\$248.74:
7054402	4625 OLP	300	3/8	25'	22	198.78:
7054354	5635 OLP	300	3/8	35'	25	236.79:
7054455	5650 OLP	300	3/8	50'	36	285.67:
7054355	A5825 OLP	300	1/2	25'	29	256.34:
7054362	A5850 OLP	300	1/2	50'	44	321.51:

Heavy Duty Industrial Spring Retractable Reels

- Series 7000, 80000
- Ideal for the most demanding applications
- Reel's base and guide arms are formed from high-grade steel and engineered with structural forms and gussets to yield the greatest amount of strength
- Hose included



Part No.	Vendor No.	Operating Pressure (PSI)	Hose I.D.	Hose Length	Ship Wt. (lbs)	Use With	Price
7054404	7650 OLP	300	3/8	50'	47	air/water	\$358.45:
7054405	7670 OLP	300	3/8	70'	50	air/water	379.90:
7054413	81100 OLP	300	3/8	100'	92	air/water	559.40:
7054406	7850 OLP	300	1/2	50'	51	air/water	371.49:
7054414	82100 OLP	300	1/2	100'	101	air/water	576.77:
7054384	83050 OLP	250	3/4	50'	88	air/water	553.97:
7054368	7650 OHP	4000	3/8	50'	60	grease	536.59:

Heavy Duty Hand Crank Reels

- Series 30000
- Hose not included
- Vibration-proof, self-locking fasteners to ensure assembly integrity
- Ideal for longer lengths of hoses



Part No.	Vendor No.	Operating Pressure (PSI)	Hose I.D.	Hose Capacity	Ship Wt. (lbs)	Price
7054434	CA32106 L	1000	1/2	100'	42	\$204.21:
7054442	CA33112 L	1000	3/4	100'	47	269.38:
7054444	CA33118 L	1000	3/4	175'	56	281.33:

Hose not included

Stainless Steel Reels

- Corrosion Resistant
- Ideal for food processing, pre-rinse, wash down, chemical transfer and industrial solvent handling
- Also suitable for coastal, offshore and on-board ship in marine applications where the harsh environment of salt water spray requires the use of stainless steel hose reels
- Hose and bumper stop not included



Part No.	Vendor No.	Operating Pressure (PSI)	Hose I.D.	Hose Length	Ship Wt. (lbs)	Air/Fluids	Price
7054486	5600 OLS	500	3/8	35'	23	series 5000	\$504.00:
7054469	7800 OLS	500	1/2	50'	44	series 7000	740.79:

Tool Balancers

- Makes tools nearly weightless, reducing operator fatigue
- Reduces operator fatigue
- Improves safety and ergonomics
- Increases productivity, keeps tool positioned for immediate use with minimal operator motion
- Reduces tool damage, prevent stools from being accidentally dropped



Part No.	Vendor No.	Load (lbs)	Description	Cable Length	Ship Wt. (lbs)	Price /Each
7050108	TB 03	1.5-3	Constant Tension	6'	1	\$52.14:
7054309	TB 05	3-5	Constant Tension	6'	1.2	52.14:
7054311	TBL 10	5-10	ratchet Lock	8'	10	242.23:
7054313	TBL 15	10-15	ratchet Lock	8'	10	291.11:
7054314	TBL 23	16-23	ratchet Lock	8'	10	319.34:

Industrial Ducting



CWGP (2 Ply Fabric Duct With Wire Support)

- Double-ply neoprene impregnated polyester fabric hose construction reinforced with a spring steel wire helix
- Excellent crush resistance and tensile strength
- Neoprene coating offers excellent abrasion and chemical resistance
- Handles positive and negative pressure
- Extremely flexible 25' duct
- Listed as UL 94 V-O flame retardant
- Temperature Range: -40°F to +250°F

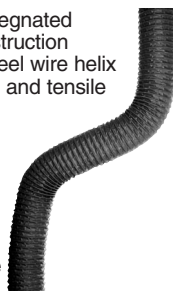

Size	Part No.	Price /Each
2"	0470325	\$157.80:
3"	0470326	178.75:
4"	0470327	202.77
5"	0470328	231.56:
6"	0470329	245.84
8"	0470330	314.20:
10"	0470331	390.14:
12"	0470332	472.71:

R-2 Blue & Clear (Plastic Ducting with Wire Support)

- Medium weight blue or clear PVC wall hose construction reinforced with a spring steel wire helix
- Good for positive pressure and light vacuum applications
- Combines extreme flexibility and excellent compressibility with tight bending characteristics
- Easy to clean, smooth inner surface assures minimal friction loss and efficient flow characteristics
- Resists weathering, chemicals, and moisture
- Good abrasion resistance
- Blue is listed as UL 94 V-O flame retardant
- Clear is manufactured FDA acceptable materials
- Temperature Range: +20°F to +160°F

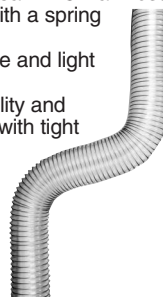

Blue Plastic Duct

Size	25'		50'	
	Part No.	Price /Each	Part No.	Price /Each
2"	0470191	\$81.86:	0470192	\$163.74:
3"	0470193	113.60:	0470194	227.32:
4"	0470195	133.25:	0470196	264.23:
6"	0470197	149.86:	0470198	299.93:
8"	0470199	207.57:	0470200	415.12:

Clear Plastic Duct

Size	25'		50'	
	Part No.	Price /Each	Part No.	Price /Each
2"	0470336	\$69.71	0470201	\$148.79:
3"	0470337	110.47:	0470202	228.57:
4"	0470338	129.73	0470203	266.66:
6"	0470339	147.44	0470204	306.31:
8"	0470340	206.24:	0470205	424.80:

Commercial (Crush Proof Polyethylene Vacuum Hose)

- Gray or black polyethylene copolymer wall hose construction reinforced with an integral polyethylene helix
- Two-part construction
- For industrial and commercial vacuum applications
- Crush-resistant
- Excellent flexing characteristics
- Superior abrasion resistance
- Smooth interior for efficient flow characteristics, minimum pressure drop, low friction loss, and clogging prevention
- All sizes handle full vacuum
- Size: 50 foot lengths
- Temperature Range: -40°F to +140°F

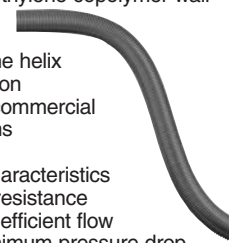

Size	Gray		Black	
	Part No.	Price /Each	Part No.	Price /Each
1-1/2"	0470352	\$94.35	0470354	\$98.80:
2"	0470353	162.42:	0470355	168.35

Industrial Ducting Cont.



MG-V (PVC Vacuum Hose)

- PVC wall hose construction reinforced with a vinyl coated spring steel wire helix
- Good chemical resistance
- Light weight & flexible
- Temperature rating: -10 to 160° F
- Standard Length: 50 ft.

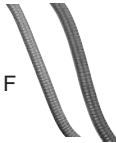

Size	Part No.	Price /ea
3/4"	0401524	\$72.60:
1"	0401525	77.27:
1 1/4"	0401526	102.33:
1 1/2"	0401527	116.48:
2"	0401528	162.37:

MG-U (Urethane Vacuum Hose)

- Elastomer urethane wall hose construction reinforced with a vinyl coated spring steel wire helix
- Light weight & flexible
- Good chemical resistance
- Temperature range: -60 to 160° F.
- Standard length: 50 ft.



Size	Part No.	Price /ea
3/4"	0401529	\$89.65:
1"	0401530	107.85:
1 1/4"	0401531	137.27:
1 1/2"	0401532	159.71:
2"	0401533	192.43:

T-7W (Thermoplastic General Purpose Ducting)

- Medium weight thermoplastic rubber wall hose construction with a yellow external wearstrip reinforced with a spring steel wire helix
- Designed for wide temperature ranges while maintaining flexibility
- Good abrasion resistance
- Suited for extreme moisture and broad chemical applications
- Resistant to ozone, UV rays, weathering and chemicals
- Highly visible yellow wearstrip offers external abrasion resistance
- Combines extreme flexibility and excellent compressibility with tight bending characteristics
- Easy to clean, smooth inner surface assures minimal friction loss and efficient flow characteristics
- Temperature Range: -40°F to +275°F



Size	25'		50'	
	Part No.	Price /Each	Part No.	Price /Each
3"	0470341	\$120.50	0470254	\$253.70:
4"	0470342	155.88	0470255	325.36:
5"	0470343	165.23	0470256	345.77:
6"	0470344	181.48	0470257	378.14:
8"	0470345	235.45	0470258	492.03:
10"	0470346	306.78:	0470259	635.80:
12"	0470347	366.72:		
14"	0470348	525.35:		
16"	0470349	596.70:		

FSP-5 (Ventilation Ducting for Blowing Applications)

- Single-ply yellow polyester reinforced PVC vinyl fabric hose construction with an external wearstrip reinforced with a spring steel wire helix.
- Lightweight 25' duct for blower applications.
- Highly compressible.
- Retractability allows for convenient storage and easy transport in a fraction of its fully extended length.
- Low friction loss.
- Wearstrip offers external abrasion resistance.
- Listed as UL 94 V-O flame retardant.
- Temperature Range: -20°F to +180°F



Size	Part No.	Price /Each
8"	0470333	\$185.59
10"	0470334	503.28:
12"	0470335	442.25:

Fix-Thane® LD (Abrasion Resistant Polyurethane Ducting)

- Light weight black or clear polyurethane wall hose construction reinforced with a bronze coated spring steel wire helix
- Excellent compressibility
- Cut, gouge, and chemical resistant
- Offers maximum combination of flexibility and abrasion resistance
- Temperature range: -65 to 225 ° F
- Standard Length of 25 ft.



Size	Part No.	Clear	
		Price /ea	
2"	0401495	\$89.99:	
3"	0401496	136.13:	
4"	0401497	173.73:	
5"	0401498	208.73:	
6"	0401499	243.18:	
8"	0401500	296.44:	
10"	0401501	402.35:	
12"	0401502	481.81:	

Fix-Thane® MD (Abrasion Resistant Polyurethane Ducting)

- Medium weight black or clear polyurethane wall hose construction reinforced with a bronze coated spring steel wire helix.
- Excellent compressibility.
- Offers maximum combination of flexibility and abrasion resistance.
- Cut, gouge and chemical resistant.
- Efficient flow characteristics.
- Designed for wide temperature ranges.
- Temperature Range: -65°F to +225°F



Black Polyurethane Duct

Size	25'		50'	
	Part No.	Price /Each	Part No.	Price /Each
3"	0470206	\$223.10:	0470207	\$445.98:
4"	0470208	282.76:	0470209	565.39:
6"	0470212	334.69:	0470213	669.28:
8"	0470214	423.14:	0470215	844.42:
10"	0470216	586.48:		

Clear Polyurethane Duct

Size	25'		50'	
	Part No.	Price /Each	Part No.	Price /Each
3"	0470222	\$223.10:	0470223	\$445.98:
4"	0470224	282.76:	0470225	565.39:
5"	0470226	323.57:	0470227	646.81:
6"	0470228	334.69:	0470229	669.28:
8"	0470230	423.14:	0470231	844.42:
10"	0470232	586.48:		
12"	0470233	649.44:		

Tiger Tail (Crush Proof Polyethylene Vacuum Hose)

- Rugged yellow polyethylene wall hose construction reinforced with an integral polyethylene helix
- Intended for liquid suction applications and ideally suited for the removal of fluids and waste materials
- 50' hose handles a full vacuum.
- Extremely flexible, even in sub-zero temperatures
- Smooth interior for efficient flow characteristics, minimum pressure drop, low friction loss, and clogging prevention
- Sleek exterior reduces drag for easy maneuverability
- Superior abrasion and crush resistance
- Resistant to kinking
- Made with factory-installed polyweld cuffs
- Temperature Range: -40°F to +140°F



Size	Part No.	Price /Each
2"	0470238	\$306.83:
3"	0470239	450.47:
4"	0470240	770.92:

GS (2 Ply Silicone Coated Fiberglass Fabric Duct)

- Double-ply silicone coated woven fiberglass fabric hose construction with an external filament fiberglass cord reinforced with a spring steel wire helix
- Designed for both high and low temperature extremes
- Suited for air handling applications at low positive and low negative pressures
- Narrow pitch allows for tight bending radius while maintaining a smooth air flow
- Extremely lightweight and flexible
- Non-kinking
- Resistant to many oils/solvents, ozone, water, fungus, and alkalis
- Not recommended for continuous flexing
- 12' fabric duct
- Temperature Range: -65°F to +550°F

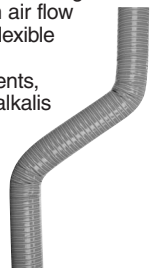

Size	Part No.	Price /Each
1"	0470241	\$110.52:
1-1/2"	0470242	129.53:
2"	0470243	136.93:
2-1/2"	0470244	167.17:
3"	0470245	175.32:
4"	0470246	208.21:
5"	0470247	247.44:
6"	0470248	284.29:

IND. DUCTING & PNEUMATIC QUICK DISCONNECTS

Industrial Hose Accessories

Industrial Ducting Cont.



Flarelock (Crush Proof Rubber Hose)

- Lightweight rubber wall hose construction.
- Ideal for carbon monoxide exhaust applications
- Resistant to heat, aging, gasoline, oil, and fumes
- No wire or metal; even when flattened 100%, the hose immediately returns to its original shape
- Hose adapters and accessories available
- 10' rubber hose
- Temperature Ranges:
2": +375°F
2-1/2": +375°F
3"-5": +375°F



Size	Part No.	Price /Each
2"	0470249	\$59.14:
2-1/2"	0470250	67.08:
3"	0470251	77.33:
4"	0470252	117.00:

Sump Pump Hose Kits

- Material: UV & crack resistant plastic
- Ends: Molded for easy clamping
- Length: 24 ft.

Sump Pump Hose Kits

Kit contains clamp and pipe adapter.



Size	Part No.	Price /ea
1 1/4"	0401534	\$9.99:
1 1/2"	0401535	12.65:

Pneumatic Quick Disconnects Cont.



Pneumatic Quick Disconnects

- Swing Couplings by Oetiker offer unrestricted full flow with safe, quick connection and disconnection under pressure
- Pneumatic Quick Disconnect Safety Coupler with Full Flow.
- No pressure at Disconnection



Part No.	Series	Product	Price
1/4" Industrial Series:			
0400426	B1	1/4" NPT Female Swing Coupling	\$23.38
0400428	B1	1/4" NPT Male Swing Coupling	22.00
Plugs (1/4"):			
0400442	B1	1/4" NPT Male Coupling Plug	2.63
0400443	B1	1/4" NPT Female Coupling Plug	2.90
3/8" Industrial Series:			
0400433	E	3/8" NPT Female Swing Coupling	24.08
0400435	E	3/8" NPT Male Swing Coupling	22.70
0400436	E	1/2" NPT Male Swing Coupling	22.70
0400434	E	1/2" NPT Female Swing Coupling	24.08
Plugs (3/8"):			
0400449	E	3/8" NPT Male Coupling Plug	3.30
0400451	E	3/8" NPT Female Coupling Plug	3.58
0400450	E	1/2" NPT Male Coupling Plug	3.58
Coupling Covers			
0400454		1/4" Black Swing Coupling Cover for A1 and B1 Series	3.45
0400455		1/4" Orange Swing Coupling Cover for A1 and B1 Series	1.38
0400456		3/8" Black Swing Coupling Cover for D and E Series	3.45
0400457		3/8" Orange Swing Coupling Cover for D and E Series	1.38

1/4" MULTI-SOCKET Universal Quick Disconnect



- Universal coupler that ends "coupler confusion"
- Compatible with Industrial, ARO, or Tru-flate styles
- Durable nickel plated brass exterior and stainless steel locking balls and springs



Part No.	Vendor No.	Hose End	Price
0421900	80191-04	1/4 Male NPT	\$7.38
0421901	80191-06	3/8 Male NPT	7.38
0421902	80191-08	1/2 Male NPT	7.95
0421903	80192-04	1/4 Female NPT	7.80
0421904	80192-06	3/8 Female NPT	7.80
0421905	80192-08	1/2 Female NPT	8.45
0421906	80193-04	1/4 Hose Barb	7.80
0421907	80193-06	3/8 Hose Barb	7.80
0421908	80193-08	1/2 Hose Barb	8.45

Pneumatic Quick Disconnects



Female NPT Straight Body Industrial Interchange Profile



Specifications for C9000 Safety Couplers

- Fluids: Compressed Air
- Body Material: Nylon 6.6
- Seal: Nitrile
- Pressure Rating: up to 230 PSI
- Temperature Range: -4°F to +140°F
- Thread Sizes: 1/4" to 1/2"
- Thread Types: NPT

Industrial Applications: C9000 is used for any application (assembly, construction, air craft industry, automotive) where safety, durability, and performance are demanded.

Body	Thread	Part No.	Vendor No.	Price /Each
1/4"	1/4" NPT	0443215	9415U06 14	\$20.94
1/4"	3/8" NPT	0443216	9415U06 18	20.94
3/8"	3/8 NPT	0443221	9415U08 18	25.29
3/8"	1/2 NPT	0443222	9415U08 22	25.29

Male NPT Straight Body Industrial Interchange Profile



Barbed Connector Body Industrial Interchange Profile



Body	Thread	Part No.	Vendor No.	Price /Each
1/4"	1/4" NPT	0443213	9405U06 14	\$20.94
1/4"	3/8 NPT	0443214	9405U06 18	20.93
3/8"	3/8 NPT	0443219	9405U08 18	25.29
3/8"	1/2 NPT	0443220	9405U08 22	25.29

Body	Hose I.D.	Part No.	Vendor No.	Price /Each
1/4"	1/4	0443217	9421U06 06	\$20.94
1/4"	3/8	0443218	9421U06 10	20.93
3/8"	3/8	0443223	9421U08 10	25.29
3/8"	1/2	0443224	9421U08 13	31.31

FITTINGS SIMPLIFIED

SWIFT-FIT MULTI-SOCKET

PUSH-IN FITTINGS COMPATIBLE WITH INCH & METRIC THREAD TYPES
 UNIVERSAL QUICK COUPLER COMPATIBLE WITH MULTIPLE PLUG TYPES

PNEUMATIC QUICK DISCONNECTS

Pneumatic Quick Disconnects Cont.

Identification Chart Actual Size

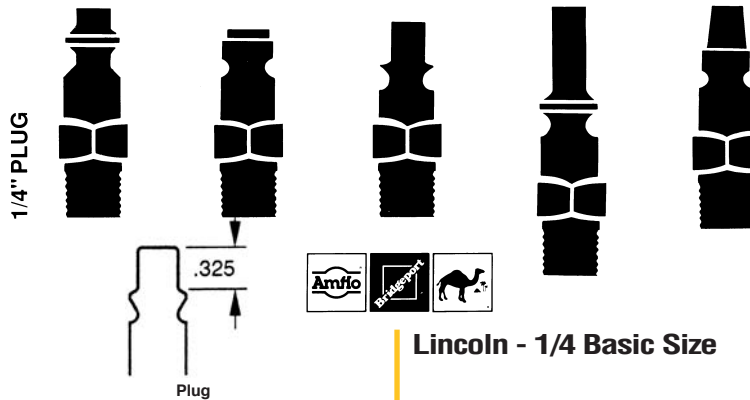
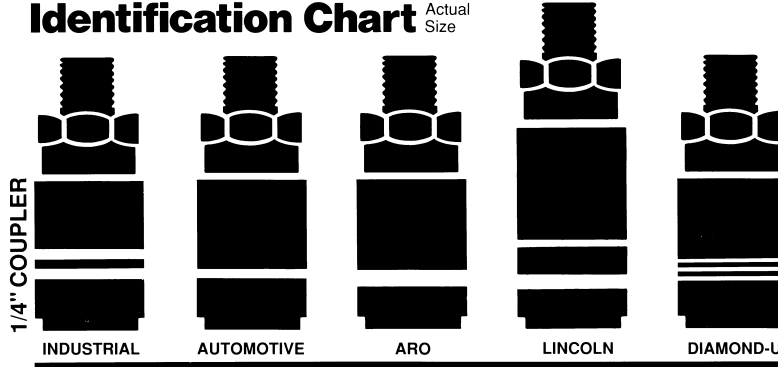

Amflo

Aro - 1/4 Basic Size

Female Thread

Size	Plug		Manual Coupler		Automatic Coupler		Safety Latch	
	Part No.	Price /Each	Part No.	Price /Each	Part No.	Price /Each	Part No.	Price /Each
1/8 NPT	430000	\$1.61			430200	\$6.74		
1/4 NPT	430001	1.19	430101	5.10	430201	4.98	430301	8.29
3/8 NPT	430002	3.63	430102	6.76	430202	6.44	430302	7.77

Male Thread

Size	Plug		Manual Coupler		Automatic Coupler	
	Part No.	Price /Each	Part No.	Price /Each	Part No.	Price /Each
1/8 NPT	430003	\$1.74	430103	\$1.42	430203	\$6.68
1/4 NPT	430004	1.03	430104	5.31	430204	6.43
3/8 NPT	430005	2.66	430105	7.55	430205	6.95

Hose Stem

Size	Plug		Manual Coupler		Automatic Coupler		Barb-Tite Plug	
	Part No.	Price /Each	Part No.	Price /Each	Part No.	Price /Each	Part No.	Price /Each
1/4 I.D.	430006	\$2.68	430106	\$6.81	430206	\$7.71	430406	\$2.31
5/16 I.D.	430007	3.75			430207	6.73		
3/8 I.D.	430008	2.70	430108	7.13	430208	7.77	430408	2.90

Aro - 3/8 Basic Size



Female Thread

Size	Plug		Manual Coupler	
	Part No.	Price /Each	Part No.	Price /Each
3/8 NPT	430010	\$3.60	430110	\$12.06

Male Thread

Size	Plug		Manual Coupler	
	Part No.	Price /Each	Part No.	Price /Each
3/8 NPT	430013	\$3.60	430113	\$13.93

Lincoln - 1/4 Basic Size

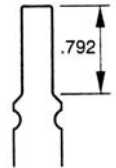

1/4 Female Thread

Size	Plug		Manual Coupler		Automatic Coupler	
	Part No.	Price /Each	Part No.	Price /Each	Part No.	Price /Each
1/4 NPT	430014	\$1.81	430114	\$7.13	430214	\$9.13

1/4 Male Thread

Size	Plug		Manual Coupler		Automatic Coupler	
	Part No.	Price /Each	Part No.	Price /Each	Part No.	Price /Each
1/4 NPT	430015	\$1.73	430115	\$8.31	430215	\$8.50

Industrial - 1/4 Basic Size

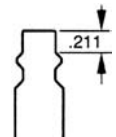

Female Thread

Size	Plug		Manual Coupler		Automatic Coupler	
	Part No.	Price /Each	Part No.	Price /Each	Part No.	Price /Each
1/8 NPT	430016	\$1.52	430116	\$9.21	430216	\$7.58
1/4" NPT	430017	0.95	430117	4.05	430217	6.11
3/8 NPT	430018	1.99	430118	5.38	430218	7.94

Male Thread

Size	Plug		Manual Coupler		Automatic Coupler	
	Part No.	Price /Each	Part No.	Price /Each	Part No.	Price /Each
1/8 NPT	430019	\$1.40	430119	\$7.68	430219	\$6.76
1/4" NPT	430020	0.90	430120	4.25	430220	6.28
3/8 NPT	430021	1.98	430121	4.72	430221	7.60

Hose Stem

Size	Plug		Manual Coupler		Automatic Coupler		Barb-Tite Plug		Barb-Tite Coupler	
	Part No.	Price /Each	Part No.	Price /Each	Part No.	Price /Each	Part No.	Price /Each	Part No.	Price /Each
1/4" I.D.	430022	\$2.14	430122	\$5.20	430222	\$7.94	430422	\$2.95	430522	\$6.76
5/16 I.D.	430023	2.62			430223	8.22				
3/8" I.D.	430024	2.08	430124	6.14	430224	7.94	430424	2.34	430524	6.50

The : symbol after a price denotes that it is a Direct Ship Product (DSP) and shipping, availability & lead times may vary.

HYDRAULICS, PNEUMATICS & POWER TRANSMISSION

PNEUMATIC QUICK DISCONNECTS

Pneumatic Quick Disconnects Cont.

Amflo.

Industrial Hose Accessories

Industrial - 3/8 Basic Size

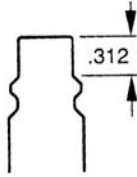

Female Thread

Size	Plug		Manual Coupler		Automatic Coupler	
	Part No.	Price /Each	Part No.	Price /Each	Part No.	Price /Each
1/4 NPT	430025	\$2.74	430125	\$9.76	430225	\$11.77
3/8 NPT	430026	2.18	430126	8.84	430226	14.70
1/2 NPT	430027	2.78	430127	12.59	430227	15.72

Male Thread

Size	Plug		Manual Coupler		Automatic Coupler	
	Part No.	Price /Each	Part No.	Price /Each	Part No.	Price /Each
1/4 NPT	430028	\$2.10	430128	\$11.33	430228	\$14.41
3/8 NPT	430029	1.98	430129	9.17	430229	14.56
1/2 NPT	430030	4.49	430130	13.93		

Hose Stem

Size	Plug		Manual Coupler		Barb-Tite Plug		Barb-Tite Coupler	
	Part No.	Price /Each	Part No.	Price /Each	Part No.	Price /Each	Part No.	Price /Each
1/4 hose I.D.	430031	\$4.19			430431	\$4.77	430531	\$13.66
3/8 hose I.D.	430032	3.38	430132	9.91	430432	13.50	430532	12.32
1/2 Hose I.D.	430033	3.97	430133	12.32				

Industrial - 1/2 Basic Size

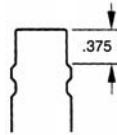

Female Thread

Size	Plug		Manual Coupler	
	Part No.	Price /Each	Part No.	Price /Each
3/8 NPT	430034	\$3.72	430134	\$14.46
1/2 NPT	430035	3.22	430135	13.46

Male Thread

Size	Plug		Manual Coupler	
	Part No.	Price /Each	Part No.	Price /Each
3/8 NPT	430038	\$3.33	430138	\$12.32
1/2 NPT	430039	3.17	430139	11.91

Hose Stem

Size	Plug		Manual Coupler	
	Part No.	Price /Each	Part No.	Price /Each
3/8 Hose I.D.	430041	\$3.78		
1/2 Hose I.D.			430142	13.39

Bulk Air hose is available on page 10-121.

Find a wide selection of hose clamps on page 10-138.

Tru-Flate - 1/4 Basic Size

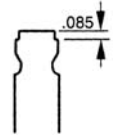

Female Thread

Size	Plug		Manual Coupler	
	Part No.	Price /Each	Part No.	Price /Each
1/4 NPT	430045	\$0.86	430145	\$4.24
3/8 NPT	430046	2.10	430146	5.90

Male Thread

Size	Plug		Manual Coupler	
	Part No.	Price /Each	Part No.	Price /Each
1/4 NPT	430048	\$0.88	430148	\$4.29
3/8 NPT	430049	2.36	430149	5.74

Hose Stem

Size	Plug		Manual Coupler		Barb-Tite Plug		Barb-Tite Coupler	
	Part No.	Price /Each	Part No.	Price /Each	Part No.	Price /Each	Part No.	Price /Each
1/4 I.D.	430050	\$2.60	430150	\$6.23	430450	\$1.83	430550	\$6.43
3/8 I.D.	430052	2.33	430152	6.70	430452	2.42	430552	6.70

Tru-Flate - 3/8 Basic Size

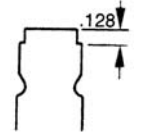

Female Thread

Size	Plug		Manual Coupler	
	Part No.	Price /Each	Part No.	Price /Each
1/4 NPT	430053	\$1.94	430153	\$8.84
3/8 NPT	430054	1.99	430154	7.40
1/2 NPT	430055	3.67	430155	13.47

Male Thread

Size	Plug		Manual Coupler	
	Part No.	Price /Each	Part No.	Price /Each
1/4 NPT	430056	\$1.94	430156	\$7.35
3/8 NPT	430057	1.99	430157	6.98
1/2 NPT	430058	3.67	430158	12.59

Hose Stem

Size	Plug		Manual Coupler		Barb-Tite Plug		Barb-Tite Coupler	
	Part No.	Price /Each	Part No.	Price /Each	Part No.	Price /Each	Part No.	Price /Each
1/4 Hose I.D.	430059	\$3.35	430159	\$10.98	430459	\$3.33	430559	\$13.39
3/8 Hose I.D.	430060	2.73	430160	10.98	430460	3.33	430560	9.65
1/2 Hose I.D.			430161	12.32				

Tru-Flate - 1/2 Basic Size

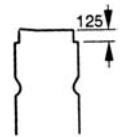

Female Thread

Size	Plug		Manual Coupler	
	Part No.	Price /Each	Part No.	Price /Each
3/8 NPT	430062	\$2.88	430162	\$12.59
1/2 NPT	430063	3.91	430163	10.61

Male Thread

Size	Plug		Manual Coupler	
	Part No.	Price /Each	Part No.	Price /Each
3/8 NPT	430066	\$3.49	430166	\$12.59
1/2 NPT	430067	3.17	430139	11.91

Hose Stem

Size	Plug		Manual Coupler	
	Part No.	Price /Each	Part No.	Price /Each
1/2 Hose I.D.	430070	\$4.88	430170	\$13.39

SHO AND TIRE ACCESSORIES & PNEUMATIC QUICK DISCONNECTS

Pneumatic Quick Disconnects Cont.

Amflo

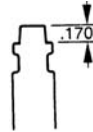

Universal - 1/4 Basic Size

1/4 Female NPSM	
Part No.	Price /Each
430272	\$8.15

1/4 Male	
Part No.	Price /Each
430273	\$9.77

1/4 Hi-Flo™ Couplers and Plugs For Maximum Flow



1/4 Female NPT					
Plug	Price /Each	Brass Coupler	Price /Each	Steel Coupler	Price /Each
Part No.		Part No.		Part No.	
0430565	\$1.08	0430562	\$5.90	0430564	\$6.74

1/4 Male NPT			
Plug	Price /Each	Brass Coupler	Price /Each
Part No.		Part No.	
0430566	\$1.16	0430563	\$6.58



Professional Tire Pressure Gauges

- Easy to Read
- Portable
- ANSI Grade B Accuracy
- Shock Resistant with Release Button



Part No.	Vendor No.	Pressure	Price
0267366	AG010039	160 lbs/in	\$14.68
0267367	AG010041	200 lbs/in	21.10

Handy Tire Pressure Gauge

- 2 in Dial
- Pressure Range 0-60 PSI
- Angled Stem
- Release button on chuck



Part No.	Vendor No.	Pressure	Price
0267835	AG10042	0-60 psi	\$10.12

Professional Tire Pressure Gauge

- Easy to Read
- 2" dial
- Release button on chuck



Part No.	Vendor No.	Pressure	Price
0267836	AG10042A	0-60 psi	\$10.86

Amflo

Accessories



OSHA Style Blow Gun

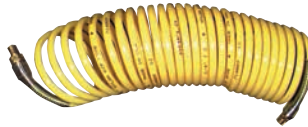

Recoil Hose Assembly



Rubber Tipped Blow Gun

Part No.	Vendor No.	Description	Price /Each
0400225	905D	10 to 50psi Pencil Type Pocket Pressure Gauge	6.14
0430567	903D	10-150 PSI Tire Gauge	26.78
0430568	908D	20 to 120psi, Pocket Pressure Gauge with Dual Foot Chuck	8.42
0430570	180	12-120PSI Inflator Gauge, Sight Glass, 12" Hose	42.27
430082	104	1/4" NPT Female- Ball Foot Chuck	\$3.49
0400223	104ZN	1/4" NPT Female Zinc Ball Foot Chuck for Live Air Lines	2.62
0430569	101	Air Inflator with Gauge	50.62
430085	0659 00 14	Standard Polymer Blowgun	21.44
430083	204-30	OSHA Style Blow Gun	10.25
430096	201	rubber tipped blow gun	14.82
0430571	202	Rubber Replacement Tip for 201 blow gun	3.66
430086	4-25	Recoil Hose Assembly 1/4"- 25' Nylon 11	16.80
430087	4-50	Recoil Hose Assembly 1/4"- 50' Nylon 11	29.41
430084	3404	3-1 Manifold, 1/4 in, 1/4 ports	10.40
430085	3406	3-1 Manifold, 3/8 in, 1/4 ports	10.79
0430573	700	1/8 NPT Tank Valve w/Schroeder valve	1.94

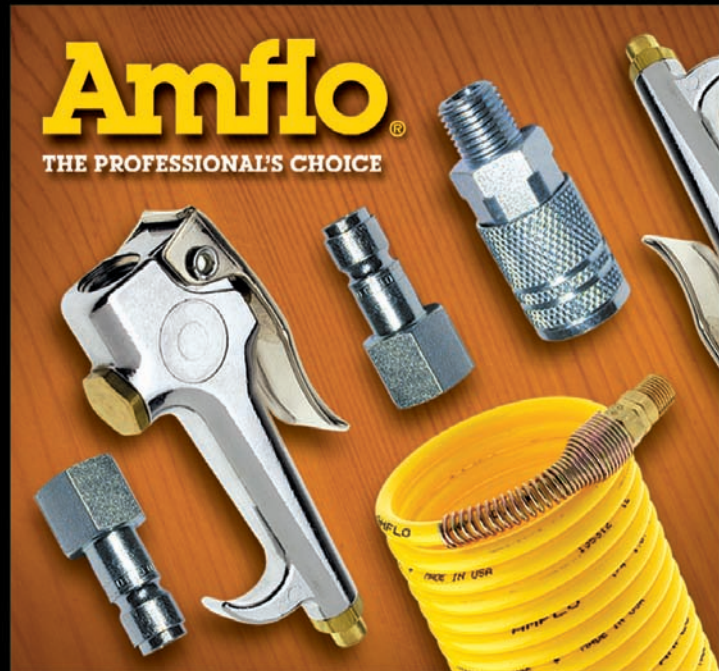

Amflo offers a full line of air-line accessories for the professional, featuring a wide variety of Blowguns, Couplers, Plugs and Air Hoses. Available in a range of popular sizes and designs, Amflo air-line products have got you covered.

PLEWS & EDELMANN

A Tomkins Company

©2006

SAFETY AIR GUNS

Pneumatic Quick Disconnects Cont. Replacement Nozzles



Long John® Safety Air Guns

- Venturi nozzle delivers high power for industrial cleaning applications
- Delivers 100% more thrust than conventional air guns
- Extensions allow access to hard to reach areas
- Ergonomic pistol grip and trigger reduce hand fatigue
- Durable cast aluminum body features a built-in hanger for easy storage
- Meets OSHA standards

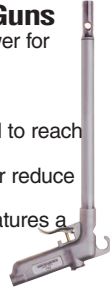

Part No.	Vendor No.	Extension Lgth.	Price /Ea
0423800	75LJ012AA	12"	\$28.60
0423801	75LJ018AA	18"	29.81
0423802	75LJ024AA	24"	31.25
0423803	75LJ036AA	36"	33.22
0423804	75LJ048AA	48"	35.53
0423805	75LJ060AA	60"	37.84
0423806	75LJ072AA	72"	40.26

Part No.	Vendor No.	Description	Use With	Price /Ea
0423807	75LJNA-1	Alumn. Nozzle	75LJ & U75LJ	\$4.73
0423808	75LJNS	Steel Nozzle	75LJ & U75LJ	11.99



BLO-Hard® Safety Air Gun

- Lightest Extended Reach Airgun
- Constructed of rugged die cast aluminum
- The perfect tool for cleaning hard to reach areas
- Meets OSHA standards



Part No.	Vendor No.	Extension Lgth.	Price /Ea
0423825	900	--	\$12.65
0423826	900LJ012AA	12"	24.64
0423827	900LJ024AA	24"	25.74

Xtra Thrust Safety Air Gun

- Most Powerful Safety Airgun
- Delivers 250% more thrust than conventional air guns
- Venturi nozzle delivers maximum power for industrial cleaning applications
- Extensions allow access to hard to reach areas
- Meets OSHA Standards

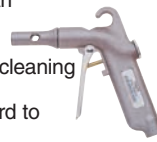

Part No.	Vendor No.	Extension Lgth.	Price /Ea
0423815	75XXT	--	\$26.29
0423816	75XT012AA	12"	33.00
0423817	75XT024AA	24"	35.31
0423818	75XT036AA	36"	37.62
0423819	75XT048AA	48"	39.93

Cross-Reference for Quick Disconnect Fittings

Fastenal	Tomco	Amflo	Aro	Camel	Collhouse	Foster	Hansen	NAPA	Milton	Parker	Schrader	Tru-Flate	Lincoln	Dixon
Industrial Interchange-Manual Sleeve Type Couplings														
430120	A181	C21	23102-212	61-578	152	3103	1100	90-672	716	B22	5139/5141-12	13-224/225	0	DCB21
430121	A182	C21-03	23102-213	61-535	155	3303	1300	90-657	719	B22E	51140-12	13-226	0	DCB2103
430117	A184	C20	23102-200	61-573	150	3003	1000	90-670	715	B23	5138/5142-12	13-235/236	632004	DCB20
430118	A185	C20-23	23102-3	0	151	3203	1200	90-667	718	B23E	5263-12	13-236	0	DCB2023
430122	A186	C20-42	23102-22	61-575	153	3603	1600	90-671	717	B20-3B	B203B	13-264	0	DCB2042
430124	A187	C20-44	23102-24	0	156	3703	1700	0	717-6	B20-5B	B205B	0	0	DCB2044
430125	PT400	C26-22	23103-300	0	582	4004	400	90-629	1833	25C	25C	0	0	DC8
430126	PT420	C26	MSCF33-000	61-482	580	4204	420	90-680	1835	25	3541	15-536/537	642006	DC6
430129	PT430	C25	23103-313	61-483	581	4304	430	90-682	1836	24	24	13-526/527	0	DC5
430132	PT480	C26-44	MSCH33-000	0	586	4804	4006	90-635	1836-6	24-6B	245B	0	0	DC644
430135	T250	C10	23104-400	61-563	120	5205	520	90-662	1815	17	3512	13-712/713	0	DC10
430139	T530	C9	23104-14	61-564	122	5305	530	90-664	1816	16	3511	13-704	0	DC9
Industrial-Interchange Plugs														
430028	T40	CP25-02	23903-210	0	5803	40-4	40	90-605	1839	HOE	HOE	0	64104	DCP25
430029	T42	CP25	23903-310	61-484	5801	42-4	42	90-683	1837	H2E	3542	12-526/527	64106	DCP25
430026	T43	CP26	23903-300	61-485	5802	43-4	43	90-681	1838	H3E	3548	12-536/537	54026	DCP26
430032	T48	CP25-44	23903-420	0	5806	48-4	406	90-651	1837-6	H5E	HO5E	0	0	DCP2544
430033	T49	CP25-45	23904-426	0	5808	49-4	408	0	0	H6E	HO6E	0	0	DCP2545
430038	T52	CP17-03	23904-310	61-133	1203	52-5	52	90-575	1859	HOF	HOF	0	0	DCP1703
430039	T54	CP17	23904-410	62-134	1201	54-5	54	90-578	1857	H2F	H2F	12-752	650108	DCP17
430035	T55	CP18	23904-400	61-137	1202	55-5	55	90-588	1858	H3F	H3F	12-672	650208	DCP18
430042	T60	CP17-45	23904-520	0	1208	60-5	50	0	0	H5F	H5F	0	0	DCP1745
430020	1804	CP21	23902-210	61-578	1501	.103	10	90-674	727	H2C	H2C	12-224/225	630104	DCP21
430017	1805	CP20	23902-200	61-579	1502	.11-3	11	90-676	728	H3C	5139-11	12-234/235	630204	DCP20
430021	1806	CP21-03	23902-3	61-535	1503	14-3	12	90-677	733	H2C-E	5263-11	12-226	0	DCP2103
430024	1826	CP21-44	23902-420	0	1508	17-3	17	0	736-6	H9C	H9C	12-266	0	DCP2144
ARO 210 Type Couplers/Plugs														
430101	100	C38	210	61-526	140	210-3003	20AS25F	90-644	775	B53	3526	13-334/335	862	DC38
430104	101	C37	210-212	61-527	142	210-3103	20AS25M	90-695	776	B52	3525	13-324/325	0	DC37
430106	104	C38-42	210-022	0	1406	210-16	20AS25H	0	776-4	A8C	A8C	0	0	DC3842
430004	200	CP37	2608	61-528	1401	210-10	20AP25M	90-618	777	A2C	3529	12-324/325	13329	DCP37
430001	300	CP38	2609	61-529	1402	210-11	20AP25F	90-620	778	A3C	3530	12-334/335	13331	P38
430006	400	CP37-42	3946	0	1406	210-16	20AP25H	0	777-4	A8C	0	0	0	DCP3742
Truflate Sleeve Type Couplers														
430057	PT42	CP5	TFPM33	61-558	5901	TF42	31AP25M	90-658	1807	2E	3517	12-604/605	5875	DCP5
430054	PT43	CP6	TFPF33	61-559	5902	TF41	31AP25F	90-660	1808	1E	3518	12-612	5876	DCP6
430154	PT420	C6	TFCF33	61-553	590	TF4204	31ASA37F	90-654	1805	B15	3516	13-612	5874	DC6
430157	PT430	C5	TFCM33	61-554	591	TF4304	31AS37M	90-656	1806	B14	3515	13-604	0	DC5
430048	2154	CP1	TFPM22	61-538	1601	TF10	21AP25M	90-624	783	2C	3506	12-124/125	5872	DCP1
430045	2155	CP2	TFPF22	61-539	1602	TF11	21AP37M	90-626	784	3C	3507	12-134/135	5873	DCP2
430148	A2181	C1	TFCN22	61-254	162	TF3103	21AS25M	90-610	786	B12	3503	13-124/125	5870	DC1
430145	A2184	C2	TFCF22	61-523	160	TF3003	21AS25F	90-600	785	B13	3504	13-134/135	5871	DC2
430150	A2186	C2-42	TFCH22-000	0	163	TF3603	21AS25H	90-607	786-4	B103B	0	13-164	0	DC242
430152	A2188	C2-44	TFCH23-000	0	166	TF3703	21AS37H	90-611	786-6	B105B	0	0	0	DC244
Lincoln Type Couplers and Plugs														
430114	1100	C28	LNCF22	61-548	170	LN3003	0	90-644	790	B73	3528	13-434/435	815	DC28
430115	1101	C27	LNM20	61-486	172	LN3103	0	90-645	794	B72	3527	13-424/425	0	DC27
430015	1109	CP27	LNPM22	61-550	1701	LN310	0	90-648	791	L2C	3531	12-424/425	11659	DCP27
430014	1110	CP28	LNPF22	61-551	1702	LN11	0	90-650	792	L3C	3532	12-434/435	11661	DCP28

The above interchange chart is a cross reference of the most popular part numbers in current use.

HYDRAULIC (DOUBLE SHUT-OFF) QUICK COUPLERS

Hydraulic (Double Shut-Off) Quick Couplers

TUTHILL Coupling Group | Hansen Couplings
Coupleurs Gromelle

Hydraulic (Double Shut-Off) Quick Couplers - HK Series

HK quick-couplers have fast-acting poppet valves in both the plug and coupler to effectively prevent fluid loss on disconnect. Industry terminology for the HK series is "hydraulic couplings." However, they also have wide application on vacuum systems, steam liquid, gases and other installations where fluid loss during connection or disconnection is undesirable.

Industrial Interchange ISO "B"
Interchanges with: Parker 60 Series or Tomco THK

Temperature: -40°F to +225°F
Standard Seals: Nitrile



HK Series Plug

Steel	Part No.	Vendor No.	Price /Each
1/8"	0482600	1K11	\$4.89
1/4"	0482601	2K16	6.26
3/8"	0482602	3K21	9.07
1/2"	0482603	4KP26	11.47
3/4" *	0482604	6KP31	16.52
1"	0482605	8KP36	21.81
Brass			
1/8"	0482612	B1K11	5.10
1/4"	0482613	B2K16	6.89
3/8"	0482614	B3K21	9.14
1/2"	0482615	B4KP26	13.64
3/4" *	0482616	B6KP31	46.90
1"	0482617	B8KP36	26.82
Stainless Steel (303)			
1/8"	0482624	B1K11	14.63
1/4"	0482625	LL2K16	14.80
3/8"	0482626	LL3K21	24.93
1/2"	0482627	LL4KP26	34.77
3/4" *	0482628	LL6KP31	60.40
1"	0482629	LL8KP36	95.69

HK Series Manual Coupler

Steel	Part No.	Vendor No.	Price /Each
1/8"	0482606	1H11	\$12.97
1/4"	0482607	2H16	12.88
3/8"	0482608	3H21	19.36
1/2"	0482609	4HP26	25.14
3/4" *	0482610	6HP31	38.37
1"	0482611	8HP36	50.45
Brass			
1/8"	0482618	B1H11	11.28
1/4"	0482619	B2H16	14.27
3/8"	0482620	B3H21	20.25
1/2"	0482621	B4HP26	31.46
3/4" *	0482622	B6HP31	54.98
1"	0482623	B8HP36	72.98
Stainless Steel (303)			
1/8"	0482630	LL1H11	37.96
1/4" *	0482631	LL2H16	38.50
3/8" *	0482632	LL3H21	49.72
1/2" *	0482633	LL4HP26	92.88
3/4" *	0482634	LL6HP31	148.29
1"	0482635	LL8HP36	229.05

*Available with British parallel pipe thread by special order.

Vinyl Dust Cap

Dust caps and plugs prevent contamination of disconnected fluid systems. They prevent the introduction of dirt, grit, and other contaminants into system through the Series HK component.



Size	Part No.	Dust Cap	Price /Each
1/8"	0482636	PPDC1HK	\$5.36
1/4"	0482637	PPDC2HK	4.68
3/8"	0482638	PPDC3HK	6.19
1/2"	0482639	PPDC4HK	7.71
3/4"	0482640	PPDC6HK	8.75
1"	0482641	PPDC8HK	12.51

Vinyl Dust Plug



0482725

Size	Part No.	Dust Plug	Price /Each
1/8"	0482725	PSDC1HK	\$6.14
1/4"	0482726	PSDC2HK	4.66
3/8"	0482727	PSDC3HK	6.14
1/2"	0482728	PSDC4HK	6.31
3/4"	0482729	PSDC6HK	9.97
1"	0482730	PSDC8HK	11.58

Hydraulic (Double Shut-Off) Quick Couplers -HA 15000 and A5600 Series

HA 15000 quick connects bring the user an unusual combination of advantageous features including: high flow rate, low pressure drop, interchangeability with leading "general purpose" couplers and superior trouble-free performance. Meets, or exceeds, ISO 7241-1 Series "A" specifications.

General Purpose ISO "A"

Interchanges with: Acroquip 5600; Parker 6600 Series

Temperature: -40°F to +225°F

Note: Heavy duty plugs are manufactured from high-strength steel and induction hardened. They are ideal for high cycling applications.



HA15000 Series Standard Plug

Hose I.D.	Part No.	Vendor No.	Price /Each
1/4"	0482642	HA1521200	\$4.85
3/8"	0482643	HA1522200	9.58
1/2"	0482644	HA1523200	9.78
3/4"	0482645	HA1524200	19.24
1"	0482646	HA1525200	22.32

A5600 Series Heavy Duty Plug

Tomco A5600 and Hansen HA 15000 series components are fully interchangeable.



Hose I.D.	Vendor Part No.	Price No.	/Each
1/2"	0482647	PA5604-26HD	\$12.80
3/4"	0482648	PA5606-31HD	23.17
1"	0482649	PA5608-36HD	28.57

TUTHILL Coupling Group | Hansen Couplings
Coupleurs Gromelle

HA 15000 Series Coupler



0482650

Size	Part No.	Vendor No.	Price /Each
1/4"	0482650	HA1521100	\$12.18
3/8"	0482651	HA1522100	21.49
1/2"	0482652	HA1532100	21.27
3/4"	0482653	HA1542100	35.60
1"	0482654	HA1552100	49.00

HYDRAULIC (DOUBLE SHUT-OFF) QUICK COUPLERS

Hydraulic (Double Shut-Off) Quick Couplers Cont.

Couple Under Pressure - Series A5100

TOMCO Series A5100 quick-couplers are engineered to provide the extra assembly forces required to make or break connection against trapped or active hydraulic pressures up to 500 psi.

Working Range: Maximum Operating Pressure; See Pressure Chart
Temperature: -40°F to +225°F
Standard Seals: Bonded Nitrile

Pressure Ratings

Hose I.D.	Working Pressure (PSI)	Burst Strength (PSI)
3/4"	3,000	9,000
1"	3,000	9,000
1-1/4"	2,750	8,250

Disconnected burst strength of plugs 51P-20 and 51PF-20 is 7,500 psi.



Plug Without Flange



Coupler with "Wings"

Hose I.D.	Plug Without Flange			Plug With Flange			Coupler With "Wings"			Coupler With Hex Nut		
	Part No.	Vendor No.	Price /Each	Part No.	Vendor No.	Price /Each	Part No.	Vendor No.	Price /Each	Part No.	Vendor No.	Price /Each
3/4"	0482655	51P-12	\$39.11	0482658	51PF-12	\$44.87	0482661	51W-12	\$51.29			
1"	0482656	51P-16	39.11	0482659	51PF-16	42.26	0482662	51W-16	53.60	0482665	51H-16	57.30
1-1/4"	0482657	51P-20	96.88	0482660	51PF-20	103.24	0482663	51W-20	100.20	0482666	51H-20	118.64

Suitable for coupling and uncoupling at pressures up to 500 psi

Flo-Temp Quick Couplers and Plugs

- Non-valved straight-through models for maximum flow
- Sockets with straight, 90° and 45° hose stems and without hose stem
- Brass plugs with male pipe thread to recessed mounting to avoid damage to plugs when molds are being changed or stored
- Brass socket construction
- Stainless steel springs and locking balls
- Viton seals (-30°F to +450)
- Brass and zinc-plated steel plugs

Flo-Temp couplings provide the flow needed to cool or heat injection molds and die casting dies. Sockets are available nonvalved for maximum flow. Flo-Temp couplings can be used with water-glycol, hot water and hot oil. Body sizes are 1/4", 3/8" and 1/2".

Note: Valved bodies are also available. Ask your local Fastenal representative.

1/4" Straight Through (Non-Valved) Flo-Temp Coupler

Fits Hose	Body Only (Brass)			Straight Stem (Brass)			90° Stem (Brass)			45° Stem (Brass)		
	Part No.	Vendor No.	Price /Each	Part No.	Vendor No.	Price /Each	Part No.	Vendor No.	Price /Each	Part No.	Vendor No.	Price /Each
1/4"	0482667	LNFT200	\$6.86	0482668	FTS204	\$5.12	0482673	FTS214	\$7.21	0482678	FTS224	\$7.87
1/4" (Push-On)				0482669	FTS204HP	5.19	0482674	FTS214HP	8.40	0482679	FTS224HP	8.24
3/8"				0482671	FTS206	5.45	0482676	FTS216	6.24	0482681	FTS226	7.02
3/8" (Push On)				0482672	FTS206HP	5.90	0482677	FTS216	8.52	0482682	FTS226HP	10.29



TUTHILL Coupling Group | Hansen Couplings Coupleurs Gromelle

3/8" Straight Through (Non-Valved) Flo-Temp Coupler

Fits Hose	Body Only (Brass)			Straight Stem (Brass)			90° Stem (Brass)			45° Stem (Brass)		
	Part No.	Vendor No.	Price /Each	Part No.	Vendor No.	Price /Each	Part No.	Vendor No.	Price /Each	Part No.	Vendor No.	Price /Each
3/8"	0482683	LNFT600	\$7.69	0482685	FTS306	\$6.78	0482690	FTS316	\$10.25	0482695	FTS326	\$10.97
3/8" (Push-On)				0482686	FTS306HP	7.37	0482691	FTS316HP	10.97	0482696	FTS326HP	11.69
1/2"				0482687	FTS308	6.86	0482692	FTS318	10.06	0482697	FTS328	10.97
1/2" (Push-On)				0482688	FTS308HP	7.56	0482693	FTS318HP	10.32	0482698	FTS328HP	10.97
1/2" (High Flow)	0482684	MC300HF*	5.72	0482689	MC308HF	7.28	0482694	MC318HF	8.25			



1/2" Straight Through (Non-Valved) Couplers

Fits Hose	Body Only (Brass)		Straight Stem (Brass)		90° Stem (Brass)		45° Stem (Brass)	
	Part No.	Price /Each	Part No.	Price /Each	Part No.	Price /Each	Part No.	Price /Each
1/2"	0482700	\$15.15	0482701	\$16.48	0482704	\$19.71	0482707	\$26.69
1/2" (Push-On)			0482702	18.13	0482705	20.32		
3/4"			0482703	16.78	0482706	20.37	0482709	23.23



HYD QUICK COUPLERS & CAM & GROOVE COUPLINGS

Hydraulic (Double Shut-Off) Quick Couplers Cont.



Non-Valved Mold Plugs

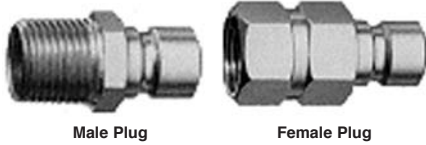

		Male Plug (Brass)		Female Plug (Steel)	
Basic Size	Size	Part No.	Price /Each	Part No.	Price /Each
1/4"	1/8" NPTF	0482710	\$1.05	0482713	\$2.69
1/4"	1/4" NPTF	0482711	1.46	0482714	1.46
1/4"	3/8" NPTF	0482712	1.39	0482715	1.75
3/8"	1/4" NPTF	0482716	1.39	0482719	1.62
3/8"	3/8" NPTF	0482717	1.55	0482720	3.35
3/8"	1/2" NPTF	0482718	2.80		
1/2"	1/2" NPTF	0482721	4.23	0482723	4.89
1/2"	3/4" NPTF	0482722	6.13	0482724	7.73

Double Shut-Off Flat Face Dripless Coupler

Temperature: -40°F to +225°F
Pressure Rating: 3000 psi



Size	Female Thread	Part No.	Price /Each
1/4"	1/4" NPTF	0482731	\$49.49
3/8"	3/8" NPTF	0482732	48.80
3/8"	3/4-16 UNF	0482733	52.80
3/8"	1/2" NPTF	0482734	44.49
1/2"	1/2" NPTF	0482735	60.92
1/2"	1-1/16" - 12" UNF	0482736	62.38
3/4"	3/4" NPTF	0482737	115.06
1"	1" NPTF	0482738	185.86

Dripless Plug

Temperature: -40°F to +225°F
Pressure Rating: 3000 psi



Size	Female Thread	Part No.	Price /Each
3/8"	3/8" NPTF	0482740	\$16.25
3/8"	3/4"-16 UNF	0482741	16.49
3/8"	1/2" NPTF	0482742	17.48
1/2"	1/2" NPTF	0482743	30.33
1/2"	1-1/16" UNF	0482744	31.94
3/4"	3/4" NPTF	0482745	72.07
1"	1" NPTF	0482746	111.43



Pioneer 4000 Series Interchange Coupler with Hardened Steel Poppets

Features: Double shut-off, general purpose.
Temperature: -40°F to +225°F
Pressure Rating: 3000 psi



Size	Female Thread	Part No.	Vendor No.	Price /Each
1/4"	1/4" NPTF	0482747	C2-16	\$13.55
3/8"	3/8" NPTF	0482748	C3-21	14.51
1/2"	3/4"-16 UNF (ORB)	0482749	C4-8	16.97
1/2"	7/8"-14 UNF (ORB)	0482750	C4-10	17.68
1/2"	1/2" NPTF	0482751	C4-26	15.07
1/2"	3/4" NPTF	0482752	C4-31	20.39
3/4"	3/4" NPTF	0482753	C6-36	51.68
1"	1" NPTF	0482754	C8-36	64.11

Plug with Hardened Steel Poppets

Features: Double shut-off, general purpose.
Temperature: -40°F to +225°F
Pressure Rating: 3000 psi



Size	Female Thread	Part No.	Vendor No.	Price /Each
1/4"	1/4" NPTF	0482755	P2-16	\$6.08
3/8"	3/8" NPTF	0482756	P3-21	6.96
1/2"	3/4"-16 UNF (ORB)	0482757	P4-8	7.61
1/2"	7/8"-14 UNF (ORB)	0482758	P4-10	7.84
1/2"	1/2" NPTF	0482759	P4-26	6.18
1/2"	3/4" NPTF	0482760	P4-31	7.79
3/4"	3/4" NPTF	0482761	P6-31	23.82
1"	1" NPTF	0482762	P8-8	29.05

Cam and Groove Couplings (Hose & Pipe)



Premium Cam and Groove Couplings (Hose and Pipe) Part A



Male x Female NPT	Aluminum		Stainless Steel	
	Part No.	Price /Each	Part No.	Price /Each
3/4"	0400500	\$4.49	0400656	\$12.44
1"	0400501	4.64	0400657	15.62
1-1/4"	0400502	5.40	0400658	19.56
1-1/2"	400441	4.64	0400659	21.37
2"	400442	6.18	0400660	26.39
2-1/2"	0400503	8.20	0400661	47.30
3"	400443	10.30	0400662	54.33
4"	400444	20.60	0400663	96.22
5"	0400504	34.25		
6"	0400505	40.98	0400664	165.81

Part B Female x Male NPT



Size	Aluminum		Stainless Steel	
	Part No.	Price /Each	Part No.	Price /Each
3/4"	0400507	\$9.53	0400665	\$21.59
1"	0400508	11.85	0400666	23.85
1-1/4"	0400509	12.50	0400667	34.28
1-1/2"	400445	10.98	0400668	34.93
2"	400446	12.88	0400669	43.45
2-1/2"	0400510	19.00	0400670	58.80
3"	400447	19.87	0400671	72.43
4"	400448	26.89	0400672	104.49
6"	0400512	64.50		

Part C



Female x Hose Shank	Aluminum		Stainless Steel	
	Part No.	Price /Each	Part No.	Price /Each
3/4"	0400513	\$7.99	0400674	\$19.98
1"	0400514	9.79	0400675	22.27
1-1/4"	0400515	10.25	0400676	34.40
1-1/2"	400449	10.80	0400677	34.97
2"	400450	13.91	0400678	42.50
2-1/2"	0400516	18.50	0400679	49.98
3"	400451	22.15	0400680	84.75
4"	400452	32.52	0400681	113.37
5"	0400517	56.27		
6"	0400518	61.75	0400682	284.33

Part D



Female x Female NPT	Aluminum		Stainless Steel	
	Part No.	Price /Each	Part No.	Price /Each
3/4"	0400520	\$10.65	0400683	\$21.87
1"	0400521	10.56	0400684	23.85
1-1/4"	0400522	11.50	0400685	36.82
1-1/2"	400453	11.39	0400686	36.82
2"	400454	13.39	0400687	44.29
2-1/2"	0400523	22.50	0400688	59.88
3"	400455	20.45	0400689	74.67
4"	400456	29.56	0400690	115.45
5"	0400524	59.50		
6"	0400525	74.90		

Industrial Hose Accessories

CAM & GROOVE COUPLINGS (HOSE & PIPE)

Cam and Groove Couplings (Hose & Pipe)



Part E



Male x Hose Shank	Aluminum		Stainless Steel	
	Part No.	Price /Each	Part No.	Price /Each
3/4	0400527	\$4.64	0400692	\$11.29
1	0400528	4.90	0400693	16.98
1-1/4	0400529	5.25	0400694	23.56
1-1/2	0400530	5.93	0400695	23.85
2	0400531	7.47	0400696	33.65
2-1/2	0400532	12.25	0400697	49.65
3	0400533	13.39	0400698	69.25
4	0400534	24.92	0400699	99.97
5	0400535	44.27		
6	0400536	49.87		

Part F



Male x Male NPT	Aluminum		Stainless Steel	
	Part No.	Price /Each	Part No.	Price /Each
3/4	0400537	\$4.25	0400701	\$14.84
1	0400538	4.90	0400702	20.75
1-1/4	0400539	6.99	0400703	28.25
1-1/2	0400540	6.25	0400704	30.55
2	0400541	7.73	0400705	37.25
2-1/2	0400542	14.50	0400706	57.95
3	0400543	16.48	0400707	71.87
4	0400544	23.98	0400708	96.69
6	0400546	56.65		

Part DC (Dust Cap)



Dust Cap	Aluminum		Stainless Steel	
	Part No.	Price /Each	Part No.	Price /Each
3/4	0400547	\$7.73	0400710	\$18.85
1	0400548	9.75	0400711	20.55
1-1/4	0400549	9.97	0400712	33.69
1-1/2	0400550	9.79	0400713	33.65
2	0400551	11.85	0400714	38.55
2-1/2	0400552	14.75	0400715	48.65
3	0400553	17.63	0400716	61.65
4	0400554	23.45	0400717	87.95
5	0400555	43.79		
6	0400556	56.75		

Part DP (Dust Plug)



Dust Plug	Aluminum		Stainless Steel	
	Part No.	Price /Each	Part No.	Price /Each
3/4	0400558	\$3.94	0400719	\$7.65
1	0400559	4.10	0400720	14.82
1-1/4	0400560	4.20	0400721	19.25
1-1/2	0400561	4.25	0400722	18.97
2	0400562	4.87	0400723	22.38
2-1/2	0400563	7.25	0400724	42.65
3	0400564	7.55	0400725	47.43
4	0400565	13.92	0400726	54.88
5	0400566	26.92		
6	0400567	31.50		

Cam and Groove Gaskets



Size	Buna-N		Viton	
	Part No.	Price /Each	Part No.	Price /Each
3/4	0400728	\$0.57	0400742	\$3.99
1	0400729	0.57	0400743	6.10
1-1/4	0400730	0.57	0400744	8.58
1-1/2	0400731	0.55	0400745	8.79
2	0400732	0.54	0400746	9.97
2-1/2	0400733	0.94	0400747	15.29
3	0400734	0.99	0400748	13.79
4	0400735	1.43	0400749	25.74
5	0400736	3.64		
6	0400737	4.69		

Extra Thick Cam and Groove Gaskets



Size	Part No.	Price /Each
1-1/2	0400738	\$2.52
2	0400739	1.43
3	0400740	2.34
4	0400741	1.95

Nylon & Polypropylene cam & groove fittings are also available. Please contact your local Fastenal Representative for more information.

Utility Grade Cam and Groove Couplings Part A



Male x Female NPT	Aluminum		Stainless Steel	
	Part No.	Price /ea	Part No.	Price /ea
1.5	0401565	\$4.20	0401595	\$18.56
2	0401566	4.56	0401596	20.35
3	0401567	9.28	0401597	42.62
4	0401568	15.90		

Part B Female x Male NPT



Size	Aluminum		Stainless Steel	
	Part No.	Price /ea	Part No.	Price /ea
1-1/2	0401569	\$9.44	0401599	\$32.48
2	0401570	10.40	0401600	35.20
3	0401571	17.88	0401601	62.50
4	0401572	27.20		

Part C



Female x Hose Shank	Aluminum	
	Part No.	Price /ea
1.5	0401573	\$9.80
2	0401574	11.48
3	0401575	19.80
4	0401576	29.50

Part D



Female x Female NPT	Aluminum		Stainless Steel	
	Part No.	Price /ea	Part No.	Price /ea
2	0401578	\$11.60	0401608	\$38.24
3	0401579	20.44		
4	0401580	29.20		

COUPLINGS, CROWFOOT FITTINGS & HOSE CLAMPS

Cam and Groove Couplings (Hose & Pipe) Cont.



Part E



Male x Hose Shank	Aluminum		Stainless Steel	
	Part No.	Price /ea	Part No.	Price /ea
2	0401581	\$6.56	0401612	\$29.20
3	0401582	13.20		

Part F



Male x Male NPT	Aluminum		Stainless Steel	
	Part No.	Price /ea	Part No.	Price /ea
1.5	0401583	\$5.72	0401615	\$24.76
2	0401584	6.60	0401616	29.87
3	0401585	14.94		
4	0401586	19.75		

Dust Cap



Dust Cap	Aluminum		Stainless Steel	
	Part No.	Price /ea	Part No.	Price /ea
1.5			0401619	\$26.90
2	0401588	9.60	0401620	30.21
3	0401589	16.20	0401621	54.28
4	0401590	22.94		

Dust Plug



Dust Plug	Aluminum		Stainless Steel	
	Part No.	Price /ea	Part No.	Price /ea
1.5	0401591	\$3.84		
2	0401592	4.60	0401624	19.40
3	0401593	7.56		
4	0401594	13.60		

Chicago/Universal Fittings (Crowfoot Fittings)



Hose End



Size	Part No.	Price /Each
3/8	0400568	\$3.66
1/2"	0400569	3.34
3/4"	400457	3.25
1"	0400571	3.98

Female



Size	Part No.	Price /Each
1/4	0400572	\$3.45
3/8	0400573	4.42
1/2"	0400574	3.50
3/4"	0400575	3.58
1"	0400576	4.58

Male



Size	Part No.	Price /Each
1/4	0400577	\$3.55
3/8	0400578	3.97
1/2"	0400579	3.54
3/4"	0400580	3.76
1"	0400581	4.38

4-Lug Hose End



Size	Part No.	Price /Each
1-1/4	0400582	\$9.27
1-1/2	0400583	9.85
2	0400584	13.35

4-Lug Female



Size	Part No.	Price /Each
1-1/4	0400585	\$8.78
1-1/2	0400586	8.64
2	0400587	11.25

Accessories



Description	Part No.	Price /Each
3-WAY Connector	0400588	\$7.25
Dead End	0400589	4.99
2-Lug Gaskets	0400590	0.31
4-Lug Gaskets	0400591	1.24
Safety Clip & Lanyard	0400592	0.35
Safety Clip only	0400593	0.17
Lanyard only	0400594	0.24

King Nipples

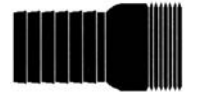

Size	Part No.	Price /Each
1/2	0400615	\$1.79
3/4	0400616	1.85
1	0400617	2.15
1-1/4	0400618	2.79
1-1/2	0400619	3.55
2	0400620	4.99
2-1/2	0400621	6.97
3	0400622	9.25
4	0400623	14.33
6	0400625	47.32

Suction Hose Strainers

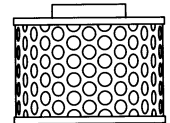

Part No.	Description	Price /Each
400483	1-1/2 Strainer	\$11.27
400484	2 Strainer	16.61
400485	3 Strainer	23.88
400486	4 Strainer	26.50

Hose Clamps



62 P Series: 5/16" stainless steel band and housing; 1/4" plated hex head screw

62 M Series: 5/16" all 300 series stainless steel band, housing, and 1/4" 300 series marine grade stainless steel hex head screw

Micro-Gear® Clamps

Trade Size	Min. Dia.	Max. Dia.	Pkg. Qty.	62 P Series			62 M Series		
				Part No.	Vendor No.	Price /Each	Part No.	Vendor No.	Price /Each
4	1/4"	5/8"	10	62002	6202/6204	\$0.74	0427670	62602/62604	\$0.79
6	5/16"	7/8"	10	62003	6203/6206	0.77	0427671	62606	0.81
8	3/8	1	10	62004	62P08	0.77	0427672	62M08	0.85
12	1/2	1-1/4	10	62005	62P12	0.79	0427673	62M12	0.86
16	1/2	1-1/2	10	62006	62P16	0.79	0427674	62M16	0.86
20	3/4	1-3/4	10	0427667	62P20	0.81	0427675	62M20	0.86
24	1	2	10	0427668	62P24	0.81	0427676	62M24	0.86
30	1-3/8	2-3/8	10	0427669	62P30	0.81	0427677	62M30	0.87



HOSE CLAMPS

Hose Clamps Cont.

Industrial Hose Accessories



1/2" Wide Clamps

57 Series: 1/2" stainless steel band and housing; 5/16" plated hex screw

67-1 Series: 1/2" stainless steel band, housing, and 5/16" hex screw

67-5 Series: 1/2" all high-nickel, corrosion resistant stainless steel band, housing and 5.16" hex screw



Trade Size	Min. Dia.	Max. Dia.	Pkg. Qty.	57 Series			67-1 Series			67-5 Series		
				Part No.	Vendor No.	Price /Each	Part No.	Vendor No.	Price /Each	Part No.	Vendor No.	Price /Each
06	3/8	7/8	10	0427607	5706	\$0.63	0427627	6706-1	\$0.81	0427647	6706-5	\$0.89
08	7/16	1	10	0427608	5708	0.63	0427628	6708-1	0.81	0427648	6708-5	0.89
10	1/2	1-1/16	10	0427609	5710	0.63	0427629	6710-1	0.81	0427649	6710-5	0.91
12	1/2	1-1/4	10	0427610	5712	0.63	0427630	6712-1	0.81	0427650	6712-5	0.92
16	11/16	1-1/2	10	0427611	5716	0.63	0427631	6716-1	0.82	0427651	6716-5	0.92
20	3/4	1-3/4	10	0427612	5720	0.63	0427632	6720-1	0.82	0427652	6720-5	0.95
24	1	2	10	0427613	5724	0.63	0427633	6724-1	0.82	0427653	6724-5	0.95
28	1-1/4	2-1/4	10	0427614	5728	0.63	0427634	6728-1	0.85	0427654	6728-5	0.95
32	1-1/2	2-1/2	10	0427615	5732	0.63	0427635	6732-1	0.85	0427655	6732-5	0.99
36	1-3/4	2-3/4	10	0427616	5736	0.69	0427636	6736-1	0.85	0427656	6736-5	0.99
40	2	3	10	0427617	5740	0.82	0427637	6740-1	0.88	0427657	6740-5	1.28
44	2-1/4	3-1/4	10	0427618	5744	0.88	0427638	6744-1	0.99	0427658	6744-5	1.34
48	2-1/2	3-1/2	10	0427619	5748	0.88	0427639	6748-1	0.99	0427659	6748-5	1.14
52	2-3/4	3-3/4	10	0427620	5752	0.95	0427640	6752-1	1.06	0427660	6752-5	1.14
56	3	4	10	0427621	5756	0.95	0427641	6756-1	1.06	0427661	6756-5	1.20
64	2-1/2	4-1/2	10	0427622	5764	0.99	0427642	6764-1	1.20	0427662	6764-5	1.34
72	3	5	10	0427623	5772	1.14	0427643	6772-1	1.28	0427663	6772-5	1.40
80	3-1/2	5-1/2	10	0427624	5780	1.28	0427644	6780-1	1.34	0427664	6780-5	1.51
88	4	6	10	0427625	5788	1.28	0427645	6788-1	1.40	0427665	6788-5	1.65
96	4-1/2	6-1/2	10	0427626	5796	1.28	0427646	6796-1	1.72	0427666	6796-5	1.65

9/16" Wide Clamps

50 Series: 9/16" stainless steel band and housing; 5/16" plated hex head screw

63 Series: 9/16" all high-nickel, corrosion resistant stainless steel band, housing and 5/16" hex screw

68 Series: 9/16" stainless steel band, housing, and 5/16" hex head screw



Trade Size	Min. Dia.	Max. Dia.	Pkg. Qty.	50 Series			63 Series			68 Series		
				Part No.	Vendor No.	Price /Each	Part No.	Vendor No.	Price /Each	Part No.	Vendor No.	Price /Each
06	3/8"	7/8"	10	62008	5006	\$0.82	62079	6306	\$1.06	62038	6806	\$0.89
08	7/16"	1"	10	62009	5008	0.82	62062	6308	1.06	62039	6808	0.89
10	1/2"	1-1/16"	10	62010	5010	0.82	62063	6310	1.06	62040	6810	0.89
12	1/2"	1-1/4"	10	62011	5012	0.82	62064	6312	1.10	62041	6812	0.89
16	11/16"	1-1/2"	10	62012	5016	0.82	62065	6316	1.10	62042	6816	0.97
20	3/4"	1-3/4"	10	62013	5020	0.82	62066	6320	1.11	62043	6820	0.97
24	1"	2"	10	62014	5024	0.82	62067	6324	1.15	62044	6824	0.97
28	1-1/4"	2-1/4"	10	62015	5028	0.89	62090	6328	1.20	62045	6828	0.97
32	1-1/2"	2-1/2"	10	62016	5032	0.89	62091	6332	1.20	62046	6832	1.04
36	1-3/4"	2-3/4"	10	62017	5036	0.89	62092	6336	1.25	62047	6836	1.04
40	2"	3"	10	62018	5040	1.04	62068	6340	1.34	62048	6840	1.12
44	2-1/4"	3-1/4"	10	62019	5044	1.12	62080	6344	1.45	62049	6844	1.19
48	2-1/2"	3-1/2"	10	62020	5048	1.12	62081	6348	1.45	62050	6848	1.20
52	2-3/4"	3-3/4"	10	62021	5052	1.19	62069	6352	1.59	62051	6852	1.27
56	3"	4"	10	62022	5056	1.19	62095	6356	1.59	62052	6856	1.34
64	2-1/2"	4-1/2"	10	62024	5064	1.33	62082	6364	1.72	62054	6864	1.39
72	3"	5"	10	62025	5072	1.54	62097	6372	1.83	62055	6872	1.69
80	3-1/2"	5-1/2"	10	62026	5080	1.64	62098	6380	2.03	62056	6880	1.74
88	4"	6"	10	62027	5088	1.64	62099	6388	2.08	62057	6888	1.74
96	4-1/2"	6-1/2"	10	62028	5096	1.67	0427603	6396	1.83	62058	6896	1.75
104	5"	7"	10	62029	50104	1.87	0427604	63104	2.08	62059	68104	1.98
128	2-1/2	8-1/2	10				0427605	63128	3.40			
152	2	10	10				0427606	63152	3.59			

Hose Clamps Cont.



Pow'r Gear® High Torque Clamps

60 Series: 5/8" band, heavy duty housing, 5/16" screw. All stainless steel.

6L Series: 5/8" lined band, heavy duty housing, 5/16" screw. All stainless steel.



Industrial Hose Accessories

Trade Size	Min. Dia.	Max. Dia.	Pkg. Qty.	60 Series			6L Series		
				Part No.	Vendor No.	Price /Each	Part No.	Vendor No.	Price /Each
175	1	1-3/4	10	0427678	60175	\$2.52	0427688	6L175	\$2.70
212	1-1/4	2-1/8	10	0427679	60200	2.52	0427689	6L200	2.70
262	1-3/4	2-5/8	10	0427680	60250	2.54	0427690	6L250	2.71
312	2-1/4	3-1/8	10	0427681	60300	2.76	0427691	6L300	2.95
362	2-3/4	3-5/8	10	62304	60350	2.81	0427692	6L350	3.01
412	3-1/4	4-1/8	10	62305	60400	2.84	0427693	6L400	3.04
462	3-3/4	4-5/8	10	62306	60450	2.93	0427694	6L450	3.13
512	4-1/4	5-1/8	10	62307	60500	3.07	0427695	6L500	3.28
562	4-3/4	5-5/8	10	0427682	60550	3.10	0427696	6L550	3.31
612	5-1/4	6-1/8	5	62308	60600	3.17	0427697	6L600	3.39
662	5-3/4	6-5/8	5	0427683	60650	3.47	0427698	6L650	3.71
712	6-1/4	7-1/8	5	62309	60700	3.59	0427699	6L700	3.84
762	6-3/4	7-5/8	5	0427684	60750	3.88	0427700	6L750	4.15
812	7-1/4	8-1/8	5	0427685	60800	3.95	0427701	6L800	4.23
862	7-3/4	8-5/8	5	0427686	60850	4.03	0427702	6L850	4.32
912	8-1/4	9-1/8	5	0427687	60900	4.12	0427703	6L900	4.41



Ideal has a clamp for virtually any industrial application - full size, miniature size, and high performance designs like our incredibly strong POW'R-GEAR®. We also offer specialty clamps, such as lined, marine grade, air conditioning, T-Bolts and our Snaplock® series.

A Tomkins Company ©2007

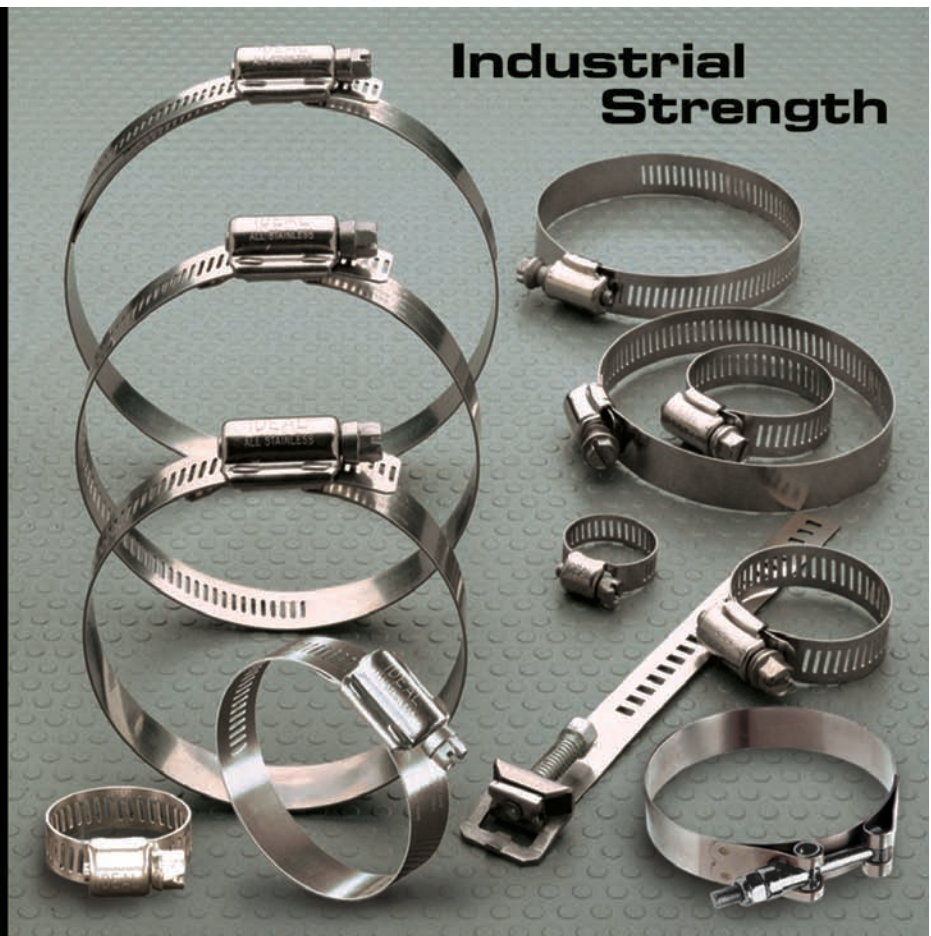

HOSE CLAMPS

Hose Clamps Cont.



Snaplock® Quick Release Clamps

56 Series: 9/16" stainless steel band, swivel housing; plated 5/16" screw

58 Series: 9/16" stainless steel band, swivel housing; 3/8" stainless steel screw



Trade Size	Min. Dia.	Max. Dia.	Pkg. Qty.	56 Series			58 Series		
				Part No.	Vendor No.	Price /Each	Part No.	Vendor No.	Price /Each
12	1/2	1-1/4	10	62250	5612	\$1.81	0427704	5812	\$1.66
20	3/4	1-3/4	10	62251	5620	1.59	0427705	5820	1.75
28	1	2-1/4	10	62252	5628	1.62	0427706	5828	1.72
36	1	2-3/4	10	62253	5636	1.65	0427707	5836	1.83
48	1-1/2	3-1/2	10	62254	5648	1.68	0427708	5848	2.15
56	1	4	10	62255	5656	1.75	0427709	5856	2.21
72	2	5	10	62256	5672	1.89	0427710	5872	2.72
88	2	6	10	62257	5688	2.21	0427711	5888	2.99
104	1-3/4	7	10	62258	56104	2.27	0427712	58104	3.28
116	1-3/4	7-3/4	5				0427713	58116	3.59
128	2-1/4	8-1/2	10	62259	56128	2.97	0427714	58128	3.65
152	2	10	10	62260	56152	3.02	0427715	58152	3.96
188	2	12-1/4	10	62261	56188	3.09	0427716	58188	4.40

Flexible Shaft Hose Clamp Driver

- Flexes 90 degrees and comes with a reversible socket drive for 1/4" and 5/16" hex heads.
- Fits typical mini and standard size hex heads.
- Great for work in tight spaces like compact car and boat engines, irrigation systems, etc.
- Heavy Duty Construction
- Flexible shaft up to 90 degrees.
- Extra grip on handle.



Part No.	Vendor No.	Description	Price /Each
0401024	800019999058	1/4 or 5/16 Interchangeable Flexible Shaft Hose Clamp Driver	\$9.25

Flex-Gear HD® Constant Tension Clamps

5/8" heavy-duty 300 series stainless steel band, spring and liner; 3/8" 410 stainless steel hex head screw



Trade Size	Min. Dia.	Max. Dia.	Pkg. Qty.	Part No.	Vendor No.	Price /Each
175	1	1-3/4	10	0427717	45175	\$6.26
212	1-1/4	2-1/8	10	0427718	45200	6.33
262	1-3/4	2-5/8	10	0427719	45250	6.64
312	2-1/4	3-1/8	10	0427720	45300	6.71
362	2-3/4	3-5/8	10	0427721	45350	6.72
412	3-1/4	4-1/8	10	0427722	45400	6.76
462	3-3/4	4-5/8	10	0427723	45450	6.92
512	4-1/4	5-1/8	10	0427724	45500	6.94
562	4-3/4	5-5/8	10	0427725	45550	6.99
612	5-1/4	6-1/8	10	0427726	45600	6.99
662	5-3/4	6-5/8	10	0427727	45650	7.11
712	6-1/4	7-1/8	10	0427728	45700	7.22
762	6-3/4	7-5/8	10	0427729	45750	7.28
812	7-1/4	8-1/8	10	0427730	45800	7.36
862	7-3/4	8-5/8	10	0427731	45850	7.46
912	8-1/4	9-1/8	10	0427732	45900	7.56

Flex-Gear® Light Duty Constant Tension Clamps

9/16" light duty 300 series stainless steel band, spring and liner; 5/16" 410 stainless steel hex head screw



Trade Size	Min. Dia.	Max. Dia.	Pkg. Qty.	Part No.	Vendor No.	Price /Each
10	9/16	1-1/16	10	0427733	47010	\$3.81
12	5/8	1-1/4	10	0427734	47012	3.99
16	13/16	1-1/2	10	0427735	47016	4.11
20	13/16	1-3/4	10	0427736	47020	4.24
24	1-1/16	2	10	0427737	47024	4.36
28	1-5/16	2-1/4	10	0427738	47028	4.37
32	1-9/16	2-1/2	10	0427739	47032	4.56
36	1-13/16	2-3/4	10	0427740	47036	4.57
40	2-1/16	3	10	0427741	47040	4.61
44	2-5/16	3-1/4	10	0427742	47044	5.80
48	2-9/16	3-1/2	10	0427743	47048	5.86

Hose Clamp Rack Kits - Stainless Steel Small Diameters

PART NO. 99357

Use in conjunction with storage rack Part No. 62968 (sold separately)

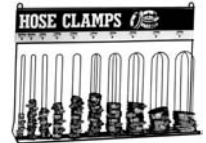

Part No.	Description	Price /Each
99357	Hose Clamp Assortment	\$59.35
62968	Rack for 99357	34.96

Hose clamp assortment contains the following clamps:

Part No.	Trade Size	Min. Diameter	Max. Diameter	Pkg. Qty.	Vendor No.
62002	micro 4	1/4	5/8	10	6202/6204
62003	micro 6	5/16	7/8	10	6203/6206
62008	06	3/8	7/8	10	5006
62010	10	1/2	1-1/16	10	5010
62011	12	1/2	1-1/4	10	5012
62012	16	11/16	1-1/2	10	5016
62013	20	3/4	1-3/4	10	5020
62015	28	1-1/4	2-1/4	10	5028
62016	32	1-1/2	2-1/2	10	5032
62017	36	1-3/4	2-3/4	10	5036

Hose Clamp Rack Kits (Large) Large Diameters

PART NO. 99360

Use in conjunction with storage rack Part No. 62967 (sold separately)

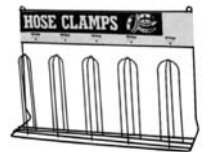

Part No.	Description	Price /Each
99360	Hose Clamp Assortment	\$51.96
62967	Rack for 99360	34.96

Hose clamp assortment contains the following clamps:

Part No.	Vendor No.	Trade Size	Min. Diameter	Max. Diameter	Pkg. Qty.
62018	5040	40	2	3	10
62020	5048	48	2-1/2	3-1/2	10
62021	5052	52	2-3/4	3-3/4	10
62022	5056	56	3	4	10
62025	5072	72	3	5	10

T-BOLT, TURNKEY AND OETIKER HOSE CLAMPS

Hose Clamps Cont.

BREEZE

Breeze Make-A-Clamp



Part No.	Vendor No.	Description	Price /Each
62070	4000	Mini Kit, 8-1/2 ft. band, 3 adj. fasteners, 1 band splice	\$14.45
62071	4001	Kit with 100 ft. band, 25 adj. fasteners, 10 band splices	114.47
62072	4002	Kit with 50 ft. band, 10 adj. fasteners, 5 band splices	53.64
62073	4003	Adj. Fasteners	2.31
62074	4004	10' Adj. Fasteners	2.41
62075	4005	Box with 100 ft. band, 10 band splices	57.75
62076	4006	Box with 50 ft. band, 5 band splices	31.26
62078	4008	Splices	2.22



Turn Key® Clamps

Innovative design installs with a simple hand twist, no tools required. Easy to remove and replace. Pull off the screw cap for a tamper-resistant connection. Installation torque: 30-35 in.-lbs.; 3.4 - 4.0 Nm

- Injection molded thermoplastic screw cap, removable and reusable.
- Screw: Plated carbon steel
- Band: 1/2" band width. 201/301 stainless steel
- Housing: 201/301 stainless steel



Part No.	Vendor No.	Pkg. Qty.	Trade Size	Price /Each
0401018	6B00458	2 of each	Micros 4 & 6	\$2.45
0401019	5B01258	2 Pcs	12	1.99
0401020	5B02058	2 Pcs	20	2.25
0401021	5B02858	2 Pcs	28	2.25
0401022	5B03658	2 Pcs	36	2.39
0401023	5B00158	6 Pcs	Micros 4,6,12,20,28,36	6.89

T-Bolt Clamps



Stainless Steel band with zinc coated T-bolt. For permanent or semi-permanent applications and/or safety on pressurized systems.

Size	Range min.-max. (in)	Part No.	Price /Each
1-1/2	1.375 - 1.625	0427926	\$2.99
1-3/4	1.625 - 1.875	0427927	2.99
2	1.875 - 2.125	0427928	3.99
2-1/8	2.000-2.3125	0427929	3.99
2-1/4	2.0625-2.375	0427930	3.27
2-3/8	2.125-2.4375	0427931	3.29
2-1/2	2.25-2.5625	0427932	3.32
2-5/8	2.375-2.6875	0427933	3.34
2-7/8	2.625-2.9375	0427934	5.73
3	2.75-3.0625	0427935	3.40
3-1/8	2.875-3.1875	0427936	3.42
3-1/4	3.000-3.3125	0427937	3.30
3-1/2	3.25-3.5625	0427938	3.46
4	3.75-4.0625	0427939	3.35
4-1/2	4.25-4.5625	0427940	3.55
5	4.75-5.0625	0427941	3.60
5-1/2	5.25-5.5625	0427942	4.97
6	5.75-6.0625	0427943	3.73
6-1/2	6.25-6.5625	0427944	3.63
7	6.75-7.0625	0427945	3.70

Oetiker Clamps



Stepless Ear Clamps

- Precise tongue-in-groove stepless design provides smooth inner circumference for 360° uniform seal
- Narrow band for concentrated seal compression
- Smooth-edged bandsteel prevents damage to hose
- Lightweight, strong low clearance design
- Tampering is visible
- Stainless steel

Size	Part No.	Vendor No.	Price /Each
1/4	0427970	16702487	\$0.32
9/32	0427971	16700983	0.33
5/16	0427972	16700984	0.33
11/32	0427973	16700985	0.33
3/8	0427974	16700986	0.33
25/64	0427975	16700987	0.33
13/32	0427976	16700988	0.33
27/64	0427977	16702614	0.33
7/16	0427978	16700989	0.35
29/64	0427979	16700990	0.34
15/32	0427980	16700992	0.37
31/64	0427981	16702490	0.36
1/2	0427982	16700993	0.36
17/32	0427983	16700995	0.36
35/64	0427984	16700997	0.36
9/16	0427985	16700999	0.37
19/32	0427986	16701002	0.40
5/8	0427987	16701005	0.40
21/32	0427988	16702544	0.40
11/16	0427989	16701009	0.42
23/32	0427990	16701015	0.42
3/4	0427991	16701021	0.43
13/16	0427992	16701029	0.42
7/8	0427993	16701041	0.48
15/16	0427994	16701058	0.48
1	0427995	16701072	0.48

2-Ear Clamps

- Robust, durable one-piece design offers positive, tamper resistant seal
- For air and fluid media lines
- Quick and easy installation
- Smooth edges prevent damage to hose
- Zinc-plated



Size	Part No.	Vendor No.	Price /Each
5/32	0427954	10100000	\$0.27
11/64	0427955	10100001	0.27
3/16	0427956	10100002	0.27
1/4	0427957	10100004	0.31
5/16	0427958	10100008	0.31
3/8	0427959	10100011	0.31
1/2	0427961	10100016	0.31
9/16	0427962	10100019	0.32
9/32	0427963	10100022	0.34
5/8	0427964	10100024	0.34
3/4	0427965	10100027	0.35
13/16	0427966	10100029	0.37
7/8	0427967	10100030	0.40
15/16	0427968	10100032	0.45
1	0427969	10100034	0.47
1-1/16	0427952	10100035	0.49
1-1/8	0427951	10100037	0.51
1-5/16	0427949	10100041	0.53
1-7/16	0427948	10100043	0.62
1-1/2	0427953	10100045	0.58
1-5/8	0427947	10100047	0.60
1-3/4	0427946	10100049	0.62

Clamp Maintenance Kits

Service Kit Contains:

Clamps: 15 each of sizes 5/16", 3/8", 1/2", 9/16" and 5/8". 12 of each of sizes 3/4", 7/8", 15/16", 1" and 1 pair of pincers.

Large Service/Maintenance kit contains:

50 of 3/8", 50 of 1/2", 50 of 9/16"
50 of 5/8", 25 of 3/4", 25 of 7/8"
5 of 1/4", 5 of 5/16", 5 of 3/8"
5 of 1/2", Hose menders and 1 pair pincers.

Part No.	Vendor No.	Description	Price /Each
0427996	18500130	123 pc. Service Kit with 1 pair Pincers	\$87.75
0427997	18500045	270 pc. Large Service Maintenance Clamp Kit	199.55

Stepless® Ear Clamp Kit

- 81 Piece
- 1/2" to 1-1/4" w/ Standard Jaw Pincer
- Stepless® Ear Clamps (Stainless Steel)
- 360° Seal



Stepless® Ear Clamp Kit Contains:

10 each: 1/2", 9/16", 5/8", 23/32", 7/8", 1", 1-1/8", 1-1/4", and one pair of pincers

Part No.	Vendor No.	Product	Price /EA
0400401	18500060	81 Piece Stepless® Ear Clamp Kit	\$69.50

Pincers



Part No.	Vendor No.	Description	Price /Each
0427999	14100083	Side Jaw Pincer	\$37.33
0427998	14100082	Standard Jaw Pincer	32.05

The : symbol after a price denotes that it is a Direct Ship Product (DSP) and shipping, availability & lead times may vary.

BANDING COILS & BUCKLES AND SOLID SHAFT COLLARS

Banding Coils and Buckles



Stainless Bands

- 201 Stainless steel
- 100 foot rolls
- Color coded for easy identification



Part No.	Vendor No.	Type	Thickness	Width	Weight (lbs)	Breaking Strength	Price
62103	C202		.20	1/4	1.7	500	\$54.71
62104	C203		.25	3/8	3.2	900	71.03
62105	C204		.30	1/2	5.1	1500	96.01
62106	C205		.30	5/8	6.4	1875	116.57
62107	C206		.30	3/4	7.7	2250	143.25

Stainless Buckles



Part No.	Vendor No.	Type	Size	Price
62108	C252	201 Stainless Steel	1/4	\$0.45
62109	C253	201 Stainless Steel	3/8	0.49
62110	C254	201 Stainless Steel	1/2	0.66
62111	C255	201 Stainless Steel	5/8	0.82
62112	C256	201 Stainless Steel	3/4	1.01

Galvanized Bands



Part No.	Vendor No.	Type	Thickness	Width	Weight (lbs)	Breaking Strength	Price
62114	C304	Carbon Steel	.030	1/2	5.1	1125	\$51.02
62115	C306	Carbon Steel	.030	3/4	7.7	1690	74.59

Galvanized Buckles



Part No.	Vendor No.	Type	Size	Price
62117	C354	Carbon Steel	1/2	\$0.42
62118	C356	Carbon Steel	3/4	0.83

Band-It Tool

Drop forged tool with built-in cutter tensions over 2,400 lbs. Spring-loaded gripper lever and friction-held cutoff lever with plastic grip improves ease-of-use. Blue, epoxy powder coated finish minimizes impact, chemical, and corrosive elements. Use to apply band, strapping, and Free-End Clamps.



Part No.	Vendor No.	Weight (lbs)	Price
62102	C001	4.4	\$160.50

Shaft Collars

Zinc Steel Solid Collars

- Set Screw Collar
- Traditional cost effective collar design
- Zinc plated steel



I.D.	O.D.	Width	Vendor No.	Climax Brand Domestic		Fastenal Quality Import	
				Part No.	Price /Ea	Part No.	Price /Ea
1/8	3/8	1/4	C-012	0402911	\$0.75	33364	\$0.67
3/16	7/16	1/4	C-018	0402912	0.75	33365	0.67
1/4	1/2	5/16	C-025	0402913	0.75	33370	0.67
5/16	5/8	5/16	C-031	0402914	0.81	33371	0.72
3/8	3/4	3/8	C-037	0402915	0.86	33372	0.77
7/16	7/8	7/16	C-043	0402916	1.10	33373	0.99
1/2	1"	7/16"	C-050	0402917	1.03	33374	0.93
9/16	1	7/16	C-056	0402918	1.16	33366	1.05
5/8	1-1/8	1/2	C-062	0402919	1.22	33375	1.09
11/16	1-1/4	9/16	C-068	0402920	1.61	33367	1.45
3/4	1-1/4	9/16	C-075	0402921	1.48	33376	1.33
13/16	1-1/4	9/16	C-081	0402922	1.85	33368	1.67
7/8	1-1/2	9/16	C-087	0402923	1.81	33377	1.63
15/16	1-1/2	9/16	C-093	0402924	2.00	33369	1.80
1	1-1/2"	5/8"	C-100	0402925	1.81	33378	1.63
1-1/16	1-3/4	5/8	C-106	0402926	3.13	33361	2.82
1-1/8	1-3/4	5/8	C-112	0402927	3.06	33382	2.75
1-3/16	2	11/16	C-118	0402928	3.68	33383	3.31
1-1/4	2	11/16	C-125	0402929	3.51	33379	3.15
1-5/16	2-1/8	11/16	C-131	0402930	4.38	33381	3.94
1-3/8	2-1/8	3/4	C-137	0402931	3.92	33392	3.52
1-7/16	2-1/4	3/4	C-143	0402932	4.29	33393	3.86
1-1/2	2-1/4	3/4	C-150	0402933	4.22	33380	3.77
1-9/16	2-1/2	13/16				33402	4.97
1-5/8	2-1/2	13/16	C-162	0402934	6.06	33403	5.45
1-11/16	2-1/2	13/16	C-168	0402935	6.27	33597	5.64
1-3/16	2-5/8	7/8	C-175	0402936	7.15	33578	6.44
1-3/4	2-3/4	7/8				33565	7.79
1-7/8	2-3/4	7/8	C-187	0402937	8.48	33566	7.63
1-15/16	3	7/8	C-193	0402938	9.30	33567	8.37
2	3	7/8	C-200	0402939	9.65	33568	8.69
2-1/8	3	7/8	C-212	0402940	10.15	33569	9.14
2-3/16	3-1/4	15/16	C-218	0402941	11.07	33598	9.96
2-1/4	3-1/4	15/16	C-225	0402942	11.80	33570	10.62
2-5/16	3-1/4	15/16				33571	10.37
2-3/8	3-1/4	15/16	C-237	0402943	12.54	33572	11.26
2-7/16	3-1/2	1	C-243	0402944	12.52	33599	11.27
2-1/2	3-1/2	1	C-250	0402945	12.52	33573	11.27
2-9/16	3-3/4	1				33600	18.00
2-5/8	4	1-1/8	C-262	0402946	22.12	33657	19.91
2-11/16	4	1-1/8				33658	18.21
2-3/4	4	1-1/8	C-275	0402947	22.82	33574	20.52
2-7/8	4	1-1/8	C-287	0402948	28.74	33679	25.85
2-15/16	4	1-1/8	C-293	0402949	26.13	33680	23.52
3	4	1-1/8	C-300	0402950	26.13	33575	23.52
3-1/4	4-1/4	1-1/8				0403383	41.29
3-7/16	4-1/2	1-1/8				0403384	41.29
3-1/2	4-3/4	1-1/8				0403385	41.29
3-15/16	5	1-1/8				0403386	51.43
4	5	1-1/8				0403387	66.08
4-3/16	5-1/2	1-1/8				0403388	66.08
4-1/4	5-1/2	1-1/8				0403389	66.08
4-7/16	5-1/2	1-1/8				0403390	66.08
4-1/2	5-1/2	1-1/4				0403391	66.08
4-15/16	6	1-1/4				0403393	79.84

SOLID & ONE PIECE SPLIT

Shaft Collars Cont.

Stainless Steel Solid Collar

- Set Screw Collar
- Traditional cost effective collar design
- Stainless Steel



Black Oxide Steel Split 1 Piece Collar

- Design fully engages shaft without marring
- Greater axial holding power than set screw collars
- Effective on hard & soft shafts; Black Oxide Steel



Power Drive



I.D.	O.D.	Width	Vendor No.	Climax Brand Domestic		Fastenal Quality Import	
				Part No.	Price /Ea	Part No.	Price /Ea
1/8"	3/8"	1/4"	C-012-S	0402951	\$2.63	34223	\$2.37
3/16"	7/16"	1/4"	C-018-S	0402952	2.43	34224	2.19
1/4"	1/2"	5/16"	C-025-S	0402953	2.37	34225	2.15
5/16"	5/8"	5/16"	C-031-S	0402954	2.57	34226	2.32
3/8"	3/4"	3/8"	C-037-S	0402955	2.82	34227	2.55
7/16"	7/8"	7/16"	C-043-S	0402956	3.40	34228	2.99
1/2"	1"	7/16"	C-050-S	0402957	3.48	34229	3.14
9/16"	1"	7/16"	C-056-S	0402958	4.30	34230	3.89
5/8"	1-1/8"	1/2"	C-062-S	0402959	4.38	34231	3.95
11/16"	1-1/4"	9/16"	C-068-S	0402960	5.96	34232	5.37
3/4"	1-1/4"	9/16"	C-075-S	0402961	5.32	34233	4.79
13/16"	1-1/4"	9/16"	C-081-S	0402962	7.34	34234	6.59
7/8"	1-1/2"	9/16"	C-087-S	0402963	7.97	34235	7.25
15/16"	1-1/2"	9/16"	C-093-S	0402964	10.03	34236	9.15
1"	1-1/2"	5/8"	C-100-S	0402965	9.40	34237	8.49
1-1/16"	1-3/4"	5/8"	C-106-S	0402966	12.95	34238	11.70
1-1/8"	1-3/4"	5/8"	C-112-S	0402967	12.14	34239	10.97
1-3/16"	2"	11/16"	C-118-S	0402968	14.63	34240	13.25
1-1/4"	2"	11/16"	C-125-S	0402969	15.22	34241	13.75
1-5/16"	2-1/8"	11/16"				34242	14.07
1-3/8"	2-1/8"	3/4"				34243	14.25
1-7/16"	2-1/4"	3/4"	C-143-S	0402970	18.91	34244	17.22
1-1/2"	2-1/4"	3/4"	C-150-S	0402971	18.19	34245	16.45
1-9/16"	2-1/2"	13/16"				34246	19.55
1-5/8"	2-1/2"	13/16"	C-162-S	0402972	25.10	34247	22.69
1-11/16"	2-1/2"	13/16"				34248	20.18
1-3/4"	2-5/8"	7/8"	C-175-S	0402973	32.78	34249	29.63
1-13/16"	2-3/4"	7/8"				34250	26.78
1-7/8"	2-3/4"	7/8"				34251	30.05
1-15/16"	3"	7/8"	C-193-S	0402974	40.90	34252	36.97
2"	3"	7/8"	C-200-S	0402975	39.34	34253	35.55



I.D.	O.D.	Width	Vendor No.	Climax Brand Domestic		Fastenal Quality Import	
				Part No.	Price /Each	Part No.	Price /Each
1/8"	11/16"	5/16"				34259	\$2.37
3/16"	11/16"	5/16"				34260	2.37
1/4"	11/16"	5/16"	1C-025	0402800	2.32	34261	1.98
5/16"	11/16"	5/16"	1C-031	0402801	2.32	34262	1.98
3/8"	7/8"	3/8"	1C-037	0402802	2.32	34263	1.99
7/16"	15/16"	3/8"	1C-043	0402803	2.94	34264	2.65
1/2"	1-1/8"	13/32"	1C-050	0402804	2.70	34265	2.44
9/16"	1-5/16"	7/16"				34266	3.06
5/8"	1-5/16"	7/16"	1C-062	0402805	3.45	34267	3.15
11/16"	1-1/2"	1/2"				34268	3.50
3/4"	1-1/2"	1/2"	1C-075	0402806	3.83	34269	3.45
13/16"	1-5/8"	1/2"				34270	5.75
7/8"	1-5/8"	1/2"	1C-087	0402807	4.57	34271	4.15
15/16"	1-3/4"	1/2"	1C-093	0402808	5.67	34272	5.16
1"	1-3/4"	1/2"	1C-100	0402809	4.67	34273	4.22
1-1/16"	1-7/8"	1/2"				34274	5.42
1-1/8"	1-7/8"	1/2"	1C-112	0402810	5.91	34275	5.34
1-3/16"	2-1/16"	1/2"	1C-118	0402811	6.22	34276	5.65
1-1/4"	2-1/16"	1/2"	1C-125	0402812	5.73	34277	5.25
1-5/16"	2-1/4"	9/16"	1C-131	0402813	7.35	34278	6.65
1-3/8"	2-1/4"	9/16"	1C-137	0402814	6.68	34279	5.98
1-7/16"	2-1/4"	9/16"	1C-143	0402815	7.03	34280	6.35
1-1/2"	2-3/8"	9/16"	1C-150	0402816	6.99	34281	6.32
1-9/16"	2-3/8"	9/16"				34282	9.44
1-5/8"	2-5/8"	11/16"	1C-162	0402817	12.87	34283	11.65
1-11/16"	2-3/4"	11/16"				34284	11.91
1-3/4"	2-3/4"	11/16"	1C-175	0402818	12.36	34285	11.22
1-7/8"	2-7/8"	11/16"				34286	13.63
1-15/16"	3"	11/16"	1C-193	0402819	14.73	34287	13.35
2"	3"	11/16"	1C-200	0402820	13.98	34288	12.65
2-1/8"	3-1/4"	3/4"	1C-212	0402821	17.31	34289	15.66
2-3/16"	3-1/4"	3/4"	1C-218	0402822	17.67	34290	15.97
2-1/4"	3-1/4"	3/4"	1C-225	0402823	18.05	34291	16.33
2-3/8"	3-1/2"	3/4"	1C-237	0402824	19.89	34292	17.98
2-7/16"	3-1/2"	3/4"	1C-243	0402825	19.91	0403433	17.99
2-1/2"	3-3/4"	7/8"	1C-250	0402826	30.09	34293	27.20
2-3/4"	4"	7/8"	1C-275	0402827	34.97	34295	31.55
2-15/16"	4-1/4"	7/8"	1C-293	0402828	39.35	0403435	35.50
3"	4-1/4"	7/8"	1C-300	0402829	38.26	34297	34.59

The : symbol after a price denotes that it is a Direct Ship Product (DSP) and shipping, availability & lead times may vary.

ONE PIECE & TWO PIECE SPLIT SHAFT COLLARS

Shaft Collars Cont.

Stainless Steel Split - One Piece Collar

- Design fully engages shaft without marring
- Greater axial holding power than set screw collars
- Effective on hard & soft shafts; Stainless Steel



I.D.	O.D.	Width	Vendor No.	Climax Brand Domestic		Fastenal Quality Import	
				Part No.	Price /Each	Part No.	Price /Each
1/8"	11/16	5/16				34461	\$3.61
3/16"	11/16	5/16				34462	3.76
1/4"	11/16"	5/16"	1C-025-S	0402830	4.43	34463	3.95
5/16"	11/16"	5/16"	1C-031-S	0402831	4.61	34464	4.15
3/8"	7/8"	3/8"	1C-037-S	0402832	5.77	34465	5.13
7/16"	15/16"	3/8"	1C-043-S	0402833	6.35	34466	5.65
1/2"	1-1/8"	13/32"	1C-050-S	0402834	7.31	34467	6.51
9/16"	1-5/16"	7/16"	1C-056-S	0402835	8.43	34468	7.49
5/8"	1-5/16"	7/16"	1C-062-S	0402836	8.18	34469	7.29
11/16"	1-1/2"	1/2"				34470	7.91
3/4"	1-1/2"	1/2"	1C-075-S	0402837	9.75	34471	8.67
15/16"	1-3/4"	1/2"	1C-093-S	0402838	16.26	0403737	14.49
1"	1-3/4"	1/2"	1C-100-S	0402839	11.98	34473	1.65
1-1/8"	1-7/8"	1/2"	1C-112-S	0402840	14.66	34474	12.98
1-3/16"	2-1/16"	1/2"				34475	14.08
1-1/4"	2-1/16"	1/2"	1C-125-S	0402841	16.41	34476	14.65
1-3/8"	2-1/4"	9/16"	1C-137-S	0402842	20.64	34477	18.25
1-7/16"	2-1/4"	9/16"	1C-143-S	0402843	20.64	34478	18.25
1-1/2"	2-3/8"	9/16"	1C-150-S	0402844	21.99	34479	19.57
1-5/8"	2-5/8"	11/16"	1C-162-S	0402845	51.18	0403751	45.55
1-3/4"	2-3/4"	11/16"	1C-175-S	0402846	42.42	34480	37.75
1-7/8"	2-7/8"	11/16"				34481	39.32
1-15/16"	3"	11/16"	1C-193-S	0402847	50.89	34482	45.29
2"	3"	11/16"	1C-200-S	0402848	48.34	34483	42.99

Black Oxide Steel- Two Piece Split Collar

- Design fully engages the shaft without marring
- Easily installed with limited disassembly required
- Effective on hard & soft shafts; Black Oxide Steel



I.D.	O.D.	Width	Vendor No.	Climax Brand Domestic		Fastenal Quality Import		
				Part No.	Price /Each	Part No.	Price /Each	
1/8"	11/16	5/16					34298	\$6.27
3/16"	11/16	5/16					34299	4.02
1/4"	11/16"	5/16"	2C-025	0402849	4.58		34300	3.95
5/16"	11/16"	5/16"	2C-031	0402850	4.65		34301	4.15
3/8"	7/8"	3/8"	2C-037	0402851	4.17		34302	3.71
7/16"	15/16"	3/8"	2C-043	0402852	4.41		34303	3.92
1/2"	1-1/8"	13/32"	2C-050	0402853	4.29		34304	3.81
9/16"	1-5/16"	7/16"	2C-056	0402854	5.32		34305	4.74
5/8"	1-5/16"	7/16"	2C-062	0402855	5.12		34306	4.55
11/16"	1-1/2"	1/2"	2C-068	0402856	6.19		34307	5.50
3/4"	1-1/2"	1/2"	2C-075	0402857	5.96		34308	5.35
13/16"	1-5/8"	1/2"					34309	6.17
7/8"	1-5/8"	1/2"	2C-087	0402858	6.57		34310	5.85
15/16"	1-3/4"	1/2"	2C-093	0402859	7.90		34311	6.98
1"	1-3/4"	1/2"	2C-100	0402860	6.48		34312	5.77
1-1/16"	1-7/8"	1/2"	2C-106	0402861	8.07		34313	7.22
1-1/8"	1-7/8"	1/2"	2C-112	0402862	7.86		34314	6.99
1-3/16"	2-1/16"	1/2"					34315	7.58
1-1/4"	2-1/16"	1/2"	2C-125	0402863	7.70		34316	6.85
1-5/16"	2-1/4"	9/16"	2C-131	0402864	9.19		34317	8.22
1-3/8"	2-1/4"	9/16"	2C-137	0402865	8.68		34318	7.73
1-7/16"	2-1/4"	9/16"	2C-143	0402866	8.68		34319	7.73
1-1/2"	2-3/8"	9/16"	2C-150	0402867	8.68		34320	7.73
1-9/16"	2-3/8"	9/16"	2C-156	0402868	15.47		34321	13.76
1-5/8"	2-5/8"	11/16"	2C-162	0402869	15.47		34322	13.76
1-11/16"	2-3/4"	11/16"	2C-168	0402870	15.83		34323	13.97
1-3/4"	2-3/4"	11/16"	2C-175	0402871	14.31		34324	12.73
1-7/8"	2-7/8"	11/16"	2C-187	0402872	17.67		34325	15.75
1-15/16"	3"	11/16"	2C-193	0402873	16.60		34326	14.77
2"	3"	11/16"	2C-200	0402874	15.93		34327	14.23
2-1/8"	3-1/4"	3/4"	2C-212	0402875	18.76		34328	16.79
2-3/16"	3-1/4"	3/4"	2C-218	0402876	19.69		34329	17.49
2-1/4"	3-1/4"	3/4"	2C-225	0402877	19.14		34330	16.97
2-3/8"	3-1/2"	3/4"	2C-237	0402878	21.01		34331	18.69
2-7/16"	3-1/2"	3/4"	2C-243	0402879	23.94		0403440	21.35
2-1/2"	3-3/4"	7/8"	2C-250	0402880	34.92		34332	31.30
2-5/8"	3-7/8"	7/8"	2C-262	0402881	42.31		34333	37.65
2-3/4"	4"	7/8"	2C-275	0402882	44.16		34334	39.25
2-15/16"	4-1/4"	7/8"	2C-293	0402883	42.93		0403442	38.29
3"	4-1/4"	7/8"	2C-300	0402884	42.93		34336	38.29
3-3/16"	4-1/2"	7/8"					0403402	36.27
3-1/4"	4-1/2"	7/8"					0403403	37.20
3-7/16"	4-3/4"	7/8"					0403404	40.29
3-1/2"	4-3/4"	7/8"					0403405	39.19
3-15/16"	5-1/4"	7/8"					0403406	60.81
4"	5-1/4"	7/8"					0403407	69.47
4-1/4"	5-1/2"	7/8"					0403408	60.53
4-7/16"	5-3/4"	7/8"					0403409	90.80
4-1/2"	5-3/4"	7/8"					0403410	94.43
4-15/16"	6-1/4"	7/8"					0403411	110.08
5"	6-1/4"	7/8"					0403412	107.79
5-1/2"	6-3/4"	7/8"					0403413	123.83
5-15/16"	7-1/4"	7/8"					0403414	151.41
6"	7-1/4"	7/8"					0403415	151.41

SPLIT & RECESSED SCREW SHAFT COLLARS

Shaft Collars Cont.

Split - Two Piece Stainless Steel Split Collar



I.D.	O.D.	Width	Vendor No.	Climax Brand Domestic		Fastenal Quality Import	
				Part No.	Price /Each	Part No.	Price /Each
1/8	11/16	5/16				34484	\$7.34
3/16	11/16	5/16				34485	7.36
1/4	11/16	5/16	2C-025-S	0402885	6.54	34486	5.83
5/16	11/16	5/16	2C-031-S	0402886	6.96	34487	6.21
3/8	7/8	3/8	2C-037-S	0402887	8.72	34488	7.78
7/16	15/16	3/8	2C-043-S	0402888	9.07	34489	8.10
1/2	1-1/8	13/32	2C-050-S	0402889	10.19	34490	9.10
9/16	1-5/16	7/16	2C-056-S	0402890	12.21	34491	10.87
5/8	1-5/16	7/16	2C-062-S	0402891	12.56	34492	11.25
11/16	1-1/2	1/2				34493	15.66
3/4	1-1/2	1/2	2C-075-S	0402892	13.33	34494	11.85
7/8	1-5/8	1/2	2C-087-S	0402893	14.90	34495	13.25
1	1-3/4	1/2	2C-100-S	0402894	16.13	34496	14.36
1-1/8	1-7/8	1/2	2C-112-S	0402895	19.10	34497	16.99
1-3/16	2-1/16	1/2	2C-118-S	0402896	21.02	34498	18.72
1-1/4	2-1/16	1/2	2C-125-S	0402897	20.27	34499	17.98
1-3/8	2-1/4	9/16	2C-137-S	0402898	25.45	34500	22.65
1-7/16	2-1/4	9/16	2C-143-S	0402899	25.45	34501	22.65
1-1/2	2-3/8	9/16	2C-150-S	0402900	26.62	34502	23.69
1-5/8	2-5/8	11/16	2C-162-S	0402901	48.96	0403416	43.55
1-3/4	2-3/4	11/16	2C-175-S	0402902	47.99	34503	42.69
1-7/8	2-7/8	11/16	2C-187-S	0402903	57.84	34504	51.50
1-15/16	3	11/16	2C-193-S	0402904	56.97	34505	51.20
2	3	11/16	2C-200-S	0402905	56.97	34506	51.20
2-1/4	3-1/4	3/4	2C-225-S	0402906	81.01	0403418	71.97
2-3/8	3-1/2	3/4	2C-237-S	0402907	86.77	0403419	77.25
2-1/2	3-3/4	7/8	2C-250-S	0402908	102.18	0403421	89.75

Split - Recessed Screw - One Piece Stainless Steel



Bore	O.D.	Width	Set Screw Size	Part No.	Price /Each
1/8	13/16	1/4	4-40	34415	\$6.89
3/16	13/16	1/4	4-40	34416	6.89
1/4	13/16	1/4	4-40	34417	6.22
5/16	13/16	1/4	4-40	34418	6.26
3/8	1-1/16	5/16	6-32	34419	6.89
7/16	1-1/16	5/16	6-32	34420	8.72
1/2	1-1/4	3/8	8-32	34421	8.11
9/16	1-1/4	3/8	8-32	34422	10.95
5/8	1-1/2	13/32	10-32	34423	10.75
3/4	1-3/4	1/2	1/4-28	34425	13.55
7/8	1-7/8	1/2	1/4-28	34426	15.95
1	2	1/2	1/4-28	34427	13.99
1-1/8	2-1/8	1/2	1/4-28	34428	19.22
1-3/16	2-1/8	1/2	1/4-28	34429	19.36
1-1/4	2-1/4	1/2	1/4-28	34430	17.65
1-7/16	2-3/8	1/2	1/4-28	34432	23.39
1-1/2	2-1/2	1/2	1/4-28	34433	23.25
1-15/16	3-1/4	5/8	5/16-24	34436	49.98
2	3-1/4	5/8	5/16-24	34437	47.65

Split - Recessed Screw - One Piece Black Oxide Steel



Bore	O.D.	Width	Set Screw Size	Part No.	Pkg. Qty.	Price /Each
1/8	13/16	1/4	4-40	34337	20	\$2.92
3/16	13/16	1/4	4-40	34338	20	2.62
1/4	13/16	1/4	4-40	34339	20	2.33
5/16	13/16	1/4	4-40	34340	20	2.38
3/8	1-1/16	5/16	6-32	34341	20	2.46
7/16	1-1/16	5/16	6-32	34342	20	2.65
1/2	1-1/4	3/8	8-32	34343	20	2.73
9/16	1-1/4	3/8	8-32	34344	20	3.45
5/8	1-1/2	13/32	10-32	34345	20	3.39
11/16	1-1/2	13/32	10-32	34346	20	3.94
3/4	1-3/4	1/2	1/4-28	34347	20	3.75
13/16	1-3/4	1/2	1/4-28	34348	20	6.15
7/8	1-7/8	1/2	1/4-28	34349	20	4.65
15/16	1-7/8	1/2	1/4-28	34350	20	5.45
1	2	1/2	1/4-28	34351	20	4.66
1-1/16	2	1/2	1/4-28	34352	10	5.93
1-1/8	2-1/8	1/2	1/4-28	34353	10	5.23
1-3/16	2-1/8	1/2	1/4-28	34354	10	5.33
1-1/4	2-1/4	1/2	1/4-28	34355	10	5.45
1-5/16	2-1/4	1/2	1/4-28	34356	10	6.30
1-3/8	2-3/8	1/2	1/4-28	34357	10	6.15
1-7/16	2-3/8	1/2	1/4-28	34358	10	6.15
1-1/2	2-1/2	1/2	1/4-28	34359	10	6.55
1-9/16	2-1/2	1/2	1/4-28	34360	10	9.62
1-5/8	3	5/8	5/16-24	34361	5	11.89
1-11/16	3	5/8	5/16-24	34362	5	13.55
1-3/4	3	5/8	5/16-24	34363	5	11.84
1-7/8	3-1/4	5/8	5/16-24	34364	5	14.25
1-15/16	3-1/4	5/8	5/16-24	34365	5	12.66
2	3-1/4	5/8	5/16-24	34366	5	12.67

Split - Recessed Screw - Two Piece Stainless Steel



Bore	O.D.	Width	Set Screw Size	Part No.	Price /Each
1/4	13/16	1/4	4-40	34440	\$7.24
5/16	13/16	1/4	4-40	34441	7.95
3/8	1-1/16	5/16	6-32	34442	7.98
7/16	1-1/16	5/16	6-32	34443	9.68
1/2	1-1/4	3/8	8-32	34444	9.70
5/8	1-1/2	13/32	10-32	34446	12.43
11/16	1-1/2	13/32	10-32	34447	16.99
3/4	1-3/4	1/2	1/4-28	34448	15.15
7/8	1-7/8	1/2	1/4-28	34449	16.39
1	2	1/2	1/4-28	34450	16.91
1-1/8	2-1/8	1/2	1/4-28	34451	20.75
1-1/4	2-1/4	1/2	1/4-28	34453	19.79
1-3/8	2-3/8	1/2	1/4-28	0404407	26.99
1-7/16	2-3/8	1/2	1/4-28	34455	22.23
1-1/2	2-1/2	1/2	1/4-28	34456	25.06
1-5/8	3	5/8	5/16-24	0404409	58.58
1-7/8	3-1/4	5/8	5/16-24	34458	52.63
1-15/16	3-1/4	5/8	5/16-24	34459	48.77
2	3-1/4	5/8	5/16-24	34460	48.77

Power Drive

METRIC SHAFT COLLARS & SET SCREW COUPLINGS

Shaft Collars Cont.



Split - Recessed Screw - Two Piece Black Oxide Steel



Bore	O.D.	Width	Set Screw Size	Part No.	Pkg. Qty.	Price /Each
1/8	13/16	1/4	4-40	34376	20	\$6.15
3/16	13/16	1/4	4-40	34377	20	5.19
1/4	13/16	1/4	4-40	34378	20	4.82
5/16	13/16	1/4	4-40	34379	20	4.94
3/8	1-1/16	5/16	6-32	34380	20	4.97
7/16	1-1/16	5/16	6-32	34381	20	5.22
1/2	1-1/4	3/8	8-32	34382	20	4.92
9/16	1-1/4	3/8	8-32	34383	20	5.54
5/8	1-1/2	13/32	10-32	34384	20	5.55
11/16	1-1/2	13/32	10-32	34385	20	5.79
3/4	1-3/4	1/2	1/4-28	34386	20	5.87
13/16	1-3/4	1/2	1/4-28	34387	20	7.23
7/8	1-7/8	1/2	1/4-28	34388	20	6.85
15/16	1-7/8	1/2	1/4-28	34389	20	7.76
1	2	1/2	1/4-28	34390	20	6.62
1-1/16	2	1/2	1/4-28	34391	10	7.23
1-1/8	2-1/8	1/2	1/4-28	34392	10	7.37
1-3/16	2-1/8	1/2	1/4-28	34393	10	7.37
1-1/4	2-1/4	1/2	1/4-28	34394	10	7.52
1-5/16	2-1/4	1/2	1/4-28	34395	10	8.91
1-3/8	2-3/8	1/2	1/4-28	34396	10	8.78
1-7/16	2-3/8	1/2	1/4-28	34397	10	8.78
1-1/2	2-1/2	1/2	1/4-28	34398	10	8.91
1-9/16	2-1/2	1/2	1/4-28	34399	10	10.65
1-5/8	3	5/8	5/16-24	34400	5	13.79
1-11/16	3	5/8	5/16-24	34401	5	14.47
1-3/4	3	5/8	5/16-24	34402	5	12.98
1-7/8	3-1/4	5/8	5/16-24	34403	5	16.25
1-15/16	3-1/4	5/8	5/16-24	34404	5	14.33
2	3-1/4	5/8	5/16-24	34405	5	14.33

Metric - Solid - Black Oxide Steel



Bore	O.D.	Width	Set Screw Size	Part No.	Pkg. Qty.	Price /Each
4	8	5	M2 X 2.5	0403080	100	\$1.62
5	10	6	M 3 X 3	0403081	100	1.62
6	12	8	M 4 X 4	0403082	100	1.62
8	16	8	M 4 X 4	0403083	100	1.76
10	20	10	M 5 X 5	0403084	50	1.93
12	22	12	M 6 X 6	0403085	50	2.22
14	25	12	M 6 X 6	0403086	50	2.46
15	25	12	M 6 X 6	0403087	50	2.46
16	28	12	M 6 X 6	0403088	50	2.49
18	32	14	M 6 X 6	0403089	50	2.79
20	32	14	M 6 X 6	0403090	25	2.94
22	36	14	M 6 X 6	0403091	25	2.94
25	40	16	M 8 X 8	0403092	25	3.45
30	45	16	M 8 X 8	0403094	25	3.93
32	50	16	M 8 X 8	0403095	25	4.32
35	56	16	M 8 X 10	0403097	25	4.98
40	60	18	M 10 X 10	0403100	10	6.85
50	78	18	M 10 X 10	0403102	5	11.70

O.D. may be to the nearest inch equivalent. Some sizes available in stainless steel.

Metric - Split - One Piece Black Oxide Steel



Bore	O.D.	Width	Set Screw Size	Part No.	Pkg. Qty.	Price /Each
4	16	9	M 3 X 8	0403002	100	\$3.42
5	16	9	M 3 X 8	0403003	100	3.46
6	18	9	M 3 X 8	0403004	100	3.42
7	18	9	M 3 X 8	0403005	100	3.42
8	24	9	M 3 X 10	0403006	100	3.42
9	24	9	M 3 X 10	0403007	50	3.78
10	24	9	M 3 X 10	0403008	50	3.57
12	28	11	M 4 X 12	0403009	50	4.12
13	30	11	M 4 X 12	0403010	50	4.12
14	30	11	M 4 X 12	0403011	50	4.66
15	34	13	M 5 X 16	0403012	50	4.26
16	34	13	M 5 X 16	0403013	50	4.32
17	36	13	M 5 X 16	0403014	50	4.82
18	36	13	M 5 X 16	0403015	50	4.66
19	40	15	M 6 X 16	0403016	50	4.98
20	40	15	M 6 X 16	0403017	50	5.15
21	42	15	M 6 X 16	0403018	50	5.33
22	42	15	M 6 X 16	0403019	25	5.33
23	45	15	M 6 X 16	0403020	25	5.55
25	45	15	M 6 X 16	0403021	25	5.55
26	48	15	M 6 X 16	0403022	25	7.37
30	54	15	M 6 X 16	0403023	25	7.37
35	57	15	M 6 X 16	0403024	25	7.99
36	57	15	M 6 X 16	0403025	25	9.29
40	60	15	M 6 X 16	0403026	25	9.29
42	73	19	M 8 X 25	0403027	10	15.25
45	73	19	M 8 X 25	0403028	10	15.25
50	78	19	M 8 X 25	0403030	5	18.55
60	88	19	M 8 X 25	0403033	5	22.95
70	98	19	M 8 X 25	0403034	5	34.38
75	103	19	M 8 X 25	0403035	5	37.15

O.D. may be to the nearest inch equivalent. Some sizes available in Stainless Steel.

Solid Set Screw Couplings - Black Oxide Steel



Bore	O.D.	Width	Set Screw Size	Part No.	Pkg. Qty.	Price /Each
1/4	1/2	3/4	10-32	0403173	20	\$5.99
5/16	5/8	1	10-32	0403174	20	6.85
3/8	3/4	1	1/4-20	0403175	20	7.40
1/2	1	1-1/2	1/4-20	0403176	5	8.45
5/8	1-1/4	2	5-16-18	0403177	5	10.98
3/4	1-1/2	2	5/16-18	0403178	5	12.53
7/8	1-3/4	2	5/16-18	0403179	5	16.25
1	2	3	5/16-18	0403180	2	18.55
1-1/8	2-1/8	3	3/8-16	0403181	2	23.49
1-1/4	2-1/4	4	3/8-16	0403182	2	28.22
1-3/8	2-1/2	4-1/2	3/8-16	0403183	1	39.55
1-1/2	2-1/2	4-1/2	3/8-16	0403184	1	60.25

CLAMPING COUPLINGS & SHAFT COLLARS

Shaft Collars Cont.



Metric - Split - Two Piece Black Oxide Steel



Bore	O.D.	Width	Set Screw Size	Part No.	Pkg. Qty.	Price /Each
4	16	9	M 3 X 8	0403038	100	\$6.56
5	16	9	M 3 X 8	0403039	100	6.56
6	18	9	M 3 X 8	0403040	100	6.56
8	24	9	M 3 X 10	0403042	100	6.56
10	24	9	M 3 X 10	0403044	50	6.85
12	28	11	M 4 X 12	0403045	50	6.85
13	30	11	M 4 X 12	0403046	50	7.23
14	30	11	M 4 X 12	0403047	50	7.23
15	34	13	M 5 X 16	0403048	50	7.55
16	34	13	M 5 X 16	0403049	50	7.55
17	36	13	M 5 X 16	0403050	50	7.76
18	36	13	M 5 X 16	0403051	50	7.90
20	40	15	M 6 X 16	0403052	50	7.90
22	42	15	M 6 X 16	0403054	25	8.15
24	45	15	M 6 X 16	0403055	25	8.62
25	45	15	M 6 X 16	0403056	25	8.38
26	48	15	M 6 X 16	0403057	25	9.29
28	48	15	M 6 X 16	0403058	25	9.61
30	54	15	M 6 X 16	0403059	25	9.98
32	54	15	M 6 X 16	0403060	25	9.98
34	57	15	M 6 X 16	0403061	25	11.48
35	57	15	M 6 X 16	0403062	25	11.48
36	57	15	M 6 X 16	0403063	25	11.48
38	60	15	M 6 X 16	0403064	25	12.37

O.D. may be to the nearest inch equivalent. Some sizes available in stainless steel.

Bore	O.D.	Width	Set Screw Size	Part No.	Pkg. Qty.	Price /Each
40	60	15	M 6 X 16	0403065	25	\$12.39
42	73	19	M 8 X 25	0403066	10	18.21
45	73	19	M 8 X 25	0403067	10	19.22
48	78	19	M 8 X 25	0403068	10	20.62
50	78	19	M 8 X 25	0403069	5	22.36
54	82	19	M 8 X 25	0403070	5	26.20
55	82	19	M 8 X 25	0403071	5	26.20
60	88	19	M 8 X 25	0403072	5	27.50
65	93	19	M 8 X 25	0403073	5	42.98
70	98	19	M 8 X 25	0403074	5	42.14
75	103	19	M 8 X 25	0403075	5	48.12
80	108	19	M 8 X 25	0403076	5	62.36

Split - One Piece Clamping Couplings - Black Oxide Steel



Bore	O.D.	Width	Set Screw Size	Part No.	Pkg. Qty.	Price /Each
1/4 x 1/4	11/16	1-1/8	4-40	0403128	10	\$15.47
3/8 x 3/8	7/8	1-3/8	6-32	0403130	5	18.93
1/2 x 3/8	1-1/8	1-3/4	8-32	0403131	5	23.98
1/2 x 1/2	1-1/8	1-3/4	8-32	0403132	5	19.73
5/8 x 1/2	1-5/16	2	10-32	0403133	5	25.78
5/8 x 5/8	1-5/16	2	10-32	0403134	5	25.78
3/4 x 3/4	1-1/2	2-1/4	1/4-28	0403135	5	28.67
7/8 x 7/8	1-5/8	2-1/2	1/4-28	0403136	5	33.52
1 x 1/2	1-3/4	3	1/4-28	0403137	2	41.24
1 x 1	1-3/4	3	1/4-28	0403138	2	31.22
1-1/4 x 1-1/4	2-1/16	3-1/4	1/4-28	0403139	2	42.15

Power Drive

SHAFT COLLARS
RIGID COUPLINGS
KEYLESS LOCKING ASSEMBLIES
...from 2mm to 6" I.D.



**A Full Line Supplier • Stock Available From Fastenal Locations
Steel, Stainless Steel & Aluminum Available**

SHAFT COLLARS & JAW COUPLINGS

Shaft Collars Cont.



No Flange Self-Centering Keyless Locking Assembly

- Medium-High Torque
- Economical - Quick Installation - Compact Size
- Self-Centering Keyless Lock Assembly no Flange



Part No.	Vendor No.	I.D.	O.D.	Price /Each
0403600	C123E-075	0.75"	1.85"	\$39.42
0403602	C123E-100	1"	1.969"	43.22
0403604	C123E-125	1.125"	2.362"	49.70
0403606	C123E-143	1.437"	2.559"	50.66
0403607	C123E-150	1.5"	2.559"	50.85
0403610	C123E-193	1.937"	3.15"	61.24
0403611	C123E-200	2"	3.15"	61.40
0403931	C123E-243	2.437"	3.74"	81.75
0403937	C123E-293	2.937"	4.528"	132.74
0403938	C123E-300	3.00"	4.724"	133.12

Flanged Self-Centering Keyless Locking Assembly

- Medium-High Torque
- Economical - Quick Installation - Compact Size
- Self-Centering Keyless Lock Assembly with Flange



Part No.	Vendor No.	I.D.	O.D.	Price /Each
0403622	C133E-075	0.75"	1.85"	\$38.33
0403624	C133E-100	1"	1.969"	41.32
0403626	C133E-125	1.125"	2.362"	46.70
0403628	C133E-143	1.437"	2.559"	47.99
0403629	C133E-150	1.5"	2.559"	48.44
0403632	C133E-193	1.937"	3.15"	58.82
0403633	C133E-200	2"	3.15"	58.94
0403978	C133E-243	2.437"	3.74"	82.32
0403984	C133E-293	2.937"	4.528"	130.62
0403985	C133E-300	3.00"	4.724"	130.85

Self-Centering Keyless Locking Assembly

- Very high torque
- Compact size
- Excellent for bulk handling applications such as drum pulleys
- Ideal for component to shaft connections



Part No.	Vendor No.	I.D.	O.D.	Price /Each
0403666	C405E-100	1"	2.165"	\$91.40
0403670	C405E-150	1.5"	2.953"	137.09
0403672	C405E-175	1.75"	2.953"	152.67
0403673	C405E-193	1.937"	3.15"	170.65
0403674	C405E-200	2"	3.15"	162.18
0403678	C405E-243	2.437"	3.74"	192.50
0403679	C405E-250	2.5"	3.74"	192.50
0404188	C405E-275	2.75"	4.331"	271.38
0404190	C405E-293	2.937"	4.724"	283.50
0404191	C405E-300	3.00"	4.724"	295.37
0404195	C405E-343	3.437"	5.118"	326.69
0404196	C405E-350	3.50"	5.118"	326.69
0404200	C405E-393	3.937"	5.709"	417.95
0404201	C405E-400	4.000"	5.709"	510.94

Shaft Collar Kit

Use in conjunction with Insert card #99370 and drawer (not included)



Part No.	Description	Price /Each
99369	48 pieces; assorted sizes from 1/4 to 2, 2-piece double split	\$299.94

Power Transmission Couplings and Accessories



3 Piece Flexible Jaw Couplings (L Type)

- Coupling assemblies consist of 3 pieces, 2 jaws, and 1 insert (spider)

- Fail-safe - will still perform if elastomer fails
- No metal to metal contact
- Resistant to oil, dirt, sand, moisture, and grease
- The Jaw Type couplings from Lovejoy are offered in the industry's largest variety of stock bore/keyway combinations
- These couplings require no lubrication and provide highly reliable service for light, medium, and heavy duty electrical motor and internal combustion power transmission applications



Coupling Hubs

- Gray sintered iron (L050 to L150)
- Cast iron construction (L190)

- **Note: For complete assembly order 2 hubs and 1 insert (spider)**

Part No.	Vendor No.	Style	Bore Size	Description	Price /Ea
0439450	68514410206	L050	1/4"	No Keyway	\$3.26
0439451	68514410207	L050	5/16"	No Keyway	3.26
0439452	68514410208	L050	3/8"	No Keyway	3.26
0439454	68514410210	L050	1/2"	No Keyway	3.26
0439469	68514410420	L070	1/2"	No Keyway	5.06
0439471	68514410424	L070	5/8"	3/16 x 3/32 Keyway	5.06
0439484	68514410688	L075	5/8"	3/16 x 3/32 Keyway	5.82
0439485	68514410690	L075	3/4"	3/16 x 3/32 Keyway	5.82
0439500	68514410771	L090	5/8"	3/16 x 3/32 Keyway	8.93
0439501	68514410773	L090	3/4"	3/16 x 3/32 Keyway	8.93
0439508	68514411085	L095	5/8"	3/16 x 3/32 Keyway	13.74
0439509	68514411087	L095	3/4"	3/16 x 3/32 Keyway	13.74
0439510	68514411089	L095	7/8"	3/16 x 3/32 Keyway	13.74
0439511	68514411091	L095	1"	1/4 x 1/8 Keyway	13.74
0439526	68514411338	L099	3/4"	3/16 x 3/32 Keyway	17.35
0439529	68514411344	L099	1-1/8"	1/4 x 1/8 Keyway	17.35
0439533	68514411512	L100	3/4"	3/16 x 3/32 Keyway	25.68
0439536	68514411516	L100	1"	1/4 x 1/8 Keyway	25.68
0439537	68514411518	L100	1-1/8"	1/4 x 1/8 Keyway	25.68
0439539	68514411522	L100	1-3/8"	5/16 x 5/32 Keyway	25.68
0439549	68514411735	L110	3/4"	3/16 x 3/32 Keyway	35.11
0439552	68514411739	L110	1"	1/4 x 1/8 Keyway	35.11
0439553	68514411741	L110	1-1/8"	1/4 x 1/8 Keyway	35.11
0439555	68514411745	L110	1-3/8"	5/16 x 5/32 Keyway	35.11
0439558	68514411749	L110	1-5/8"	3/8 x 3/16 Keyway	35.11
0439567	68514412107	L150	1"	1/4 x 1/8 Keyway	44.94
0439568	68514412109	L150	1-1/8"	1/4 x 1/8 Keyway	44.94
0439570	68514412113	L150	1-3/8"	5/16 x 5/32 Keyway	44.94
0439572	68514412117	L150	1-5/8"	3/8 x 3/16 Keyway	44.94
0439573	68514412119	L150	1-3/4"	3/8 x 3/16 Keyway	44.94
0439578	68514412301	L190	1-7/8"	1/2 x 1/4 Keyway	70.23
0439579	68514412305	L190	2-1/8"	1/2 x 1/4 Keyway	70.23

COUPLING INSERTS & UNIVERSAL JOINTS

Power Transmission Couplings and Accessories Cont.



Buna-N Inserts (Spiders)

- Made of long life Buna-N rubber
- Flexible and oil resistant
- Temperature Range -40° to 212°F
- Shore Hardness: 80A
- Color: Black
- **Use in conjunction with 2 hubs for complete assembly**



Part No.	Vendor No.	Style	Torque	Price /Ea
0439446	68514410194	L050	26 inch-Lbs.	\$2.11
0439459	68514410406	L070	43 inch-Lbs.	3.01
0439475	68514410621	L075	90 inch-Lbs.	5.12
0439490	68514411070	L090/095	144/194 inch-Lbs.	6.62
0439515	68514411494	L099/100	318/417 inch-Lbs.	13.94
0439540	68514411724	L110	792 inch-Lbs.	16.05
0439559	68514412001	L150	1240 inch-Lbs.	23.07
0439575	68514412274	L190	1728 inch-Lbs.	28.09

Hytel Inserts (Spiders)

- Flexible elastomer designed for higher torque and wider temperature range
- Excellent resistance to oil and chemicals
- Temperature range -60° to 250°F
- Shore Hardness: 55D
- Color: Tan
- **Use in conjunction with 2 hubs for complete assembly**



Part No.	Vendor No.	Style	Torque	Price /Ea
0439463	68514425308	L070	114 inch-Lbs.	\$9.98
0439478	68514425309	L075	227 inch-Lbs.	15.05
0439493	68514425310	L090/095	401/561 inch-Lbs.	20.06
0439518	68514411486	L099/100	792/1134 inch-Lbs.	47.75
0439543	68514411717	L110	2268 inch-Lbs.	57.78
0439561	68514411993	L150	3708 inch-Lbs.	69.42
0439576	68514412265	L190	4680 inch-Lbs.	81.86

Jaw In-Shear Coupling Inserts (Spiders) and Rings

- New design saves time and maintenance costs
- Allows insert to be replaced without moving either hub
- Use one ring plus one insert in place of standard spider
- Blue urethane insert material has a shore hardness of 50D and a maximum temperature rating of 200°F
- Retaining ring is made from #347 cast stainless steel
- **Use one insert and one ring in conjunction with two hubs for complete assembly**



Part No.	Vendor No.	Style	O.D.	Max. Torque	Price /Ea
0439495	68514471706	L090/095	2.11	670	Insert \$31.85
0439496	68514471679	L090/095	2.11		Ring 26.58
0439521	68514471707	L099/100	2.54	1110	Insert 39.88
0439522	68514471680	L099/100	2.54		Ring 33.25
0439546	68514471708	L110	3.32	2180	Insert 51.16
0439547	68514471681	L110	3.32		Ring 45.15
0439564	68514471709	L150	3.75	3620	Insert 75.74
0439563	68514471682	L150	3.75		Ring 67.22

Flexible Universal Joint (D-Type)

- Industry standard
- Pin & Block design
- Boot retaining grooves standard
- Industrial universal joint product line is well established and provides you with a wide range of standard and specialized products
- The shape of the yoke is a special feature which results in exceptionally high strength, yet allows full, free movement of the joint - which accounts for the high horsepower capacity at high speeds



Flexible Universal Joints

Part No.	Vendor No.	Size	Type	Bore Size	O.D.	Breaking Strength	Price /Ea
0439585	68514415744	D-4	Solid	—	3/4"	768 inch-Lbs.	\$48.96
0439587	68514415809	D-6	Solid	—	1"	1560 inch-Lbs.	67.73
0439589	68514415866	D-8	Solid	—	1-1/4"	5220 inch-Lbs.	89.98
0439598	68514416289	D-4B	Bored	3/8"	3/4"	768 inch-Lbs.	54.54
0439602	68514416363	D-6B	Bored	1/2"	1"	1560 inch-Lbs.	74.97
0439608	68514416431	D-7B	Bored	9/16"	1-1/8"	2880 inch-Lbs.	91.98
0439609	68514416479	D-8B	Bored	5/8"	1-1/4"	5220 inch-Lbs.	99.95

Keystock available on page 15-24.

COUPLINGS & ACCESS. & POWDER METAL BEARINGS

Power Transmission Couplings and Accessories Cont.

Power Drive



S-Flex Coupling Flanges

- Easy to Install and maintenance free
- No Lubrication
- Dampens Vibration and Controls Shock
- Torsionally Soft
- Double Engagement
- The simple design of the S-Flex coupling ensures ease of assembly and reliable performance.
- No special tools are needed for installation or removal. S-Flex couplings can be used in a wide variety of applications
- **Use 2 coupling flanges in conjunction with JE or H insert for a complete assembly**

Part No.	Vendor No.	Size	Style	Bore Size	Description	Material	Price /Ea
0439665	68514436047	3J	J	1/2"	1/8 x 1/16	Zinc Alloy	\$7.38
0439666	68514436048	3J	J	5/8"	3/16 x 3/32	Zinc Alloy	7.38
0439674	68514436052	4J	J	5/8"	3/16 x 3/32	Zinc Alloy	9.35
0439675	68514436053	4J	J	3/4"	3/16 x 3/32	Zinc Alloy	9.35
0439686	68514436059	5J	J	3/4"	3/16 x 3/32	Cast Iron	14.76
0439689	68514436060	5J	J	7/8"	3/16 x 3/32	Cast Iron	14.76
0439684	68514436062	5J	J	1"	1/4 x 1/8	Cast Iron	14.76
0439715	68514436097	6S	S	1"	1/4 x 1/8	Cast Iron	25.59
0439716	68514436099	6S	S	1-1/8"	1/4 x 1/8	Cast Iron	25.59
0439735	68514436126	7S	S	1-3/8"	5/16 x 5/32	Cast Iron	29.52
0439738	68514436129	7S	S	1-5/8"	3/8 x 3/16	Cast Iron	29.52
0439755	68514436142	8S	S	1-1/2"	3/8 x 3/16	Cast Iron	39.37
0439757	68514436145	8S	S	1-3/4"	3/8 x 3/16	Cast Iron	39.37
0439758	68514436146	8S	S	1-7/8"	1/2 x 1/4	Cast Iron	39.37

S-Flex JE Series Inserts

- One piece solid EPDM rubber
- Can be used with "J" or "S" style flanges
- **Use in conjunction with 2 S-Flex coupling flanges for a complete assembly**



Part No.	Vendor No.	Style	Torque	Max. RPM	Price /Ea
0439661	68514436384	3JE	60 inch-Lbs.	9200	\$4.13
0439668	68514435359	4JE	120 inch-Lbs.	7600	5.90
0439678	68514435350	5JE	240 inch-Lbs.	7600	11.81
0439695	68514435569	6JE	450 inch-Lbs.	6000	19.68
0439721	68514435570	7JE	725 inch-Lbs.	5250	25.59
0439740	68514435572	8JE	1135 inch-Lbs.	4500	33.46

S-Flex "H" Series Inserts

- One piece molded Hytrel
- Designed for high torque application
- **Caution:** should only be used with "S" style flanges
- **Use in conjunction with 2 S-Flex coupling flanges for a complete assembly**



Part No.	Vendor No.	Style	Torque	Max. RPM	Price /Ea
0439701	68514440738	6H	1800 inch-Lbs.	6000	\$78.73
0439726	68514436848	7H	2875 inch-Lbs.	5250	114.16
0439746	68514436514	8H	4530 inch-Lbs.	4500	124.00

Powder Metal Bearings



Powder Metal Bronze Flange Bearings

- Superior strength
- Reduced coefficient of friction
- Uniform oil coating of the shaft during operation
- Oil impregnated



Part No.	Vendor No.	ID	OD	Length	Flange OD	Flange Thickness	Price /Each
0435169	SF-610-3	0.1895	0.3140	3/16	7/16	1/16	\$0.35
0435170	SF-610-4	0.1895	0.3140	1/4	7/16	1/16	0.35
0435171	SF-610-5	0.1895	0.3140	5/16	7/16	1/16	0.37
0435174	SF-1216-3	0.2520	0.3770	3/16	15/32	1/16	0.34
0435175	SF-812-4	0.2520	0.3770	1/4	15/32	1/16	0.36
0435176	SF-812-5	0.2520	0.3770	5/16	15/32	1/16	0.39
0435184	SF-1014-6	0.3150	0.4400	3/8	9/16	1/16	0.45
0435191	SF-1216-4	0.3770	0.5020	1/4	5/8	1/16	0.45
0435193	SF-1216-6	0.3770	0.5020	3/8	5/8	1/16	0.52
0435194	SF-1216-8	0.3770	0.5020	1/2	5/8	1/16	0.55
0435195	SF-1216-10	0.3770	0.5020	5/8	5/8	1/16	0.74
0435196	SF-1216-12	0.3770	0.5020	3/4	5/8	1/16	0.78
0435197	SF-1216-16	0.3770	0.5020	1	5/8	1/16	0.84
0435200	SF-1220-8	0.3770	0.6270	1/2	7/8	1/16	0.97
0435204	SF-1418-8	0.4390	0.5650	1/2	11/16	1/16	0.75
0435211	SF-1620-4	0.5020	0.6270	1/4	7/8	1/16	0.58
0435213	SF-1620-8	0.5020	0.6270	1/2	7/8	1/16	0.75
0435215	SF-1620-10	0.5020	0.6270	5/8	7/8	1/16	0.94
0435217	SF-1620-12	0.5020	0.6270	3/4	7/8	1/16	1.05
0435226	SF-1624-8	0.5020	0.7530	1/2	15/16	1/8	1.29
0435227	SF-1624-10	0.5020	0.7530	5/8	15/16	1/8	1.59
0435228	SF-1624-12	0.5020	0.7530	3/4	15/16	1/8	1.75
0435233	SF-2024-10	0.6270	0.7530	5/8	1	3/32	0.97
0435234	SF-2024-12	0.6270	0.7530	3/4	1	3/32	1.15
0435243	SF-2028-10	0.6280	0.8780	5/8	1	1/8	1.62
0435249	SF-2428-8	0.7530	0.8780	1/2	1-1/8	1/8	0.99
0435250	SF-2428-12	0.7530	0.8780	3/4	1-1/8	1/8	1.57
0435258	SF-2432-8	0.7530	1.0030	1/2	1-1/8	1/8	1.72
0435253	SF-2430-12	0.7530	0.9400	3/4	1-1/4	1/8	2.09
0435261	SF-2432-16	0.7530	1.0030	1	1-1/8	1/8	2.35
0435276	SF-3240-12	1.0030	1.2530	3/4	1-5/8	1/8	3.17
0435277	SF-3240-16	1.0030	1.2530	1	1-5/8	1/8	3.91
0435278	SF-3240-20	1.0030	1.2530	1-1/4	1-5/8	1/8	4.65
0435290	SF-4048-8	1.2520	1.5030	1/2	1-11/16	1/8	2.59
0435293	SF-4048-20	1.2520	1.5030	1-1/4	1-11/16	1/8	4.90

Over 150 additional flange bearing sizes available from inventory

Powder Metal Bearings Cont.



Powder Metal Bronze Sleeve Bearings

- Superior strength
- Reduced coefficient of friction
- Uniform oil coating of the shaft during operation
- Oil impregnated

Part No.	Vendor No.	ID	OD	LG	Price /Each
0434593	SS-46-4	0.1270	0.1895	1/4	\$0.29
0434602	SS-68-4	0.1890	0.2520	1/4	0.29
0434607	SS-610-4	0.1900	0.3145	1/4	0.31
0434610	SS-610-10	0.1900	0.3145	5/8	0.46
0434620	SS-810-12	0.2520	0.3150	3/4	0.62
0434621	SS-812-4	0.2520	0.3770	1/4	0.31
0434622	SS-812-6	0.2520	0.3770	3/8	0.40
0434624	SS-812-10	0.2520	0.3770	5/8	0.52
0434629	SS-814-6	0.2520	0.4390	3/8	0.47
0434639	SS-1012-4	0.3145	0.3780	1/4	0.39
0434646	SS-1014-4	0.3145	0.4400	1/4	0.36
0434648	SS-1014-8	0.3145	0.4400	1/2	0.47
0434655	SS-1016-6	0.3145	0.5030	3/8	0.47
0434657	SS-1016-10	0.3145	0.5030	5/8	0.71
0434663	SS-1214-8	0.3770	0.4400	1/2	0.46
0434667	SS-1216-4	0.3780	0.5030	1/4	0.37
0434668	SS-1216-6	0.3780	0.5030	3/8	0.44
0434669	SS-1216-8	0.3780	0.5030	1/2	0.52
0434670	SS-1216-10	0.3780	0.5030	5/8	0.55
0434671	SS-1216-12	0.3780	0.5030	3/4	0.64
0434673	SS-1216-16	0.3780	0.5030	1	0.82
0434675	SS-1216-20	0.3780	0.5030	1-1/4	1.07
0434678	SS-1218-10	0.3780	0.5650	5/8	1.06
0434683	SS-1220-6	0.3780	0.6280	3/8	0.64
0434688	SS-1220-16	0.3780	0.6280	1	1.54
0434692	SS-1224-8	0.3780	0.7530	1/2	1.34
0434696	SS-1418-6	0.4400	0.5650	3/8	0.53
0434697	SS-1418-8	0.4400	0.5650	1/2	0.61
0434704	SS-1420-8	0.4400	0.6280	1/2	0.84
0434714	SS-1620-6	0.5020	0.6280	3/8	0.50
0434715	SS-1620-8	0.5020	0.6280	1/2	0.58
0434716	SS-1620-10	0.5020	0.6280	5/8	0.69
0434717	SS-1620-12	0.5020	0.6280	3/4	0.82
0434719	SS-1620-16	0.5020	0.6280	1	0.96
0434720	SS-1620-18	0.5020	0.6280	1-1/8	1.11
0434725	SS-1622-12	0.5030	0.6900	3/4	1.13
0434734	SS-1624-12	0.5030	0.7530	3/4	1.45
0434737	SS-1624-18	0.5030	0.7530	1-1/8	1.99
0434746	SS-1628-8	0.5030	0.8780	1/2	1.59
0434754	SS-1632-16	0.5030	1.0040	1	4.04
0434760	SS-1822-20	0.5650	0.6900	1-1/4	1.46
0434763	SS-1824-12	0.5650	0.7530	3/4	1.23
0434772	SS-2024-8	0.6280	0.7530	1/2	0.68
0434774	SS-2024-12	0.6280	0.7530	3/4	0.90
0434776	SS-2024-16	0.6280	0.7530	1	1.08
0434782	SS-2026-12	0.6280	0.8150	3/4	1.40
0434788	SS-2028-8	0.6280	0.8780	1/2	1.24
0434792	SS-2028-16	0.6280	0.8780	1	2.11
0434807	SS-2032-24	0.6280	1.0030	1-1/2	5.00
0434810	SS-2228-12	0.6900	0.8780	3/4	1.35
0434816	SS-2428-8	0.7530	0.8780	1/2	0.73
0434817	SS-2428-10	0.7530	0.8780	5/8	0.94
0434818	SS-2428-12	0.7530	0.8780	3/4	1.04
0434829	SS-2430-16	0.7530	0.9410	1	1.87
0434837	SS-2432-8	0.7530	1.0030	1/2	1.39
0434838	SS-2432-10	0.7530	1.0030	5/8	1.69
0434839	SS-2432-12	0.7530	1.0030	3/4	1.69
0434841	SS-2432-16	0.7530	1.0030	1	2.21
0434844	SS-2432-24	0.7530	1.0030	1-1/2	3.43
0434849	SS-2436-12	0.7530	1.1280	3/4	3.20
0434858	SS-2440-24	0.7530	1.2530	1-1/2	7.65
0434868	SS-2832-12	0.8780	1.0030	3/4	1.30
0434878	SS-2836-16	0.8780	1.1280	1	2.71

Powder Metal Bronze Sleeve Bearings Cont.

Part No.	Vendor No.	ID	OD	LG	Price /Each
0434889	SS-2840-16	0.8780	1.2530	1	\$4.29
0434905	SS-3236-16	1.0040	1.1280	1	1.90
0434911	SS-3238-16	1.0040	1.1900	1	2.89
0434919	SS-3240-16	1.0040	1.2540	1	3.05
0434936	SS-3244-16	1.0040	1.3790	1	4.74
0434954	SS-3640-20	1.1290	1.2540	1-1/4	2.53
0434961	SS-3644-12	1.1290	1.3790	3/4	3.17
0434970	SS-3648-20	1.1290	1.5040	1-1/4	6.34
0434991	SS-4048-16	1.2540	1.5040	1	3.65
0434995	SS-4048-24	1.2540	1.5040	1-1/2	5.26
0435008	SS-4052-24	1.2540	1.6290	1-1/2	8.19
0435013	SS-4056-24	1.2540	1.7540	1-1/2	12.00
0435029	SS-4452-24	1.3790	1.6290	1-1/2	5.85
0435033	SS-4456-16	1.3790	1.7540	1	6.95
0435039	SS-4652-24	1.4420	1.6290	1-1/2	4.69
0435054	SS-4856-24	1.5040	1.7540	1-1/2	6.28
0435059	SS-4856-48	1.5040	1.7540	3	12.95
0435065	SS-4860-24	1.5040	1.8790	1-1/2	10.44
0435072	SS-4864-32	1.5040	2.0040	2	18.22
0435081	SS-5260-40	1.6290	1.8790	2-1/2	12.65
0435093	SS-5664-16	1.7540	2.0040	1	5.15
0435101	SS-5668-24	1.7540	2.1290	1-1/2	13.22
0435110	SS-6472-24	2.0040	2.2540	1-1/2	8.85
0435119	SS-6476-48	2.0040	2.3800	3	27.34
0435124	SS-6480-32	2.0040	2.5050	2	23.82
0435129	SS-7284-32	2.2540	2.6300	2	21.25
0435137	SS-8088-32	2.5040	2.7540	2	14.00
0435144	SS-8096-32	2.5040	3.0050	2	29.33
0435150	SS-88104-48	2.7540	3.2550	3	46.54
0435154	SS-96104-48	3.0050	3.2550	3	25.62
0435155	SS-96112-32	3.0050	3.5050	2	34.33
0435163	SS-128144-64	4.0035	4.5040	4	89.20
0435166	SS-144168-80	4.5040	5.2545	5	204.00
0435168	SS-160184-32	5.0040	5.7550	2	85.98

Over 600 additional sleeve bushing sizes available from inventory

Powder Metal Bronze Thrust Bearings

- Superior strength
- Reduced coefficient of friction
- Uniform oil coating on both surfaces during operation
- Oil impregnated



Part No.	Vendor No.	ID	OD	Thickness	Price /Each
0435460	ST-816-2	0.2550	0.5000	1/16	\$0.27
0435461	ST-820-2	0.2550	0.6250	1/16	0.35
0435462	ST-1020-2	0.3150	0.6250	1/16	0.30
0435464	ST-1220-2	0.3850	0.6250	1/16	0.37
0435466	ST-1224-2	0.3800	0.7500	1/16	0.37
0435470	ST-1624-2	0.5050	0.7500	1/16	0.34
0435472	ST-1632-2	0.5100	1.0000	1/16	0.51
0435473	ST-1632-3	0.5100	1.0000	3/32	0.58
0435474	ST-1632-4	0.5100	1.0000	1/8	0.72
0435478	ST-2032-4	0.6280	1.0000	1/8	0.64
0435483	ST-2040-4	0.6280	1.2500	1/8	1.01
0435486	ST-2440-2	0.7530	1.2500	1/16	0.60
0435488	ST-2444-2	0.7530	1.3750	1/16	0.68
0435491	ST-2450-3	0.7650	1.5625	3/32	1.34
0435494	ST-2848-4	0.8905	1.5000	1/8	1.35
0435498	ST-3248-4	1.0030	1.5000	1/8	1.17
0435504	ST-3256-4	1.0120	1.7500	1/8	1.92
0435505	ST-3264-4	1.0160	2.0000	1/8	2.29
0435513	ST-4064-4	1.2650	2.0000	1/8	2.06
0435520	ST-4880-4	1.5050	2.5050	1/8	3.19
0435525	ST-6284-4	1.9530	2.6250	1/8	2.98
0435528	ST-6496-8	2.0110	3.0000	1/4	7.35

Power Drive

RADIAL BALL BEARINGS

Radial Ball Bearings



For All Radial Ball Bearings:

Excellent for radial load applications
30-40% grease-filled. 5200 Chrome Steel.

Available in rubber seal (2RS) or metal shield (ZZ). The most common fit for our bearings is C3. Meets ABEC 1-9, AFBMA and ISO Standards.

Popular usages include: automotive, wheels, electric motors, tools, appliances, transmissions and generators.

Note: Vendor part numbers ending in "2RS" use rubber seals. Vendor part numbers ending in "ZZ" use metal shields.

Code to Diagrams:

d=I.D. D=O.D. W=Width

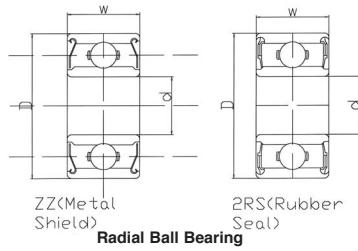

Radial Ball Bearing

1600 Series - Inch



Part No.	Vendor No.	I.D.	O.D.	Width	Static Load	Dynamic Load	Price /Each
0474436	1601-2RS	.1875	0.6875	0.3125	163	340	\$1.99
0474437	1601-ZZ	.1875	0.6875	0.3125	163	340	1.92
0474438	1602-2RS	.2500	0.6875	0.3125	163	340	1.99
0474439	1602-ZZ	.2500	0.6875	0.3125	163	340	1.92
0474440	1603-2RS	.3125	0.875	0.3438	302	573	1.99
0474441	1603-ZZ	.3125	0.875	0.3438	302	573	1.92
0474442	1604-2RS	.3750	0.875	0.3438	302	573	1.99
0474443	1604-ZZ	.3750	0.875	0.3438	302	573	1.92
0474444	1605-2RS	.3125	0.9063	0.3125	302	573	1.99
0474445	1605-ZZ	.3125	0.9063	0.3125	302	573	1.92
0474446	1606-2RS	.3750	0.9063	0.3125	302	573	2.15
0474447	1606-ZZ	.3750	0.9063	0.3125	302	573	2.10
0474448	1607-2RS	.4375	0.9063	0.3125	436	800	2.15
0474449	1607-ZZ	.4375	0.9063	0.3125	436	800	2.10
0474450	1614-2RS	.3750	1.125	0.375	505	882	2.25
0474451	1614-ZZ	.3750	1.125	0.375	505	882	2.19
0474452	1615-2RS	.4375	1.125	0.375	505	882	2.32
0474453	1615-ZZ	.4375	1.125	0.375	505	882	2.26
0474454	1616-2RS	.5000	1.125	0.375	505	882	2.32
0474455	1616-ZZ	.5000	1.125	0.375	505	882	2.26
0474456	1620-2RS	.4375	1.375	0.4375	781	1323	2.63
0474457	1620-ZZ	.4375	1.375	0.4375	781	1323	2.58
0474458	1621-2RS	.5000	1.375	0.4375	781	1323	2.71
0474459	1621-ZZ	.5000	1.375	0.4375	781	1323	2.66
0474460	1622-2RS	.5625	1.375	0.4375	781	1323	2.85
0474461	1622-ZZ	.5625	1.375	0.4375	781	1323	2.80
0474462	1623-2RS	.6250	1.375	0.4375	781	1323	2.85
0474463	1623-ZZ	.6250	1.625	0.4375	781	1323	3.00
0474464	1628-2RS	.6250	1.625	0.5	1001	1627	3.55
0474465	1628-ZZ	.6250	1.625	0.5	1001	1627	3.50
0474466	1630-2RS	.7500	1.625	0.5	1001	1627	3.55
0474467	1630-ZZ	.7500	1.625	0.5	1001	1627	3.50
0474468	1633-2RS	.6250	1.75	0.5	1001	1627	3.89
0474469	1633-ZZ	.6250	1.75	0.5	1001	1627	3.84
0474470	1635-2RS	.7500	1.75	0.5	1001	1627	3.89
0474471	1635-ZZ	.7500	1.75	0.5	1001	1627	3.84
0474472	1638-2RS	.75	2	0.5625	1563	2426	4.50
0474473	1638-ZZ	.75	2	0.5625	1563	2426	3.97
0474474	1640-2RS	.875	2	0.5625	1563	2426	3.99
0474475	1640-ZZ	.875	2	0.5625	1563	2426	3.97
0474476	1641-2RS	1.0	2	0.5625	1563	2426	3.94
0474477	1641-ZZ	1.0	2	0.5625	1563	2426	3.89
0474478	1652-2RS	1.1250	2.5	0.625	1890	2880	5.63
0474479	1652-ZZ	1.1250	2.5	0.625	1890	2880	5.58
0474480	1654-2RS	1.25	2.5	0.625	1890	2880	5.85
0474481	1654-ZZ	1.25	2.5	0.625	1890	2880	5.80

Note: Sizes are in inches.

10-152

HYDRAULICS, PNEUMATICS & POWER TRANSMISSION

R-Series - Inch

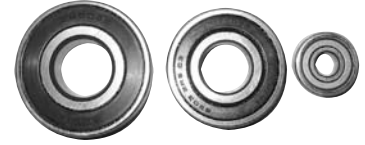

Part No.	Vendor No.	I.D.	O.D.	Width	Static Load	Dynamic Load	Price /Each
0474484	R2-2RS	0.125	0.375	0.1562	29	73	\$1.85
0474485	R2-ZZ	0.125	0.375	0.1562	29	73	1.59
0474486	R3-2RS	.1875	0.5	0.196	64	147	1.69
0474487	R3-ZZ	.1875	0.5	0.196	64	147	1.64
0474488	R4-2RS	.25	0.625	0.196	77	167	1.54
0474489	R4-ZZ	.25	0.625	0.196	77	167	1.49
0474490	R4-A-2RS	.25	0.75	0.2812	198	403	1.64
0474491	R4-A-ZZ	.25	0.75	0.2812	198	403	1.59
0474492	R6-2RS	.3750	0.875	0.2812	304	575	1.64
0474493	R6-ZZ	.3750	0.875	0.2812	304	575	1.59
0474494	R8-2RS	.5	1.125	0.3125	505	880	1.98
0474495	R8-ZZ	.5	1.125	0.3125	505	880	1.86
0474496	R10-2RS	.625	1.375	0.3438	624	1036	2.49
0474497	R10-ZZ	.625	1.375	0.3438	624	1036	2.37
0474498	R12-2RS	.75	1.625	0.4375	1000	1630	5.65
0474499	R12-ZZ	.75	1.625	0.4375	1000	1630	2.94
0474500	R14-2RS	.875	1.875	0.5	1111	1740	3.73
0474501	R14-ZZ	.875	1.875	0.5	1111	1740	3.56
0474502	R16-2RS	1.0	2	0.5	1222	1850	4.63
0474503	R16-ZZ	1.0	2	0.5	1222	1850	4.45
0474504	R18-2RS	1.125	2.125	0.5	1407	2150	5.58
0474505	R18-ZZ	1.125	2.125	0.5	1407	2150	5.35
0474506	R20-2RS	1.25	2.25	0.5	1960	2420	5.91
0474507	R20-ZZ	1.25	2.25	0.5	1960	2420	5.58
0474508	R24-2RS	1.5	2.625	0.5625	2085	2906	9.35
0474509	R24-ZZ	1.5	2.625	0.5625	2085	2906	8.64

Note: Sizes are in inches.

6000 Extra Light Series - Metric



Part No.	Vendor No.	I.D.	O.D.	Width	Static Load	Dynamic Load	RPM	Price /Each
0474371	6000-2RS	10	26	8	440	1040	34000	\$1.37
0474372	6000-ZZ	10	26	8	440	1040	34000	1.26
0474373	6001-2RS	12	28	8	540	1140	32000	2.10
0474374	6001-ZZ	12	28	8	540	1140	32000	1.37
0474375	6002-2RS	15	32	9	640	1260	28000	1.69
0474376	6002-ZZ	15	32	9	640	1260	28000	1.67
0474377	6003-2RS	17	35	10	735	1360	24000	2.15
0474378	6003-ZZ	17	35	10	735	1360	24000	1.99
0474379	6004-2RS	20	42	12	1140	2110	20000	2.54
0474380	6004-ZZ	20	42	12	1140	2110	20000	2.49
0474381	6005-2RS	25	47	12	1315	2520	18000	3.38
0474382	6005-ZZ	25	47	12	1315	2520	18000	3.65

Note: Sizes are in millimeters.

RADIAL BALL BEARINGS & TAPERED ROLLER BEARINGS

Radial Ball Bearings Cont.



6200 Light Series - Metric



Part No.	Vendor No.	I.D.	O.D.	Width	Static Load	Dynamic Load	RPM	Price /Each
0474383	6200-2RS	10	30	9	540	1140	30000	\$1.54
0474384	6200-ZZ	10	30	9	540	1140	30000	1.43
0474385	6201-2RS	12	32	10	690	1550	28000	1.64
0474386	6201-ZZ	12	32	10	690	1550	28000	1.59
0474387	6202-2RS	15	35	11	850	1760	24000	1.71
0474388	6202-ZZ	15	35	11	850	1760	24000	1.64
0474389	6203-2RS	17	40	12	1080	2150	20000	1.86
0474390	6203-ZZ	17	40	12	1080	2150	20000	1.81
0474391	6204-2RS	20	47	14	1500	2860	18000	2.73
0474392	6204-ZZ	20	47	14	1500	2860	18000	2.63
0474393	6205-2RS	25	52	15	1770	3150	15000	3.34
0474394	6205-ZZ	25	52	15	1770	3150	15000	3.45
0474395	6206-2RS	30	62	16	2540	4390	13000	4.44
0474396	6206-ZZ	30	62	16	2540	4390	13000	3.89
0474397	6207-2RS	35	72	17	3470	5740	11000	5.98
0474398	6207-ZZ	35	72	17	3470	5740	11000	5.25
0474399	6208-2RS	40	80	18	4000	6910	10000	6.97
0474400	6208-ZZ	40	80	18	4000	6910	10000	7.75
0474401	6209-2RS	45	85	19	4570	7470	9000	9.25
0474402	6209-ZZ	45	85	19	4570	7470	9000	8.90
0474403	6210-2RS	50	90	20	5240	7900	8500	11.99
0474404	6210-ZZ	50	90	20	5240	7900	8500	11.20
0474405	6211-2RS	55	100	21	6600	9810	7500	13.85
0474406	6211-ZZ	55	100	21	6600	9810	7500	13.23
0474407	6212-2RS	60	110	22	8140	10700	7000	17.34
0474408	6212-ZZ	60	110	22	8140	10700	7000	16.10

Note: Sizes are in millimeters.

6300 Medium Series - Metric

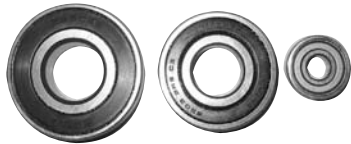

Part No.	Vendor No.	I.D.	O.D.	Width	Static Load	Dynamic Load	RPM	Price /Each
0474412	6300-2RS	10	35	11	780	1810	26000	\$2.10
0474413	6300-ZZ	10	35	11	780	1810	26000	1.99
0474414	6301-2RS	12	37	12	950	2190	24000	2.32
0474415	6301-ZZ	12	37	12	950	2190	24000	2.26
0474416	6302-2RS	15	42	13	1250	2570	20000	2.89
0474417	6302-ZZ	15	42	13	1250	2570	20000	2.82
0474418	6303-2RS	17	47	14	1500	3040	19000	3.72
0474419	6303-ZZ	17	47	14	1500	3040	19000	3.67
0474420	6304-2RS	20	52	15	1760	3580	16000	4.49
0474421	6304-ZZ	20	52	15	1760	3580	16000	4.44
0474422	6305-2RS	25	62	17	2540	5060	14000	5.03
0474423	6305-ZZ	25	62	17	2540	5060	14000	4.81
0474424	6306-2RS	30	72	19	3380	6320	11000	7.98
0474425	6306-ZZ	30	72	19	3380	6320	11000	7.83
0474426	6307-2RS	35	80	21	4400	7470	10000	9.23
0474427	6307-ZZ	35	80	21	4400	7470	10000	8.99
0474428	6308-2RS	40	90	23	5400	9230	9000	12.10
0474429	6308-ZZ	40	90	23	5400	9230	9000	11.72
0474430	6309-2RS	45	100	25	6600	11900	8000	13.85
0474431	6309-ZZ	45	100	25	6600	11900	8000	13.62
0474432	6310-2RS	50	110	27	8600	13900	7500	18.41
0474433	6310-ZZ	50	110	27	8600	13900	7500	18.24
0474434	6311-2RS	55	120	29	10120	16100	6700	19.97
0474435	6311-ZZ	55	120	29	10120	16100	6700	19.81

Note: Sizes are in millimeters.

Miscellaneous Radial Ball Bearings

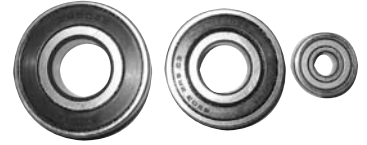

Part No.	Vendor No.	I.D.	O.D.	Width	Static Load	Dynamic Load	Price /Each
0474409	Z9504B	0.7505"	1.7803"	0.6098"	-	-	\$3.99
0474410	99502H	0.62499"	1.3749"	0.433"	446	756	1.98
0474411	499502H	0.62499"	1.3749"	0.433"	446	756	2.14
0474510	608-ZZ	8.0mm	22mm	7mm	290	580	0.99
0474511	608-2RS	8.0mm	22mm	7mm	290	580	0.99

Tapered Roller Bearings



For All Tapered Roller Bearings:

Ideal to support combination of radial and thrust loads - limited to low and moderate speeds. Excellent for combined axial and radial loads.

52100 chrome steel. Popular usages include: hubs, conveyors, pumps, automobiles, propeller shafts, heavy-duty equipment and wheels.

Code to Diagrams:

d=Cone I.D. (Inside race with rollers) D=Cup O.D. (Steel ring with tapered raceway) B=Cone Width C=Cup Width T=Overall Width r=I.D. Radius

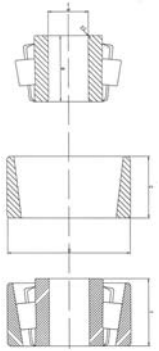

Tapered Roller Bearing

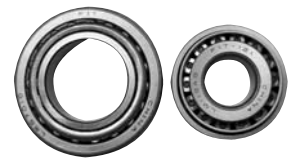

Part No.	Vendor No.	Cone I.D.	Cone Width	I.D. Radius	Cup O.D.	Cup Width	Overall Width	Price /Each
0474513	572	-	-	-	5.5115	1.125	-	\$10.36
0474520	39520	-	-	-	4.4375	0.9375	-	7.95
0474522	HM212011	-	-	-	4.8125	1.17	-	8.39
0474523	HM212047	2.5	1.51	0.28	-	-	-	18.17
0474524	HM212049	2.625	1.51	0.14	-	-	-	17.89
0474525	HM218210	-	-	-	5.7864	1.2795	-	13.26
0474526	HM218248	3.5423	1.5748	0.28	-	-	-	28.44
0474529	SET-1 LM11749/10	.6875	0.575	0.05	1.57	0.42	0.545	4.71
0474530	SET-2 LM11949/10	.750	0.655	0.05	1.781	0.475	0.61	4.32
0474532	SET-4 L44649/10	1.0625	0.58	0.14	1.98	0.42	0.56	4.97
0474533	SET-5 LM48548/10	1.3750	0.72	-	2.5625	0.55	0.71	6.93
0474534	SET-6 LM67048/10	1.25	0.66	-	2.328	0.465	0.625	5.58
0474537	SET-14 L44643/10	1.000	0.58	0.05	1.98	0.42	0.56	4.98
0474540	SET-17 L68149/11	1.3775	0.66	-	2.3612	0.47	0.625	5.63
0474544	SET-35 LM501349/10	1.625	0.78	0.14	2.891	0.58	0.77	9.46
0474545	SET-36 LM603049/12	1.7812	0.7812	0.14	3.0625	0.6562	0.8437	9.69
0474547	SET-38 LM104949/11	2	0.875	0.14	3.25	0.65	0.8313	12.50

Note: Sizes are in inches.

MOUNTED UNITS

Mounted Units



For All Mounted Units:

Grease fitting - grease groove and three grease holes located along outer ring of bearing allow relubrication.

Housing - one piece high tensile strength cast iron housings on standard units.

Deep groove - races and large balls for higher load carrying capacity.

Xtra-Loc - set screws with special knurled ends for better shaft holding power.

Self-aligning surface - allows bearing to align on a displaced shaft without distorting seals.

Code to Diagrams:

d=Shaft Size h=Shaft Height e=Bolt Hole Center a=Overall Length
w=Overall Height (Pillow Block Only) Z=Overall Height (Four and Two Bolt Flange Only)

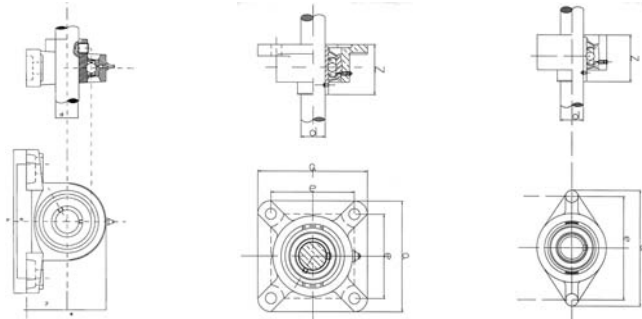

Pillow Block

Four Bolt Flange

Two Bolt Flange

Pillow Block

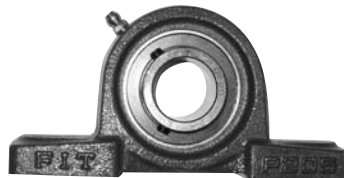

Part No.	Vendor No.	Shaft Size	Shaft Height	Bolt Hole Center	Bolt Size	Overall Lgth.	Overall Ht.	Price /Each
Fractional Sizes								
0474548	204-12 UCP	3/4	1-5/16	3-3/4	3/8	5	2-17/32	\$11.31
0474554	205-16 UCP	1	1-7/16	4-1/8	3/8	5-1/2	2-25/32	12.84
0474560	206-18 UCP	1-1/8	1-11/16	4-3/4	1/2	6-1/2	3-5/16	14.75
0474561	206-19 UCP	1-3/16	1-11/16	4-3/4	1/2	6-1/2	3-5/16	14.75
0474562	206-20 UCP	1-1/4	1-11/16	4-3/4	1/2	6-1/2	3-5/16	14.32
0474572	207-20 UCP	1-1/4	1-7/8	5	1/2	6-37/64	3-21/32	19.36
0474573	207-22 UCP	1/3/8	1-7/8	5	1/2	6-37/64	3-21/32	18.79
0474574	207-23 UCP	1-7/16	1-7/8	5	1/2	6-37/64	3-21/32	18.79
0474584	208-24 UCP	1-1/2	1-15/16	5-13/32	1/2	7-1/4	3-27/32	21.91
0474590	209-26 UCP	1-5/8	2-1/8	5-3/4	1/2	7-15/32	4-3/16	28.25
0474591	209-27 UCP	1-11/16	2-1/8	5-3/4	1/2	7-15/32	4-3/16	27.42
0474592	209-28 UCP	1-3/4	2-1/8	5-3/4	1/2	7-15/32	4-3/16	28.25
0474602	210-30 UCP	1-7/8	2-1/4	6-1/4	5/8	8-1/8	4-7/16	33.47
0474603	210-31 UCP	1-15/16	2-1/4	6-1/4	5/8	8-1/8	4-7/16	32.49
0474611	211-32 UCP	2	2-1/2	6-23/32	5/8	8-5/8	4-59/64	38.90
0474612	211-35 UCP	2-3/16	2-1/2	6-23/32	5/8	8-5/8	4-59/64	39.92
Metric Sizes								
0474549	204-20mm UCP	20mm	33.3mm	95mm	10mm	127mm	64mm	11.65
0474555	205-25mm UCP	25mm	36.5mm	105mm	10mm	140mm	71mm	13.23
0474563	206-30mm UCP	30mm	42.9mm	121mm	14mm	165mm	84mm	14.75
0474575	207-35mm UCP	35mm	47.6mm	127mm	14mm	167mm	93mm	19.36
0474585	208-40mm UCP	40mm	49.2mm	137mm	14mm	184mm	98mm	22.57
0474593	209-45mm UCP	45mm	54.0mm	146mm	14mm	190mm	106mm	28.25
0474604	210-50mm UCP	50mm	57.2mm	159mm	16mm	206mm	113mm	33.47

Additional fractional and Metric sizes are available. Please ask your Fastenal Representative for details.

Four Bolt Flange



Part No.	Vendor No.	Shaft Size	Bolt Hole Center	Bolt Size	Overall Lgth.	Overall Ht.	Price /Each
Fractional Sizes							
0474550	204-12 UCF	3/4	2-33/64	3/8	3-3/8	1-5/16	11.35
0474556	205-16 UCF	1	2-3/4	3/8	3-3/4	1-13/32	12.84
0474564	206-18 UCF	1-1/8	3-17/64	3/8	4-1/4	1-19/32	14.75
0474565	206-19 UCF	1-3/16	3-17/64	3/8	4-1/4	1-19/32	14.75
0474566	206-20 UCF	1-1/4	3-17/64	3/8	4-1/4	1-19/32	14.32
0474576	207-20 UCF	1-1/4	3-5/8	7/16	4-19/32	1-3/4	19.36
0474577	207-22 UCF	1-3/8	3-5/8	7/16	4-19/32	1-3/4	18.79
0474578	207-23 UCF	1-7/16	3-5/8	7/16	4-19/32	1-3/4	18.79
0474586	208-24 UCF	1-1/2	4-1/64	1/2	5-1/8	2-1/32	21.91
0474594	209-26 UCF	1-5/8	4-9/64	1/2	5-13/32	2-1/16	28.25
0474595	209-27 UCF	1-11/16	4-9/64	1/2	5-13/32	2-1/16	27.42
0474596	209-28 UCF	1-3/4	4-9/64	1/2	5-13/32	2-1/16	28.25
0474605	210-30 UCF	1-7/8	4-3/8	1/2	5-5/8	2-5/32	33.47
0474606	210-31 UCF	1-15/16	4-3/8	1/2	5-5/8	2-5/32	32.49
0474614	211-32 UCF	2	5-1/8	5/8	6-3/8	2-5/16	38.98
0474615	211-35 UCF	2-3/16	5-1/8	5/8	6-3/8	2-5/16	39.97
Metric Sizes							
0474551	204-20mm UCF	20mm	64mm	10mm	86mm	33.3mm	11.65
0474557	205-25mm UCF	25mm	70mm	10mm	95mm	35.7mm	13.23
0474567	206-30mm UCF	30mm	83mm	10mm	108mm	40.2mm	14.75
0474579	207-35mm UCF	35mm	92mm	12mm	117mm	44.4mm	19.36
0474587	208-40mm UCF	40mm	102mm	14mm	130mm	51.2mm	22.57
0474597	209-45mm UCF	45mm	105mm	14mm	137mm	52.2mm	28.25
0474607	210-50mm UCF	50mm	111mm	14mm	143mm	54.6mm	33.47

Additional fractional and Metric sizes are available. Please ask your Fastenal Representative for details.

Two Bolt Flange



Part No.	Vendor No.	Shaft Size	Bolt Hole Center	Bolt Size	Overall Lgth.	Overall Ht.	Price /Each
Fractional Sizes							
0474552	204-12 UCFL	3/4	3-35/64	3/8	4-7/16	1-5/16	\$11.35
0474558	205-16 UCFL	1	3-57/64	1/2	5-1/8	1-13/32	12.84
0474568	206-18 UCFL	1-1/8	4-39/64	1/2	5-13/16	1-19/32	14.75
0474569	206-19 UCFL	1-3/16	4-39/64	1/2	5-13/16	1-19/32	14.75
0474570	206-20 UCFL	1-1/4	4-39/64	1/2	5-13/16	1-19/32	14.32
0474580	207-20 UCFL	1-1/4	5-1/8	1/2	6-11/32	1-3/4	19.36
0474581	207-22 UCFL	1-3/8	5-1/8	1/2	6-11/32	1-3/4	18.79
0474582	207-23 UCFL	1-7/16	5-1/8	1/2	6-11/32	1-3/4	18.79
0474588	208-24 UCFL	1-1/2	5-43/64	1/2	6-7/8	2-1/32	21.91
0474598	209-26 UCFL	1-5/8	5-53/64	5/8	7-13/32	2-1/16	28.25
0474599	209-27 UCFL	1-11/16	5-53/64	5/8	7-13/32	2-1/16	27.42
0474600	209-28 UCFL	1-3/4	5-53/64	5/8	7-13/32	2-1/16	28.25
0474609	210-31 UCFL	1-15/16	6-3/16	5/8	7-3/4	2-5/32	32.49
0474617	211-32 UCFL	2	7-1/4	5/8	8-13/16	2-5/16	38.98
Metric Sizes							
0474553	204-20mm UCFL	20mm	90mm	10mm	113mm	33.3mm	11.65
0474559	205-25mm UCFL	25mm	99mm	14mm	130mm	35.7mm	13.23
0474571	206-30mm UCFL	30mm	117mm	14mm	148mm	40.2mm	14.75
0474589	208-40mm UCFL	40mm	144mm	14mm	175mm	51.2mm	22.57

Additional fractional and Metric sizes are available. Please ask your Fastenal Representative for details.

Pullers and Puller Sets



General Purpose Pullers

The POSI LOCK line of quality manual gear and bearing pullers sets new standards for quickness, ease and convenience, making it a one-man operation. The T-handle and Cage® control the jaws at all times. This means the opening, closing, locking and aligning of the jaws is all done automatically by simply turning the

T-handle. Cage® design pullers provide superior locking power. The no-slip feature saves wear and tear on components removed. POSI LOCK's unique design allows completion of the following applications eliminating the need for many specialty pullers:

- Alternator pulley removal
- Battery terminal removal
- Harmonic balancer pulley removal
- Transmission and differential yoke removal
- Steering wheel removal
- Power-steering pulley removal
- Pitman arm removal
- Timing gear and sprocket removal
- Differential side bearing removal
- Steering arm and linkage removal
- U-joint removal and installation
- Removal of failed ball bearings by clamping in the ball groove of bearing race
- Removal of tapered roller bearing by clamping on lip of race
- Pinion bearing removal
- Brake drum removal
- Transmission bearing removal



Three Jaw Pullers

Model No.	Part No.	Description	Spread	Reach	Price /Each
102	0204022	1Ton	1/4"-3"-1/4"	2-1/4"	\$94.99
103	0204023	2Ton	1/4"-4"-1/2"	3"	109.99
104	0204024	5 Ton	1/2"-5"	4"	166.79
106	0204025	10 Ton	1/2"-7"	6"	217.99
108	0204026	17 Ton	3/4"-12"	8"	269.79
110	0204027	20 Ton	1"-15"	10"	299.99

Two Jaw Pullers

Part No.	Model No.	Description	Spread	Reach	Price /Each
0204032	204	2 Ton	1/2"-5"	4"	\$142.49
0204033	206	6Ton	1/2"-7"	6"	189.99
0204035	210	14 Ton	1"-15"	10"	246.99
0204037	216	35 Ton	3"-25"	14"	632.49

Puller Sets

Part No.	Description	Vendor No.	Price /ea
0401858	4 Puller Set: Models 104, 106, 110, & 206 with tips	PM4	\$816.99
0401859	5 Puller Set: Models 103, 104, 106, 110, & 206 with tips	PM5	917.29

Internal Slide Hammer Puller Set

Ideal for the removal of many tough internal pulling jobs such as crankshaft pilot bearings, bearing cups, needle bearings, bushings, seals and grease retainers. Tool board and accessories included. Weight: 15 lbs. Create an external slide hammer puller by coupling the POSI LOCK Model 104 or 204 with the slide rod and 2.5 lb hammer or 5 lb hammer.

The PM16 Internal Slide Hammer Puller set is ideal for the removal of many tough internal pulling jobs such as crankshaft pilot bearings, bearing cups, needle bearings, bushings, seals and grease retainers.

- 3 Jaw Internal Puller-Reach 3", Spread 9/16" to 4"
- Slide Rod-Length 24"
- 2.5 lb Hammer
- Set of 3 Long Jaws-Reach 13", Spread 1" to 5-1/4"
- Tool Board and Accessories



Part No.	Price /Each
0204039	\$369.89

Hub Puller Adaptor Set

- Model HP-2 makes removal of fans, blower wheels and bearings simple
- Unique collar design allows this to be a general purpose puller on the following equipment: condensers, convection ovens, chillers, ice machines, freezers, furnace fans, exhaust and ventilating fans, auto heaters, defroster and air conditioning fans
- 4 square head set screws provide superior locking power
- Pull hubs from 0 to 2" in diameter
- Tip reducer/extender included for small diameter



Part No.	Price /Each
0204038	\$235.50

POWER TEAM®

Gear Pullers Grip-O-Matic®

Comes in the following capacity ranges: 1 to 37 ton mechanical and 5 to 100 ton hydraulic. Available in 2-way, 3-way or 2/3-way combinations.

1 TON CAPACITY Standard Jaw Puller, 3 Jaw

Part No.	Model No.	Reach	Spread	Screw Size	Weight	Price /Each
0489651	1021	2.12" Max.	3.25" Max.	5/16" - 24 x 3-7/8" lg.	5 lbs.	\$54.55



2 TON CAPACITY Reversible Jaw Puller, 2/3 Jaw (with double-end, reversible jaws)

Part No.	Model No.	Reach	Spread	Screw Size	Weight	Price /Each
0489652	1023	3.38" Max.	4.75" Max.	3/8" - 24 x 4-7/8" lg.	1.3 lbs.	\$49.25



5 TON CAPACITY Reversible Jaw Puller, 2/3 Jaw (with double-end, reversible jaws)

Part No.	Model No.	Reach	Spread	Screw Size	Weight	Price /Each
0489653	1026	3.25" Max.	7.00" Max.	9/16" - 20 x 6-15/16" lg.	2.8 lbs.	\$71.50



5 TON CAPACITY LONG REACH Reversible Jaw Puller, 2/3 Jaw (with double-end, reversible jaws)

Part No.	Model No.	Reach	Spread	Screw Size	Weight	Price /Each
0489654	1027	5.50" Max.	7.00" Max.	9/16" - 20 x 6-15/16" lg.	3.3 lbs.	\$71.50



Hydraulic Gear Pullers Grip-O-Matic

Get the world's most copied puller design; the harder the pulling force, the tighter the jaws grip for secure holding force tested for top performance and reliability at maximum capacity and jaw spread removing a wide variety of gears, bearings, bushings, pulleys and other press-fitted parts becomes a routine task



Part No.	Vendor No.	Capacity	Description	Price /Each
0489645	PH63C	6 tons	2/3 way	\$555.75
0489646	PH83C	8 tons	2/3 way	668.55
0489647	PH113C	15 tons	2/3 way	765.50

ROLLER CHAIN AND LINKS/CHAIN & BELT TENSIONERS

Roller Chain and Links



Power Drive

Offset Links

Offset links (also known as 1/2 links or crank links) are used to make a chain an odd number of pitches in length. Most commonly they are used to shorten a chain by one pitch.

Size	Drives Inc. Domestic		Fastenal Quality Import	
	Part No.	Price /Each	Part No.	Price /Each
#25	0495952	\$3.70	60202	\$0.81
#35	0495953	2.99	60205	0.81
#40	0495954	4.55	60208	0.93
#41	0495955	6.25	60211	0.93
#50	0495956	4.75	60214	1.32
#60	0495957	5.78	60217	1.49
#80	0495958	10.81	60220	2.49
#100	0495959	16.49	60223	4.87
#120	0495960	22.75	60226	8.20
#140	0495961	27.95	60229	12.28
#160	0495962	33.91	60232	12.20
#200	0495963	88.78	60235	37.89

Connecting Links



Size	Drives Inc. Domestic		Fastenal Quality Import	
	Part No.	Price /Each	Part No.	Price /Each
#25	0495964	\$1.11	60201	\$0.43
#35	0495965	1.25	60204	0.50
#40	0495966	1.33	60207	0.56
#41	0495967	0.90	60210	0.50
#50	0495968	1.56	60213	0.75
#60	0495969	2.40	60216	0.87
#80	0495970	3.95	60219	1.62
#100	0495971	6.26	60222	3.66
#120	0495972	9.13	60225	4.89
#140	0495973	14.21	60228	6.45
#160	0495974	17.55	60231	9.71
#200	0495975	46.78	60234	19.10

Roller Chain Single Strand - Riveted

Comes in 10' sections.



Size	Drives Inc. Domestic		Fastenal Quality Import	
	Part No.	Price /Each	Part No.	Price /Foot
#25	0495940	\$8.91	60200	\$2.17
#35	0495941	6.15	60203	1.93
#40	0495942	7.28	60206	1.87
#41	0495943	5.99	60209	1.39
#50	0495944	8.11	60212	2.86
#60	0495945	10.99	60215	3.64
#80	0495946	23.55	60218	6.31
#100	0495947	35.28	60221	12.65
#120	0495948	54.30	60224	19.42
#140	0495949	65.80	60227	26.19
#160	0495950	78.85	60230	30.93
#200	0495951	180.73	60233	64.09



Snapidle® Roller Chain Tensioners

- Minimal wear to the chain drive since the chain rides on the side plates
- Requires no mounting devices or maintenance and is a benefit to the drive system, not a deterrent. Economical, easy to install, maintenance free, the Snapidle® is the answer to the problem of controlling drive chains.
- Since the Snapidle® "floats" on the chain drive and actually absorbs shock, it does not add to vibration in the drive. Both sprockets will have the maximum chain wrap possible, thereby increasing chain life (load sharing) and sprocket life (the chain is unable to crawl out of the teeth).

Part No.	Use With	Price /Ea
0400329	ANSI #25	\$40.00
0400330	ANSI #35	42.50
0400331	ANSI #25-2, 41, 40, 52	55.00
0400332	ANSI #35-2, 50	65.00
0400333	ANSI #40-2, 35-3, 60	85.00
0400334	ANSI #50-2, 35-4, 80	102.50
0400335	ANSI #60-2, 40-3, 76, 100	145.00
0400336	ANSI #80-2, 50-3, 40-4, 120	170.00

Note: Chain not included.



Rosta Roller Chain and Belt Tensioners

Lovejoy ROSTA offers a complete line of multi-purpose elastomeric tensioners that can solve most types of tensioning, suspension, and vibration absorption problems in all fields of mechanical engineering.



- Easy to Install and maintenance free
- No Lubrication
- Self-adjusting convenience.
- Protective finish for long life.
- Customized solutions to tensioning, damping, supporting or mounting problems
- Will tension roller chains, v-belts, or flat belts
- Increase chain and belt life by as much as 30%

Part No.	Vendor No.	Size	Price /Ea
0439801	68514417451	SE11	\$57.36
0439802	68514417452	SE15	63.32
0439803	68514417453	SE18	76.35
0439804	68514417454	SE27	97.77
0439805	68514417455	SE38	167.60
0439806	68514417456	SE45	316.58

Tensioner Selection Table¹ (S=Single Strand; D=Double Strand; T=Triple Strand)

ANSI Chain Size	V-Belt ² Size Range	Flat Belt Width	Tensioner Size
25S	A	-	SE11
35 S, D, T	A, B, 3L	-	SE15
35 S, D, T, 40 S, D, T	B, C, 4L, 5L	1", 2"	SE18
41 S, D, T			
40 T	D, E	2", 3", 4"	SE27
41 T			
50 S, D, T			
60 S, D, T			
80 S, D, T	-	4", 5"	SE38
80 T	-	5", 6"	SE45
100 S, D, T			
120 S, D, T			
140 S, D, T			
160 S, D, T			
180 S, D			
200 S, D			

1. This data is based on use at "normal" position for all types except SE-W.

2. Precise sizing for V-Belt applications is dependent on variables such as belt size, pulley diameter, HP/RPM, etc. and should be done with the help of Lovejoy Application Engineering.

Drive Belts

BANDO

Duraflex GL®-FHP

Light industrial applications, appliances, and power equipment require the same tough, long wearing, trouble free belts as high horsepower drives. Because Duraflex GL® has the same construction features as Power King® heavy duty belts, you get maximum belt life on short center distance, high speed fractional horsepower drives.



3L Type

Part No.	Belt Number	Length	Price
0453559	3L170	17"	\$4.34
0453560	3L180	18"	4.69
0453561	3L190	19"	4.69
0453562	3L200	20"	4.69
0453563	3L210	21"	4.69
0453564	3L220	22"	4.34
0453565	3L230	23"	4.69
0453566	3L240	24"	4.69
0453567	3L250	25"	4.34
0453568	3L260	26"	4.69
0453569	3L270	27"	4.58
0453570	3L280	28"	4.69
0453571	3L290	29"	4.81
0453572	3L300	30"	5.04
0453573	3L310	31"	5.04
0453574	3L320	32"	5.11
0453575	3L330	33"	5.17
0453576	3L340	34"	5.36
0453578	3L360	36"	5.64
0453579	3L370	37"	5.41
0453590	3L480	48"	6.00
0453591	3L490	49"	6.05
0453593	3L510	51"	6.12
0453595	3L530	53"	6.23
0453601	3L600	59"	6.60

4L Type

Part No.	Belt Number	Length	Price
0453606	4L170	17"	\$4.45
0453607	4L180	18"	4.45
0453608	4L190	19"	4.45
0453609	4L200	20"	4.45
0453610	4L210	21"	4.45
0453611	4L220	22"	4.45
0453612	4L230	23"	4.45
0453613	4L240	24"	4.45
0453614	4L250	25"	4.45
0453615	4L260	26"	4.52
0453616	4L270	27"	4.58
0453617	4L280	28"	4.58
0453618	4L290	29"	4.64
0453619	4L300	30"	4.69
0453620	4L310	31"	4.75
0453621	4L320	32"	4.81
0453622	4L330	33"	4.87
0453623	4L340	34"	4.93
0453624	4L350	35"	4.99
0453625	4L360	36"	5.04
0453626	4L370	37"	5.11
0453627	4L380	38"	5.17
0453628	4L390	39"	5.50
0453629	4L400	40"	5.28
0453630	4L410	41"	5.35
0453631	4L420	42"	5.58
0453632	4L430	43"	5.70
0453633	4L440	44"	5.77
0453634	4L450	45"	6.19
0453635	4L460	46"	5.87
0453636	4L470	47"	6.00
0453637	4L480	48"	6.00
0453638	4L490	49"	6.05
0453639	4L500	50"	6.18
0453640	4L510	51"	6.23
0453641	4L520	52"	6.29
0453642	4L530	53"	6.41
0453643	4L550	55"	6.47
0453644	4L560	56"	6.65
0453645	4L570	57"	6.65
0453646	4L580	58"	6.76
0453648	4L600	61"	6.95
0453649	4L610	61"	7.01
0453650	4L620	62"	7.06
0453652	4L640	64"	7.25
0453656	4L680	68"	7.53
0453658	4L700	70"	7.66

5L Type

Part No.	Belt Number	Length	Price
0453663	5L290	29"	\$7.42
0453664	5L300	30"	5.77
0453666	5L320	32"	5.87
0453673	5L390	39"	9.64
0453675	5L410	41"	10.11
0453676	5L420	42"	7.71
0453677	5L430	43"	10.53
0453679	5L450	45"	10.92
0453680	5L460	46"	8.49
0453682	5L480	48"	11.63
0453683	5L490	49"	11.82
0453684	5L500	50"	12.11
0453685	5L510	51"	9.14
0453688	5L540	54"	9.61
0453691	5L570	57"	13.62
0453692	5L580	58"	13.83

Power King V-Belt

Because they are still the most practical, economical, and dependable belts for industrial drives, innovations have failed to displace the need for the classical belts. Bando's constant improvements in materials, design, and manufacturing methods help Power King® keep pace with industry's ever increasing demands for long, trouble-free belt service.



Power Drive

A Type (1/2" Top Width by 5/16" Thick)

Part No.	Belt Number	Length	Price
0453096	A21	23	\$3.78
0453097	A22	24	3.78
0453098	A23	25	3.78
0453099	A24	26	3.91
0453100	A25	27	4.10
0453101	A26	28	4.10
0453102	A27	29	4.15
0453103	A28	30	4.22
0453104	A29	31	4.29
0453105	A30	32	4.34
0453106	A31	33	4.45
0453107	A32	34	4.34
0453108	A33	35	4.71
0453109	A34	36	4.81
0453110	A35	37	4.93
0453111	A36	38	4.85
0453112	A37	39	5.29
0453113	A38	40	5.21
0453114	A39	41	5.63
0453115	A40	42	5.61
0453116	A41	43	6.12
0453117	A42	44	6.02
0453118	A43	45	6.61
0453119	A44	46	6.51
0453120	A45	47	6.73
0453121	A46	48	6.73
0453122	A47	49	7.11
0453123	A48	50	6.81
0453124	A49	51	7.25
0453125	A50	52	7.30
0453126	A51	53	7.35
0453127	A52	54	7.35
0453128	A53	55	7.47
0453129	A54	56	7.53
0453130	A55	57	7.53
0453131	A56	58	7.59
0453132	A57	59	7.65
0453133	A58	60	7.72
0453134	A59	61	7.77
0453135	A60	62	7.82
0453136	A61	63	7.88
0453137	A62	64	7.95
0453138	A63	65	8.02
0453139	A64	66	8.07
0453140	A65	67	8.12
0453141	A66	68	8.19
0453142	A67	69	8.24
0453143	A68	70	8.24
0453145	A70	72	8.48
0453146	A71	73	8.48
0453147	A72	74	8.53
0453148	A73	75	8.60
0453150	A75	77	8.84
0453153	A78	80	9.18
0453159	A84	86	10.15
0453160	A85	87	10.32

DRIVE BELTS

Drive Belts Cont.

BANDO

Power King V-Belt Cont.

Part No.	Belt Number	Length	Price
0453162	A87	89	\$10.56
0453163	A88	90	10.66
0453164	A89	91	10.80
0453165	A90	92	10.97
0453166	A91	93	11.09
0453168	A93	95	11.31
0453169	A94	96	11.46
0453170	A95	97	11.55
0453171	A96	98	11.67
0453177	A105	107	12.50
0453179	A112	114	13.70
0453182	A120	122	14.99



B Type (21/32" Top Width by 13/32" Thick)

Part No.	Belt Number	Length	Price
0453189	B27	30	\$7.31
0453190	B28	31	7.31
0453193	B31	34	7.59
0453194	B32	35	7.59
0453195	B33	36	7.72
0453196	B34	37	7.72
0453197	B35	38	7.82
0453198	B36	39	7.95
0453199	B37	40	8.49
0453200	B38	41	8.49
0453201	B39	42	8.59
0453202	B40	43	8.73
0453203	B41	44	8.73
0453204	B42	45	8.82
0453205	B43	46	8.96
0453206	B44	47	9.06
0453207	B45	48	9.20
0453208	B46	49	9.31
0453209	B47	50	9.43
0453210	B48	51	9.56
0453211	B49	52	9.65
0453212	B50	53	9.79
0453213	B51	54	9.91
0453214	B52	55	10.03
0453215	B53	56	10.03
0453216	B54	57	10.14
0453217	B55	58	9.75
0453218	B56	59	9.75
0453219	B57	60	10.39
0453220	B58	61	10.49
0453221	B59	62	10.61
0453222	B60	63	10.22
0453223	B61	64	10.84
0453224	B62	65	10.44
0453225	B63	66	11.08
0453226	B64	67	11.22
0453227	B65	68	11.31
0453228	B66	69	11.46
0453229	B67	70	11.55
0453230	B68	71	11.12
0453231	B69	72	11.82
0453232	B70	73	11.91
0453233	B71	74	12.05
0453234	B72	75	12.16
0453235	B73	76	12.32
0453236	B74	77	12.51
0453237	B75	78	12.09
0453239	B77	80	13.04
0453240	B78	81	13.22

B Type (21/32" Top Width by 13/32" Thick)

Part No.	Belt Number	Length	Price
0453241	B79	82	\$13.39
0453242	B80	83	13.58
0453243	B81	84	13.75
0453244	B82	85	13.91
0453245	B83	86	14.13
0453247	B85	88	13.76
0453248	B86	89	14.65
0453249	B87	90	14.81
0453250	B88	91	14.99
0453252	B90	93	14.61
0453253	B91	94	15.52
0453254	B92	95	15.71
0453255	B93	96	15.87
0453257	B95	98	16.23
0453258	B96	99	16.43
0453259	B97	100	16.59
0453260	B98	101	16.78
0453261	B99	102	16.94
0453262	B100	103	17.12
0453264	B103	106	17.66
0453266	B105	108	17.66
0453268	B108	111	18.96
0453269	B110	113	18.83
0453270	B111	114	18.83
0453271	B112	115	18.83
0453277	B120	123	19.97
0453278	B122	125	20.32
0453279	B123	126	20.52
0453280	B124	127	20.67
0453281	B126	129	21.04
0453282	B128	131	21.37
0453285	B133	136	23.12
0453286	B136	139	23.44
0453287	B138	141	24.87
0453288	B140	143	24.87
0453290	B144	147	24.87
0453293	B150	153	26.07
0453294	B154	157	26.35
0453298	B173	176	28.72
0453299	B180	183	30.20
0453302	B195	198	32.59
0453305	B225	226	37.91
0453307	B255	256	42.65
0453310	B300	301	52.13



D Type (1-1/4" Top Width by 3/4" Thick)

Part No.	Belt Number	Length	Price
0453376	D144	149	\$83.21
0453377	D158	163	91.20
0453385	D270	272	152.84
0453386	D285	287	161.15
0453389	D360	362	203.18

Power King® V-Belts



C Type (7/8" Top width by 17/32" Thick)

Part No.	Belt Number	Length	Price
0453315	C60	64	\$19.14
0453320	C72	76	22.52
0453321	C75	79	23.09
0453325	C81	85	25.47
0453326	C83	87	26.30
0453327	C85	89	26.30
0453328	C90	94	28.42
0453330	C96	100	30.02
0453333	C99	103	31.08
0453334	C100	104	31.39
0453337	C105	109	32.89
0453338	C108	112	33.76
0453339	C109	113	34.06
0453340	C112	116	34.97
0453342	C115	119	36.12
0453343	C120	124	37.63
0453344	C124	128	38.51
0453346	C128	132	39.86
0453348	C132	136	42.06
0453349	C136	140	42.06
0453355	C158	162	48.86
0453357	C173	177	53.61
0453360	C195	199	60.41
0453361	C210	214	65.14
0453368	C315	317	96.53

Power King® Cog V-Belts

These high horsepower energy savers feature a molded cog design. When the proven reliability, economy, and efficiency of conventional V-belts are combined with an innovative molded cog design, belt users reap important benefits!



AX Type (1/2" Top Width by 5/16" Thick)

Part No.	Belt Number	Length	Price
0453392	AX24	26	\$6.18
0453394	AX26	28	10.65
0453397	AX29	31	6.65
0453398	AX31	33	6.33
0453399	AX32	34	6.96
0453400	AX33	35	12.51
0453401	AX34	36	6.72
0453402	AX35	37	12.90
0453403	AX36	38	12.57
0453404	AX37	39	7.52
0453405	AX38	40	13.82
0453407	AX42	44	7.83
0453408	AX43	45	15.11
0453410	AX46	48	14.80
0453411	AX48	50	8.31
0453413	AX51	53	8.57
0453414	AX53	55	16.74
0453415	AX54	56	9.31
0453417	AX56	58	9.55
0453418	AX58	60	9.90
0453419	AX60	62	9.42
0453421	AX64	66	10.37
0453425	AX71	73	11.44
0453426	AX75	77	11.72
0453431	AX96	98	15.46

Drive Belts Cont.

BANDO

BX Type (21/32" Top Width by 7/16" Thick)

Part No.	Belt Number	Length	Price
0453436	BX35	38	\$9.42
0453438	BX38	41	9.81
0453439	BX41	44	11.31
0453440	BX42	45	10.78
0453441	BX44	47	12.25
0453442	BX46	49	11.67
0453443	BX48	51	23.02
0453444	BX50	53	22.57
0453445	BX51	54	24.06
0453446	BX52	55	13.28
0453447	BX53	56	13.39
0453448	BX54	57	13.53
0453449	BX55	58	13.62
0453450	BX56	59	25.14
0453451	BX57	60	13.98
0453452	BX59	62	13.98
0453453	BX60	63	24.56
0453454	BX61	64	14.28
0453455	BX62	65	13.69
0453456	BX63	66	14.64
0453457	BX64	67	14.80
0453458	BX65	68	15.00
0453459	BX66	69	15.17
0453461	BX68	71	14.79
0453462	BX70	73	29.30
0453463	BX71	74	29.72
0453464	BX75	78	16.02
0453465	BX77	80	17.31
0453466	BX78	81	17.54
0453467	BX79	82	17.72
0453468	BX80	83	18.02
0453469	BX81	84	18.31
0453470	BX82	85	18.68
0453471	BX83	86	18.84
0453472	BX85	88	19.15
0453473	BX90	93	37.28
0453474	BX93	96	21.03
0453475	BX95	98	21.46
0453476	BX96	99	21.74
0453477	BX97	100	21.97
0453479	BX100	103	22.38
0453480	BX103	106	22.94
0453481	BX105	108	23.35
0453482	BX112	115	25.23
0453483	BX113	116	25.48
0453484	BX115	118	25.95
0453486	BX120	123	26.65
0453487	BX124	127	27.55
0453488	BX128	131	28.50
0453490	BX136	139	30.40

CX Type (7/8" Top Width by 17/32" Thick)

Part No.	Belt Number	Length	Price
0453493	CX90	94	\$37.85
0453499	CX120	124	49.81
0453500	CX128	132	53.06

Power Ace® Narrow V-Belts

Power Ace®, a "narrow" profile belt that transfers loads very efficiently and therefore delivers higher horsepower ratings than classical section belts, should be considered for any new drive system. Power Ace's® efficient design, executed with premium quality materials and advanced manufacturing techniques, can transmit up to 3 times the horsepower of classical section belts in the same space—or the same horsepower in 1/2 to 2/3 the space. You save belt and sheave weight, space and cost—making Power Ace® a great value.



3V Type

Part No.	Belt Number	Length	Price
0453014	3V315	31.5	\$6.76
0453016	3V355	35.5	7.25
0453017	3V375	37.5	8.08
0453018	3V400	40	7.51
0453019	3V425	42.5	8.90
0453020	3V450	45	8.49
0453021	3V475	47.5	8.78
0453022	3V500	50	10.32
0453023	3V530	53	9.78
0453024	3V560	56	9.48
0453025	3V600	60	10.16
0453026	3V630	63	9.83
0453027	3V670	67	10.29
0453028	3V710	71	13.16
0453029	3V750	75	12.77
0453030	3V800	80	12.93
0453031	3V850	85	13.71
0453033	3V950	95	15.60
0453034	3V1000	100	16.48
0453035	3V1060	106	17.41

5V Type (21/32" Top x 17/32" Thick)

Part No.	Belt Number	Length	Price
0453043	5V600	60	\$22.34
0453045	5V670	67	24.88
0453046	5V710	71	26.43
0453047	5V750	75	27.97
0453048	5V800	80	29.80
0453049	5V850	85	32.17
0453051	5V950	95	35.84
0453052	5V1000	100	35.99
0453053	5V1060	106	40.16
0453056	5V1250	125	50.00
0453058	5V1400	140	50.56
0453059	5V1500	150	53.66
0453061	5V1700	170	64.56
0453062	5V1800	180	65.26
0453063	5V1900	190	72.56
0453065	5V2120	212	77.44

8V Type

Part No.	Belt Number	Length	Price
0453076	8V1180	118	\$85.40
0453077	8V1250	125	90.56
0453081	8V1600	160	116.05
0453082	8V1700	170	124.48
0453085	8V2000	200	146.35
0453088	8V2360	236	172.31

Power Ace® Cog V-Belts



3VX

5VX

3VX Type

Part No.	Length	Belt Number	Price
0453502	25	3VX250	\$5.93
0453504	28	3VX280	6.23
0453505	30	3VX300	6.35
0453506	31.5	3VX315	14.15
0453507	33.5	3VX335	6.76
0453508	35.5	3VX355	7.06
0453509	37.5	3VX375	7.30
0453510	40	3VX400	16.37
0453511	42.5	3VX425	16.99
0453512	45	3VX450	17.71
0453513	47.5	3VX475	18.27
0453514	50	3VX500	8.37
0453533	50	5VX500	18.55
0453515	53	3VX530	18.28
0453516	56	3VX560	8.30
0453517	60	3VX600	9.32
0453518	63	3VX630	9.60
0453519	67	3VX670	21.36
0453520	71	3VX710	11.57
0453521	75	3VX750	23.78
0453522	80	3VX800	11.90
0453523	85	3VX850	28.56
0453543	90	5VX900	63.17
0453525	95	3VX950	15.29
0453526	100	3VX1000	16.12
0453527	106	3VX1060	17.07
0453547	112	5VX1120	40.70
0453529	118	3VX1180	19.73
0453530	125	3VX1250	21.10
0453531	132	3VX1320	21.15

5VX Type

Part No.	Length	Belt Number	Price
0453535	56	5VX560	\$20.22
0453536	60	5VX600	21.87
0453537	63	5VX630	46.57
0453538	67	5VX670	49.51
0453539	71	5VX710	23.65
0453540	75	5VX750	55.65
0453541	80	5VX800	56.52
0453542	85	5VX850	60.79
0453544	95	5VX950	33.41
0453545	100	5VX1000	34.30
0453546	106	5VX1060	79.54
0453548	118	5VX1180	88.73
0453549	125	5VX1250	94.29
0453550	132	5VX1320	99.44
0453552	150	5VX1500	112.72
0453553	170	5VX1700	128.00

DRIVE BELTS & O-RINGS

Drive Belts Cont.

BANDO

Rib Ace V-Belts



Part No.	Belt No.	Size	Price
0454135	6PK2440	.84 x 96.5	\$24.75
0454136	6PK2425	.84 x 96.0	22.50
0454137	6PK1765	.84 x 70.0	18.64
0454138	6PK2490	.84 x 98.5	26.50
0454139	6PK2600	.84 x 103.0	27.60
0454140	6PK2515	.84 x 99.625	24.02
0454141	6PK1800	.84 x 71.5	19.60
0454142	6PK2220	.84 x 88.0	23.20
0454143	6PK2465	.84 x 97.5	25.48
0454144	7PK2470	.98 x 97.7	28.29
0454145	7PK2480	.98 x 97.8	28.42
0454146	6PK2345	.84 x 93.0	24.24

Part No.	Vendor No.	Size	Price
0454147	6PK2590	.84 x 102.5	\$27.56
0454148	6PL2565	.84 x 101.5	24.48
0454149	6PK2210	.84 x 87.5	23.07
0454150	6PK2400	.84 x 95.0	23.20
0454151	6PK2455	.84 x 97.0	25.37
0454152	6PK2240	.84 x 89.0	22.92
0454153	6PK1790	.84 x 71.0	19.28
0454154	6PK2160	.84 x 85.5	24.42
0454155	6PK2120	.84 x 96.5	20.24
0454156	6PK2275	.84 x 90.0	23.66
0454157	6PK2375	.84 x 94.0	24.55
0454158	6PK2225	.84 x 88.25	25.15
0454159	6PK2615	.84 x 103.5	27.71

Variable Speed Belts



Variable speed drives demand a unique combination of belt features. Because these belts are wide in proportion to their thickness, they must have extreme crosswise rigidity. Without it, the belt will dish in, throw the tensile cords out of alignment, and affect speed control. Variable speed belts also require lengthwise flexibility to bend around small sheaves without excess strain that will shorten belt life. Bando's cog design solves these potential problems by providing excellent flexibility, without sacrificing the crosswise rigidity required to properly position the tensile cords. The result is precise speed control, a wide range of speed ratios, and long, dependable service.

Part No.	Belt Number	Price
0453705	1922V426	\$53.31
0453708	1922V484	58.34
0453711	1922V604	62.49
0453715	2322V347	68.53
0453718	2322V441	72.20
0453724	2830V363	66.47
0453725	2830V367	67.35
0453729	2926V666	101.63
0453732	3432V450	140.20
0453734	4230V556	200.55
0453739	4430V850	248.27

O-Rings



In addition to the sizes listed below, all AS568A sizes of Buna-N 70 Durometer

O-Rings are available, as well as all AS568A sizes of Buna-N 90, Fluorocarbon 75, Fluorocarbon 90, Silicone 70, EPDM 70, Neoprene 70, and TFE.

Also available is a wide selection of metric sizes in both Buna-N 70 and Fluorocarbon 75 Durometer.

Buna-N 70 O-Rings

- Recommended for general applications
- 70 durometer
- Black in color

Buna-N 70 1/16" Cross Section

Trade Size	I.D.	O.D.	Small Pack			Standard Pack		
			Part No.	Pkg. Qty.	Price /Pkg.	Part No.	Pkg. Qty.	Price /Pkg.
#006	1/8	1/4	1166800	50	\$1.50	66800	100	\$2.48
#007	5/32	9/32	1166801	50	1.50	66801	100	2.63
#008	3/16	5/16	1166802	50	1.50	66802	100	2.58
#009	7/32	11/32	1166803	50	1.50	66803	100	2.63
#010	1/4	3/8	1166804	50	1.50	66804	100	2.68
#011	5/16	7/16	1166805	50	1.50	66805	100	2.74
#012	3/8	1/2	1166806	50	1.50	66806	100	2.80
#013	7/16	9/16	1166807	50	1.50	66807	100	2.65
#014	1/2	5/8	1166808	50	1.50	66808	100	2.75
#015	9/16	11/16	1166809	50	1.50	66809	100	2.75
#016	5/8	3/4	1166810	25	1.25	66810	100	3.65
#017	11/16	13/16	1166811	25	1.25	66811	100	4.18
#018	3/4	7/8	1166812	25	1.50	66812	100	4.60
#019	13/16	15/16	1166813	25	1.50	66813	100	5.00
#020	7/8	1	1166814	25	1.50	66814	100	5.15
#021	15/16	1-1/16	1166815	25	1.50	66815	100	5.57
#022	1	1-1/8	1166816	20	1.30	66816	100	5.98
#023	1-1/16	1-3/16	1166817	20	1.40	66817	100	6.39
#024	1-1/8	1-1/4	1166818	20	1.60	66818	100	7.08
#025	1-3/16	1-5/16	1166819	15	1.35	66819	100	7.72
#026	1-1/4	1-3/8	1166820	15	1.50	66820	100	8.37
#027	1-5/16	1-7/16	1166821	15	1.50	66821	100	8.86
#028	1-3/8	1-1/2	110480800	10	1.40	0480800	100	4.20
#029	1-1/2	1-5/8	110480801	10	1.40	0480801	100	11.37
#030	1-5/8	1-3/4	110480802	10	1.50	0480802	100	11.90
#031	1-3/4	1-7/8				0480803	100	12.19
#032	1-7/8	2	110480804	10	1.50	0480804	100	12.38

Buna-N 70 3/32" Cross Section

Trade Size	I.D.	O.D.	Small Pack			Standard Pack		
			Part No.	Pkg. Qty.	Price /Pkg.	Part No.	Pkg. Qty.	Price /Pkg.
#110	3/8	9/16	1166822	40	\$1.40	66822	100	\$3.00
#111	7/16	5/8	1166823	40	1.60	66823	100	3.43
#112	1/2	11/16	1166824	40	1.60	66824	100	3.74
#113	9/16	3/4	1166825	40	1.60	66825	100	3.95
#114	5/8	13/16	1166826	25	1.38	66826	100	4.17
#115	11/16	7/8	1166827	25	1.38	66827	100	4.12
#116	3/4	15/16	1166828	25	1.38	66828	100	4.33
#117	13/16	1	1166829	25	1.50	66829	100	4.72
#118	7/8	1-1/16	1166830	25	1.50	66830	100	4.94
#119	15/16	1-1/8	1166831	25	1.50	66831	100	5.26
#120	1	1-3/16	1166832	25	1.50	66832	100	5.36
#121	1-1/16	1-1/4	1166833	20	1.20	66833	100	5.90
#122	1-1/8	1-5/15	1166834	20	1.40	66834	100	6.43
#123	1-3/16	1-3/8	1166835	20	1.40	66835	100	6.97
#124	1-1/4	1-7/16	1166836	20	1.60	66836	100	7.58
#125	1-5/16	1-1/2	1166837	15	1.35	66837	100	8.04
#126	1-3/8	1-9/16	1166838	15	1.35	66838	100	8.64
#127	1-7/16	1-5/8	1166839	15	1.50	66839	100	9.06
#128	1-1/2	1-11/16	1166840	15	1.50	66840	100	9.59
#129	1-9/16	1-3/4	1166841	10	1.10	66841	100	10.13
#130	1-5/8	1-13/16	1166842	10	1.20	66842	100	10.67
#131	1-11/16	1-7/8				0480805	100	13.32
#132	1-3/4	1-15/16				0480806	100	14.47
#133	1-13/16	2				0480807	100	15.54
#134	1-7/8	2-1/16				0480808	100	16.61
#135	1-15/16	2-1/8				0480809	100	17.68
#136	2	2-3/16				0480810	100	19.91
#137	2-1/16	2-1/4	1166843	10	1.70	66843	100	19.90
#138	2-1/8	2-5/16				0480811	100	21.96
#139	2-3/16	2-3/8	1166844	10	1.80	66844	100	22.30
#141	2-5/16	2-1/2				0480812	100	12.40
#142	2-3/8	2-9/16				0480813	100	13.10
#145	2-9/16	2-3/4				0480814	100	15.60
#148	2-3/4	2-15/16				66845	100	16.10
#153	3-1/2	3-11/16				0480815	100	20.70
#157	4-1/2	4-11/16				0480816	100	35.50
#158	4-3/4	4-15/16				0480817	100	36.20
#159	5	5-3/16				0480818	100	38.90
#162	5-3/4	5-7/16				0480819	100	42.10

O-Rings Cont.



Buna-N 70 1/8" Cross Section

Trade Size	I.D.	O.D.	Small Pack			Standard Pack		
			Part No.	Pkg. Qty.	Price /Pkg.	Part No.	Pkg. Qty.	Price /Pkg.
#202	1/4	1/2				66846	100	\$3.92
#210	3/4	1	1166847	20	\$1.20	66847	100	5.00
#211	13/16	1-1/16	1166848	20	1.50	66848	100	6.60
#212	7/8	1-1/8	1166849	20	1.60	66849	100	7.30
#213	15/16	1-3/16	1166850	20	1.80	66850	100	8.57
#214	1	1-1/4	1166851	15	1.50	66851	100	9.73
#215	1-1/16	1-5/16	1166852	15	1.65	66852	100	10.72
#216	1-1/8	1-3/8	1166853	15	1.80	66853	100	11.79
#217	1-3/16	1-7/16	1166854	10	1.40	66854	100	12.86
#218	1-1/4	1-1/2	1166855	10	1.50	66855	100	13.86
#219	1-5/16	1-9/16	1166856	10	1.60	66856	100	14.92
#220	1-3/8	1-5/8	1166857	10	1.70	66857	100	16.07
#221	1-7/16	1-11/16	1166858	10	1.90	66858	100	17.14
#222	1-1/2	1-3/4	1166859	10	2.00	66859	100	18.22
#223	1-5/8	1-7/8	1166860	10	2.10	66860	100	19.29
#224	1-3/4	2	1166861	5	1.10	66861	100	20.36
#225	1-7/8	2-1/8	1166862	5	1.15	66862	100	20.60
#226	2	2-1/4	1166863	5	1.30	66863	100	23.50
#227	2-1/8	2-3/8				0480820	100	25.71
#228	2-1/4	2-1/2	1166864	5	1.50	66864	100	27.86
#229	2-3/8	2-5/8				0480821	100	31.16
#230	2-1/2	2-3/4	1166865	5	1.70	66865	100	32.14
#231	2-5/8	2-7/8	110480822	5	1.90	0480822	100	34.28
#232	2-3/4	3	1166866	5	2.05	66866	100	35.20
#233	2-7/8	3-1/8				0480823	100	36.50
#234	3	3-1/4	1166867	3	1.35	66867	100	36.60
#235	3-1/8	3-3/8				66868	100	36.90
#236	3-1/4	3-1/2	1166869	3	1.59	66869	100	38.70
#237	3-3/8	3-5/8				0480824	50	20.60
#238	3-1/2	3-3/4				66870	50	21.25
#239	3-5/8	3-7/8				66871	50	21.45
#240	3-3/4	4				0480825	50	21.65
#242	4	4-1/4				0480826	50	22.75
#244	4-1/4	4-1/2				0480827	50	25.50
#245	4-3/8	4-5/8				0480828	50	26.15
#246	4-1/2	4-3/4				0480829	50	26.40
#248	4-3/4	5	110480830	2	1.64	0480830	50	26.70
#252	5-1/4	5-1/2				0480831	50	27.75
#259	6-1/4	6-1/2				0480832	50	28.70
#260	6-1/2	6-3/4				0480833	50	30.25
#264	7-1/2	7-3/4				0480834	50	31.10

Buna-N 70 3/16" Cross Section

Trade Size	I.D.	O.D.	Small Pack			Bulk Pack	
			Part No.	Pkg. Qty.	Price /Pkg.	Part No.	Price /Each
#325	1-1/2	1-7/8	1166886	5	\$1.15	66886	\$0.21
#326	1-5/8	2	1166887	5	1.35	66887	0.25
#327	1-3/4	2-1/8	1166888	5	1.50	66888	0.28
#329	2	2-3/8	1166889	5	1.55	66889	0.29
#330	2-1/8	2-1/2	1166890	5	1.70	66890	0.32
#331	2-1/4	2-5/8	110480835	3	1.32	0480835	0.41
#332	2-3/8	2-3/4	110480836	3	1.38	0480836	0.42
#333	2-1/2	2-7/8	1166891	3	1.41	66891	0.44
#334	2-5/8	3				0480837	0.46
#335	2-3/4	3-1/8				0480838	0.48
#336	2-7/8	3-1/4				66892	0.49
#337	3	3-3/8				0480839	0.51
#338	3-1/8	3-1/2				0480840	0.57
#339	3-1/4	3-5/8				66893	0.58
#340	3-3/8	3-3/4				0480841	0.59
#341	3-1/2	3-7/8				66894	0.64
#342	3-5/8	4				66895	0.70
#344	3-7/8	4-1/4				66896	0.80
#345	4	4-3/8				66897	0.86
#346	4-1/8	4-1/2				66898	0.91
#347	4-1/4	4-5/8				0480842	0.95
#348	4-3/8	4-3/4				0480843	1.03
#350	4-5/8	5				0480844	1.05

Buna-N 70 1/4" Cross Section

Trade Size	I.D.	O.D.	Part No.	Price /Each
#425	4-1/2	5	66899	\$1.14
#426	4-5/8	5-1/8	0480845	1.39
#427	4-3/4	5-1/4	66900	1.43
#428	4-7/8	5-3/8	66901	1.47
#429	5	5-1/2	0480846	1.55
#430	5-1/8	5-5/8	0480847	1.61
#431	5-1/4	5-3/4	0480848	1.70
#432	5-3/8	5-7/8	0480849	1.75
#433	5-1/2	6	66902	1.83
#435	5-3/4	6-1/4	0480850	1.94
#437	6	6-1/2	0480851	2.02
#438	6-1/4	6-3/4	0480852	2.10
#439	6-1/2	7	66903	2.26
#441	7	7-1/2	0480853	2.48
#442	7-1/4	7-3/4	0480854	2.53
#443	7-1/2	8	0480855	2.63
#444	7-3/4	8-1/4	0480856	2.80
#445	8	8-1/2	0480857	2.90

O-Ring Hand Kit Part #99113

- Nitrile 70 Durometer (Buna N)
- 30 Most Popular Sizes
- 382 Total O-Rings
- Convenient storage case for quick size identification



Part No.	Price /Each
99113	\$24.53

Contains the following O-Rings:

Universal Number	Width	Inside Dia.	Outside Dia.	Pkg. Qty.
006	1/16	1/8	1/4	20
007	1/16	5/32	9/32	20
008	1/16	3/16	5/16	20
009	1/16	7/32	11/32	20
010	1/16	1/4	3/8	20
011	1/16	5/16	7/16	20
012	1/16	3/8	1/2	20
110	3/32	3/8	9/16	13
111	3/32	7/16	5/8	13
112	3/32	1/2	11/16	13
113	3/32	9/16	3/4	13
114	3/32	5/8	13/16	13
115	3/32	11/16	7/8	13
116	3/32	3/4	15/16	13
210	1/8	3/4	1	10

Universal Number	Width	Inside Dia.	Outside Dia.	Pkg. Qty.
211	1/8	13/16	1-1/16	10
212	1/8	7/8	1-1/8	10
213	1/8	15/16	1-3/16	10
214	1/8	1	1-1/4	10
215	1/8	1-1/16	1-5/16	10
216	1/8	1-1/8	1-3/8	10
217	1/8	1-3/16	1-7/16	10
218	1/8	1-1/4	1-1/2	10
219	1/8	1-5/16	1-9/16	10
220	1/8	1-3/8	1-5/8	10
221	1/8	1-7/16	1-11/16	10
222	1/8	1-1/2	1-3/4	10
325	3/16	1-1/2	1-7/8	7
326	3/16	1-5/8	2	7
327	3/16	1-3/4	2-1/8	7

O-RINGS

O-Rings Cont.



Power Drive & Miscellaneous

Metric Buna-N 70

Width	Inside Dia.	Outside Dia.	Part No.	Price /Each
1.5mm	5mm	8mm	0480735	\$0.06
1.5mm	6mm	9mm	0480736	0.07
1.5mm	7mm	10mm	0480737	0.07
1.5mm	8mm	11mm	0480738	0.07
1.5mm	9mm	12mm	0480739	0.07
1.5mm	10mm	13mm	0480740	0.08
1.5mm	12mm	15mm	0480741	0.08
1.5mm	14mm	17mm	0480742	0.09
2mm	4mm	8mm	0480743	0.07
2mm	5mm	9mm	0480744	0.07
2mm	6mm	10mm	0480745	0.08
2mm	7mm	11mm	0480746	0.08
2mm	8mm	12mm	0480747	0.08
2mm	9mm	13mm	0480748	0.08
2mm	10mm	14mm	0480749	0.09
2mm	11mm	15mm	0480750	0.09
2mm	12mm	16mm	0480751	0.09
2mm	13mm	17mm	0480752	0.09
2mm	14mm	18mm	0480753	0.09
2mm	15mm	19mm	0480754	0.09
2mm	16mm	20mm	0480755	0.11
2mm	17mm	21mm	0480756	0.11
2mm	18mm	22mm	0480757	0.11
2mm	20mm	24mm	0480758	0.11
2mm	22mm	26mm	0480759	0.14
2mm	30mm	34mm	0480760	0.18
2mm	40mm	44mm	0480761	0.23
2.5mm	10mm	15mm	0480762	0.09
2.5mm	11mm	16mm	0480763	0.09
2.5mm	12mm	17mm	0480764	0.09
2.5mm	13mm	18mm	0480765	0.10
2.5mm	14mm	19mm	0480766	0.10
2.5mm	15mm	20mm	0480767	0.10
2.5mm	16mm	21mm	0480768	0.12
2.5mm	17mm	22mm	0480769	0.12
2.5mm	18mm	23mm	0480770	0.12
2.5mm	19mm	24mm	0480771	0.14
2.5mm	22mm	27mm	0480772	0.15
2.5mm	25mm	30mm	0480773	0.22
3mm	9mm	15mm	0480774	0.08
3mm	12mm	18mm	0480775	0.09
3mm	14mm	20mm	0480776	0.11
3mm	15mm	21mm	0480777	0.12
3mm	16mm	22mm	0480778	0.13
3mm	18mm	24mm	0480779	0.13
3mm	19mm	25mm	0480780	0.13
3mm	20mm	26mm	0480781	0.15
3mm	22mm	28mm	0480782	0.15
3mm	24mm	30mm	0480783	0.15
3mm	25mm	31mm	0480784	0.15
3mm	27mm	33mm	0480785	0.18
3mm	28mm	34mm	0480786	0.18
3mm	30mm	36mm	0480787	0.18
3mm	32mm	38mm	0480788	0.23
3mm	33mm	39mm	0480789	0.23
3mm	34mm	40mm	0480790	0.23
3mm	35mm	41mm	0480791	0.23
3mm	36mm	42mm	0480792	0.25
3mm	38mm	44mm	0480793	0.25
3mm	44mm	50mm	0480794	0.29
3mm	45mm	51mm	0480795	0.29
3mm	54mm	60mm	0480796	0.37
4mm	38mm	46mm	0480797	0.34
4mm	41mm	49mm	0480798	0.34
4mm	44mm	52mm	0480799	0.38

Viton® Fluorocarbon

1/16" Cross Section

- Recommended for hydraulic applications
- 75 durometer
- Brown in color

Trade Size	I.D.	O.D.	Part No.	Price /Each
006	1/8	1/4	0480858	\$0.13
007	5/32	9/32	0480859	0.13
008	3/16	5/16	0480860	0.13
009	7/32	11/32	0480861	0.13
010	1/4	3/8	0480862	0.13
011	5/16	7/16	0480863	0.14
012	3/8	1/2	0480864	0.16
013	7/16	9/16	0480865	0.19
014	1/2	5/8	0480866	0.19
015	9/16	11/16	0480867	0.23
016	5/8	3/4	0480868	0.23
017	11/16	13/16	0480869	0.23
018	3/4	7/8	0480870	0.26
020	7/8	1	0480871	0.29
022	1	1-1/8	0480872	0.31
024	1-1/8	1-1/4	0480873	0.35

Viton® Fluorocarbon

3/32" Cross Section

- Recommended for hydraulic applications
- 75 durometer
- Brown in color

Trade Size	I.D.	O.D.	Part No.	Price /Each
110	3/8	9/16	0480874	\$0.24
111	7/16	5/8	0480875	0.25
112	1/2	11/16	0480876	0.28
113	9/16	3/4	0480877	0.28
114	5/8	13/16	0480878	0.28
115	11/16	7/8	0480879	0.30
116	3/4	15/16	0480880	0.35
118	7/8	1-1/16	0480881	0.41
121	1-1/16	1-1/4	0480882	0.52
122	1-1/8	1-5/16	0480883	0.56
124	1-1/4	1-7/16	0480884	0.58
125	1-5/16	1-1/2	0480885	0.61
126	1-3/8	1-9/16	0480886	0.63
128	1-1/2	1-11/16	0480887	0.66
129	1-9/16	1-3/4	0480888	0.70
130	1-5/8	1-13/16	0480889	0.73
133	1-13/16	2	0480890	0.77

Viton® Fluorocarbon

1/8" Cross Section

- Recommended for hydraulic applications
- 75 durometer
- Brown in color

Trade Size	I.D.	O.D.	Part No.	Price /Each
210	3/4	1	0480891	\$0.59
211	13/16	1-1/16	0480892	0.62
212	7/8	1-1/8	0480893	0.65
213	15/16	1-3/16	0480894	0.70
214	1	1-1/4	0480895	0.71
215	1-1/16	1-5/16	0480896	0.75
216	1-1/8	1-3/8	0480897	0.77
217	1-3/16	1-7/16	0480898	0.80
218	1-1/4	1-1/2	0480899	0.86
219	1-5/16	1-9/16	0480900	0.86
220	1-3/8	1-5/8	0480901	0.91
221	1-7/16	1-11/16	0480902	1.19
222	1-1/2	1-3/4	0480903	1.29

Viton® Fluorocarbon

3/16" Cross Section

- Recommended for hydraulic applications
- 75 durometer
- Brown in color

Trade Size	I.D.	O.D.	Part No.	Price /Each
325	1-1/2	1-7/8	0480904	\$2.36
326	1-5/8	2	0480905	2.54
327	1-3/4	2-1/8	0480906	2.62
328	1-7/8	2-1/4	0480907	2.73

Viton® is a registered trademark of E.I. DuPont.

Rubber O-Ring Drawer Kit Buna N - Large Diameters Part #99354

Use in conjunction with insert card #99355 and drawer (not included).



Part No.	Price /Each
99354	\$26.52

Contains the following O-Rings:

Trade Size	Part No.	Qty.
#216	66853	10
#217	66854	10
#218	66855	10
#219	66856	10
#220	66857	10
#221	66858	10
#222	66859	10
#325	66886	10
#326	66887	10
#327	66888	10
#329	66889	10
#330	66890	10
#333	66891	10
#339	66893	10

O-RINGS AND FLANGE GASKETS

O-Rings Cont.



Rubber O-Ring Drawer Kit Buna N - Small Diameters Part #99351

Use in conjunction with insert card #99352 and drawer (not included).

Active Cleaner		Rubber O-Rings - Small Sizes	
1/2"	1/2"	3/4"	3/4"
1"	1"	1-1/4"	1-1/4"
1-1/2"	1-1/2"	1-1/2"	1-1/2"
2"	2"	2-1/2"	2-1/2"
3"	3"	3-1/2"	3-1/2"
4"	4"	4"	4"
5"	5"	5"	5"
6"	6"	6"	6"
8"	8"	8"	8"
10"	10"	10"	10"
12"	12"	12"	12"

Part No.	Price /Each
99351	\$21.95

Contains the following O-Rings:

Trade Size	Part No.	Qty.
#006	66800	25
#007	66801	25
#008	66802	25
#009	66803	25
#010	66804	25
#011	66805	25
#012	66806	25
#013	66807	25
#015	66809	25
#017	6681	25
#110	66822	25
#111	66823	25
#112	66824	10
#113	66825	10
#114	66826	10
#115	66827	10
#116	66828	10
#210	66847	10
#211	66848	10
#212	66849	10
#213	66850	10
#214	66851	10

Flange Gaskets



Red Rubber Ring Gasket 1/16"



150 lb Rating		
Size	Part No.	Price /Each
1/2	0479950	\$0.14
3/4	0479951	0.16
1	0479952	0.16
1-1/4	0479953	0.16
1-1/2	0479954	0.21
2	0479955	0.27
2-1/2	0479956	0.32
3	0479957	0.32
3-1/2	0479958	0.43
4	0479959	0.48
5	0479960	0.62
6	0479961	0.70
8	0479962	1.00
10	0479963	1.39
12	0479964	1.93

Red Rubber Ring Gasket 1/8"



Size	150 lb Rating		300 lb Rating	
	Part No.	Price /Each	Part No.	Price /Each
3/4	0479966	\$0.27		
1	0479967	0.32	0480027	0.34
1-1/4	0479968	0.32	0480028	0.38
1-1/2	0479969	0.38	0480029	0.43
2	0479970	0.54	0480030	0.57
2-1/2	0479971	0.59	0480031	0.62
3	0479972	0.75	0480032	0.78
3-1/2	0479973	0.80	0480033	0.86
4	0479974	1.08	0480034	1.10
5	0479975	1.34	0480035	1.38
6	0479976	1.61	0480036	1.67
8	0479977	2.26		
10	0479978	2.74		
12	0479979	4.14		

Non Asbestos Ring Gasket 1/16"



Size	150 lb Rating		300 lb Rating	
	Part No.	Price /Each	Part No.	Price /Each
1/2	0479980	\$0.16		
3/4	0479981	0.32		
1	0479982	0.38	0480042	0.43
1-1/4	0479983	0.45	0480043	0.62
1-1/2	0479984	0.70	0480044	0.78
2	0479985	0.96	0480045	0.99
2-1/2	0479986	1.24	0480046	1.27
3	0479987	1.51	0480047	1.56
3-1/2	0479988	1.73		
4	0479989	2.31	0480049	2.39
5	0479990	2.39		
6	0479991	2.85		
8	0479992	4.26		
10	0479993	7.03		
12	0479994	10.13		

Non Asbestos Ring Gasket 1/8"



Size	150 lb Rating		300 lb Rating	
	Part No.	Price /Each	Part No.	Price /Each
1/2	0479995	\$0.38		
3/4	0479996	0.64		
1	0479997	0.92		
1-1/4	0479998	1.02		
1-1/2	0479999	1.25		
2	0480000	1.94	0480060	1.94
2-1/2	0480001	2.15	0480061	2.36
3	0480002	2.80	0480062	3.01
3-1/2	0480003	3.54	0480063	3.65
4	0480004	4.51	0480064	4.89
5	0480005	4.85	0480065	5.69
6	0480006	6.06	0480066	7.50
8	0480007	9.27	0480067	11.31
10	0480008	13.83	0480068	15.49
12	0480009	20.75	0480069	21.25

Red Rubber Full Face Gasket 1/16"



150 lb Rating		
Size	Part No.	Price /Each
3/4	0480071	\$0.21
1	0480072	0.27
1-1/4	0480073	0.27
1-1/2	0480074	0.32
2	0480075	0.38
2-1/2	0480076	0.48
3	0480077	0.54
3-1/2	0480078	0.64
4	0480079	0.70
5	0480080	0.80
6	0480081	0.96
8	0480082	1.39
10	0480083	2.50
12	0480084	3.09

Red Rubber Full Face Gasket 1/8"



Size	150 lb Rating		300 lb Rating	
	Part No.	Price /Each	Part No.	Price /Each
1/2	0480085	\$0.38		
3/4	0480086	0.41		
1	0480087	0.48	0480147	0.59
1-1/4	0480088	0.54	0480148	0.64
1-1/2	0480089	0.59	0480149	0.75
2	0480090	0.70	0480150	0.86
2-1/2	0480091	1.08	0480151	1.10
3	0480092	1.24	0480152	1.27
3-1/2	0480093	1.29	0480153	1.46
4	0480094	1.85	0480154	1.89
5	0480095	2.22	0480155	2.29
6	0480096	2.42	0480156	2.71
8	0480097	3.04	0480157	3.66
10	0480098	5.25	0480158	6.53
12	0480099	6.91		

Miscellaneous

FLANGE GASKETS AND E-CLIPS

Flange Gaskets Cont.



Non Asbestos Full Face Gasket 1/16"



Size	150 lb Rating		300 lb Rating	
	Part No.	Price /Each	Part No.	Price /Each
3/4	0480101	\$0.83		
1	0480102	0.96		
1-1/4	0480103	1.08		
1-1/2	0480104	1.24	0480164	1.72
2	0480105	1.89	0480165	1.93
2-1/2	0480106	2.09	0480166	2.39
3	0480107	2.44	0480167	2.98
3-1/2	0480108	3.03	0480168	3.44
4	0480109	3.44	0480169	4.27
5	0480110	4.10	0480170	4.80
6	0480111	4.66	0480171	5.98
8	0480112	6.70	0480172	8.23
10	0480113	10.56	0480173	11.15
12	0480114	14.43	0480174	15.31

Non Asbestos Full Face Gasket 1/8"



Size	150 lb Rating		300 lb Rating	
	Part No.	Price /Each	Part No.	Price /Each
3/4	0480116	\$1.66		
1	0480117	1.78		
1-1/4	0480118	2.15		
1-1/2	0480119	2.50	0480179	3.33
2	0480120	4.05	0480180	4.45
2-1/2	0480121	4.21		
3	0480122	5.53	0480182	5.98
3-1/2	0480123	6.09		
4	0480124	7.19	0480184	8.53
5	0480125	8.39		
6	0480126	9.94	0480186	10.71
8	0480127	13.89	0480187	16.83
10	0480128	21.11		
12	0480129	26.17		

Miscellaneous

E-Clips

Carbon Spring Steel (Fractional) E-Clips

- Made from SAE 1060-1090 carbon steel
- Phosphate finish



Shaft Dia.	Thickness	Outside Clearance	Diameter	Vendor No.	Small Pack			Standard Pack			Bulk Pack		
					Part No.	Pkg. Qty.	Price /Each	Part No.	Pkg. Qty.	Price /Each	Part No.	Pkg. Qty.	Price /Each
1/8	.015	.230	E-12ST PA	1168075	25	\$1.70	68075	100	\$5.57	0401249	1000	\$33.00	
3/16	.025	.335	E-18ST PA	1168076	25	1.98	68076	100	5.80	0401251	1000	36.40	
1/4	.025	.527	E-25ST PA	1168077	20	1.58	68077	100	6.90	0401252	1000	41.20	
5/16	.025	.500	E-31ST PA	1168078	20	1.81	68078	100	6.26	0401345	1000	40.60	
3/8	.035	.660	E-37ST PA	1168079	15	1.86	68079	100	8.69	0401253	1000	60.60	
7/16	.035	.687	E-43ST PA	1168080	10	1.47	68080	100	9.51	0401254	1000	66.10	
1/2	.042	.800	E-50ST PA	1168081	10	1.58	68081	100	10.43	0401255	1000	80.10	
5/8	.042	.940	E-62ST PA	1168083	5	1.24	68083	100	13.84	0401256	1000	101.90	
3/4	.050	1.120	E-75ST PA	1168085	5	1.30	68085	100	23.49	0401258	1000	141.40	
7/8	.050	1.300	E-87ST PA	1168087	5	1.47	68087	100	22.99	0401259	1000	169.30	
1	.050	1.500	E-98ST PA	1168089	5	1.92	68089	100	31.51	0401346	1000	206.20	

Carbon Spring Steel (Metric) E-Clips

- Meet DIN Standards
- Carbon Steel Rings are made from SAE1060-1090 steel
- Phosphate finish



Part No.	Vendor No.	Size	Price /Ea
0423300	DE-2.3ST PA	2.3mm	\$0.04
0423301	DE-3.2ST PA	3.2mm	0.04
0423302	DE-4ST PA	4mm	0.04
0423303	DE-5ST PA	5mm	0.04
0423304	DE-6ST PA	6mm	0.05
0423305	DE-7ST PA	7mm	0.06
0423306	DE-8ST PA	8mm	0.07
0423307	DE-9ST PA	9mm	0.09
0423308	DE-10ST PA	10mm	0.10
0423309	DE-12ST PA	12mm	0.15
0423310	DE-15ST PA	15mm	0.19
0423311	DE-19ST PA	19mm	0.25

Stainless Steel E-Clips

- Meet ASME Standards
- Stainless Steel Rings are made from PH 15-7 Mo stainless steel
- Rings applied directly to the groove from the side of the shaft
- Ring provides a shoulder to retain assemblies
- Ideal for replacing machine shoulders and pin assemblies



Part No.	Vendor No.	Size	Price /Ea
0423412	SE-6SS	1/16	\$0.14
0423413	E-9SS	3/32	0.14
0423415	E-12SS	1/8	0.15
0423417	E-15SS	5/32	0.17
0423419	E-18SS	3/16	0.18
0423420	SE-21SS	7/32	0.22
0423421	E-25SS	1/4	0.26
0423422	SE-31SS	5/16	0.26
0423423	E-37SS	3/8	0.41
0423424	E-43SS	7/16	0.46
0423425	E-50SS	1/2	0.60
0423426	E-62SS	5/8	0.85
0423427	SE-74SS	3/4	1.09
0423428	E-87SS	7/8	1.89
0423429	SE-98SS	1	2.55
0423430	SE-118SS	1-3/16	3.49

EXTERNAL RETAINING RINGS AND E-CLIPS

E-Clips



E-Clip Hand Kit Part #99110



Part No.	Price /Each
99110	\$37.06

Contains the following E-Clips:

Shaft Dia.	Part No.	Qty.
1/8	68075	30
5/32	68071	20
3/16	68076	30
7/32	68072	20
1/4	68077	30
5/16	68078	30
3/8	68079	30
7/16	68080	25
1/2	68081	20
5/8	68083	15
3/4	68085	10
7/8	68087	5

Metric E-Clip Hand Kit Part # 0431274

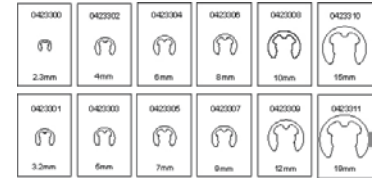

Part No.	Price /Each
0431274	\$34.00

Contains the following E-Clips

Size	Part No.	Qty.
2.3mm	0423300	20
3.2mm	0423301	20
4mm	0423302	20
5mm	0423303	20
6mm	0423304	20
7mm	0423305	20
8mm	0423306	20
9mm	0423307	20
10mm	0423308	20
12mm	0423309	20
15mm	0423310	20
19mm	0423311	20

External Retaining Rings (Fractional)

• Carbon Spring Steel, phosphate finish



Shaft Dia.	Thickness	Vendor No.	Small Pack			Standard Pack			Bulk Pack		
			Part No.	Pkg. Qty.	Price /Pkg.	Part No.	Pkg. Qty.	Price /Pkg.	Part No.	Pkg. Qty.	Price /Pkg.
5/32	.025	SH-15ST PA				68002	100	\$12.86	0401359	1000	\$37.50
7/32	.025	SH-21ST PA				68003	100	15.00	0401370	1000	41.60
9/32	.025	SH-28ST PA				68004	100	9.65	0401382	1000	45.30
1/8	.025	SH-12ST PA	1168005	15	2.03	68005	100	13.56	0401353	1000	52.50
3/16	.025	SH-18ST PA	1168006	15	2.54	68006	100	14.35	0401365	1000	58.70
1/4	.025	SH-25ST PA	1168007	15	1.53	68007	100	8.65	0401377	1000	44.50
5/16	.025	SH-31ST PA	1168008	15	1.70	68008	100	9.47	0401388	1000	46.10
11/32	.062	SH-34ST PA				68009	100	16.35	0401392	1000	47.30
3/8	.025	SH-37ST PA	1168009	15	1.70	68009	100	9.64	0401397	1000	48.90
13/32	.062	SH-40ST PA				68101	100	18.84	0401401	1000	79.80
7/16	.025	SH-43ST PA	1168010	15	1.86	68010	100	12.43	0401404	1000	71.00
1/2	.035	SH-50ST PA	1168011	15	2.03	68011	100	11.90	0401408	1000	67.80
9/16	.035	SH-56ST PA	1168012	10	1.47	68012	100	12.85	0401411	1000	74.70
19/32	.062	SH-59ST PA	1168102	10	2.37	68102	100	20.56	0401413	1000	97.50
5/8	.035	SH-62ST PA	1168013	10	1.70	68013	100	15.00	0401416	1000	79.60
11/16	.042	SH-68ST PA	1168014	10	1.92	68014	100	16.71	0401420	1000	88.90
3/4	.042	SH-75ST PA	1168015	10	2.03	68015	100	18.00	0401423	1000	94.10
25/32	.062	SH-78ST PA	1168104	5	1.19	68104	100	19.48	0401424	1000	94.20
13/16	.042	SH-81ST PA	1168016	5	1.13	68016	100	18.77	0401426	1000	99.10
7/8	.042	SH-87ST PA	1168017	5	1.19	68017	100	20.06	0401428	1000	108.80
15/16	.042	SH-93ST PA	1168018	5	1.30	68018	100	22.07	0401430	1000	126.60
1	.042	SH-100ST PA	1168019	5	1.41	68019	100	23.63	0401348	1000	135.90
1-1/16	.050	SH-106ST PA	1168020	5	1.70	68020	100	28.14	0401349	1000	152.00
1-1/8	.050	SH-112ST PA	1168021	5	1.75	68021	100	29.80	0401350	1000	168.20
1-3/16	.050	SH-118ST PA	1168022	5	1.81	68022	100	31.20	0401351	1000	176.30
1-1/4	.050	SH-125ST PA	1168023	5	1.92	68023	100	33.43	0401352	1000	182.80
1-5/16	.050	SH-131ST PA	1168024	3	1.29	68024	100	35.31	0401354	1000	188.80
1-3/8	.050	SH-137ST PA	1168025	3	1.39	68025	100	39.00	0401355	1000	197.00
1-7/16	.050	SH-143ST PA	1168026	3	1.56	68026	100	45.42	0401356	1000	254.20
1-1/2	.050	SH-150ST PA	1168027	3	1.63	68027	100	46.80	0401357	1000	230.90
1-9/16	.062	SH-156ST PA	1168028	3	1.76	68028	100	51.10	0401358	1000	291.20
1-5/8	.062	SH-162ST PA	1168029	2	1.51	68029	100	64.11	0401360	1000	338.60
1-11/16	.062	SH-168ST PA				68030	100	62.13	0401361	1000	322.30
1-3/4	.062	SH-175ST PA	1168031	2	1.56	68031	100	66.85	0401362	1000	370.00
1-13/16	.062	SH-181ST PA				68032	100	68.16	0401363	1000	385.80
1-7/8	.062	SH-187ST PA	1168033	2	1.70	68033	50	35.86	0401364	1000	402.80
2	.062	SH-200ST PA	1168034	2	1.81	68034	50	39.00	0401366	1000	439.20

The : symbol after a price denotes that it is a Direct Ship Product (DSP) and shipping, availability & lead times may vary.

EXTERNAL RETAINING RINGS

Retaining Rings



Steel External Retaining Rings Metric - DIN 471



Size	Small Pack			Standard Pack		
	Part No.	Pkg. Qty.	Price /Pkg.	Part No.	Pkg. Qty.	Price /Pkg.
M4				35300	100	\$7.06
M5				35301	100	8.03
M6	1135302	15	1.50	35302	100	8.52
M7				35303	100	8.75
M8	1135304	15	1.50	35304	100	8.82
M9				35305	100	13.95
M10	1135306	15	1.80	35306	100	9.37
M11				35307	100	7.38
M12	1135308	10	1.40	35308	100	5.54
M13				35309	100	7.42
M14	1135310	10	1.60	35310	100	8.08
M15	1135311	10	1.70	35311	100	8.68
M16	1135312	10	1.90	35312	100	8.24
M17	1135313	5	1.05	35313	100	9.80
M18	1135314	5	1.10	35314	100	10.45
M19				35315	100	11.47
M20	1135316	5	1.20	35316	100	11.55
M21				35317	100	12.60
M22				35318	100	14.24
M23				35319	100	17.77
M24				35320	100	18.21
M25	1135321	5	1.55	35321	100	17.91
M26				35322	100	17.95
M27				35323	100	22.43
M28				35324	100	23.48
M29				35325	100	33.53
M30	1135326	3	1.50	35326	100	16.72
M31				35327	100	34.20
M32				35328	100	37.11
M33				35329	100	38.86
M34				35330	100	38.98
M35	1135331	2	1.38	35331	100	40.93
M36				35332	100	46.92
M37				35333	100	47.08
M38				35334	100	52.33
M39				35335	100	52.60
M41				35337	100	62.59
M42				35338	100	62.75
M44				35339	100	68.68
M45	1135340	1	1.34	35340	100	68.84
M46				35341	100	74.98
M47				35342	50	37.60
M48				35343	50	39.32
M50	1135344	1	1.61	35344	50	40.40
M52				35345	50	46.03
M56				35348	50	49.04
M57				35349	50	53.00
M58				35350	50	53.50
M60				35351	25	27.75
M62				35352	25	29.50
M63				35353	25	30.50
M65				35354	25	35.00
M67				35355	25	35.75
M68				35356	25	36.00
M70				35357	25	38.25
M72				35358	25	39.00
M75				35359	5	7.80

Size	Small Pack			Standard Pack		
	Part No.	Pkg. Qty.	Price /Each	Part No.	Pkg. Qty.	Price /Each
M77				35360	5	\$8.45
M78				35361	5	8.45
M80				35362	5	9.00
M82				35363	5	9.80
M85				35364	5	12.60
M87				35365	5	12.60
M88				35366	5	12.65
M90				35367	5	12.70
M92				35368	5	12.75
M95				35369	5	12.85
M97				35370	5	14.95
M98				35371	5	13.40
M100				35372	5	13.90

Stainless Steel External Retaining Rings

- Meet ASME Standards
- Stainless Steel Rings are made from PH 15-7 Mo stainless steel
- Meets ASME standards
- Easily installed and removed by the plier holes
- Expand to pass over shaft and spring into groove when released
- Tapered section provides constant pressure to secure against heavy thrust loads



Size	Part No.	Vendor No.	Price /Ea
1/4	0423350	SH-25SS	\$0.59
9/32	0423351	SH-28SS	0.59
5/16	0423352	SH-31SS	0.59
3/8	0423354	SH-37SS	0.60
13/32	0423355	SH-40SS	0.61
7/16	0423356	SH-43SS	0.62
1/2	0423357	SH-50SS	0.68
9/16	0423358	SH-56SS	0.73
19/32	0423359	SH-59SS	0.74
5/8	0423360	SH-62SS	0.76
11/16	0423361	SH-68SS	0.82
3/4	0423362	SH-75SS	0.91
13/16	0423363	SH-81SS	0.98
7/8	0423364	SH-87SS	1.02
15/16	0423365	SH-93SS	1.10
63/64	0423366	SH-98SS	1.16
1	0423367	SH-100SS	1.18
1 1/16	0423368	SH-106SS	1.66
1 1/8	0423369	SH-112SS	1.77
1 3/16	0423370	SH-118SS	1.87
1 1/4	0423371	SH-125SS	1.99
1 5/16	0423372	SH-131SS	2.08
1 3/8	0423373	SH-137SS	2.18
1 7/16	0423374	SH-143SS	2.27
1 1/2	0423375	SH-150SS	2.37
1 9/16	0423376	SH-156SS	3.52
1 5/8	0423377	SH-162SS	3.76
1 3/4	0423379	SH-175SS	4.52
1 7/8	0423380	SH-187SS	5.05
2	0423381	SH-200SS	5.56



External Retaining Ring Hand Kit Part #99108

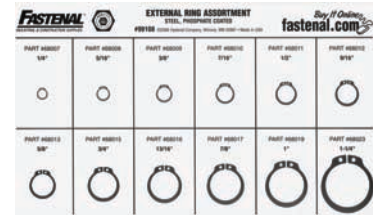

Part No.	Price /Each
99108	\$39.75

Contains the following Retaining Rings:

Trade Size	Part No.	Qty.
1/4	68007	30
5/16	68008	20
3/8	68009	50
7/16	68010	20
1/2	68011	50
9/16	68012	20
5/8	68013	30
3/4	68015	35
13/16	68016	10
7/8	68017	20
1	68019	10
1-1/4	68023	5

Metric External Retaining Ring Hand Kit Part # 0431276

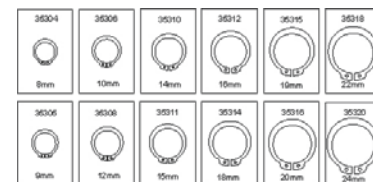

Part No.	Price /Each
0431276	\$39.75

Contains the following Retaining Rings

Size	Part No.	Qty.
8mm	35304	20
9mm	35305	20
10mm	35306	20
12mm	35308	20
14mm	35310	20
15mm	35311	20
16mm	35312	20
18mm	35314	20
19mm	35315	20
20mm	35316	20
22mm	35318	20
24mm	35320	20

EXTERNAL & INTERNAL RETAINING RINGS

Retaining Rings Cont.

FASTENAL



External Retaining Ring Drawer Kit Part #99348

Use in conjunction with insert card #99349 and drawer (not included).



Part No.	Price /Each
99348	\$69.10

Contains the following Retaining Rings:

Trade Size	Part No.	Qty.	Trade Size	Part No.	Qty.
1/8	68005	25	1	68019	10
3/16	68006	25	1-3/16	68022	15
1/4	68007	30	1-1/4	68023	5
5/16	68008	20	1-5/16	68024	15
3/8	68009	50	1-3/8	68025	10
7/16	68010	20	1-7/16	68026	10
1/2	68011	50	1-1/2	68027	10
9/16	68012	20	1-9/16	68028	10
5/8	68013	30	1-5/8	68029	10
11/16	68014	15	1-3/4	68031	10
3/4	68015	35	1-7/8	68033	10
7/8	68017	20	2	68034	10

Retaining Rings:
 Tapered Section
 Constant Section
 Spiral Rings
 Inch - Metric - ANSI - JIS
 Stainless Inch & Metric

Full Tool Support.
 Low Quantity Orders Through RotorExpress®
 Mil-Spec Rings With True MS Certs.
 Certified to TS 16949:2002.

Internal Retaining Rings

- Carbon Spring Steel
- Phosphate finish



Diameter	Thickness	Vendor No.	Small Pack			Standard Pack			Bulk Pack		
			Part No.	Pkg. Qty.	Price /Pkg.	Part No.	Pkg. Qty.	Price /Pkg.	Part No.	Pkg. Qty.	Price /Pkg.
1/4	.062	HO-25ST PA	1168150	20	\$1.81	68150	100	\$6.92	0401287	1000	\$48.10
5/16	.015	HO-31ST PA	1168040	15	1.70	68040	100	8.65	0401296	1000	49.80
3/8	.025	HO-37ST PA	1168041	15	1.86	68041	100	9.55	0401303	1000	58.90
7/16	.025	HO-43ST PA	1168042	15	1.86	68042	100	11.12	0401309	1000	61.80
1/2	.035	HO-50ST PA	1168043	15	2.03	68043	100	11.58	0401315	1000	67.80
9/16	.035	HO-56ST PA	1168044	10	1.47	68044	100	11.83	0401319	1000	62.30
5/8	.035	HO-62ST PA	1168045	10	1.58	68045	100	12.68	0401323	1000	67.10
11/16	.035	HO-68ST PA	1168046	10	1.70	68046	100	14.16	0401327	1000	81.20
3/4	.035	HO-75ST PA	1168047	10	1.81	68047	100	15.39	0401331	1000	85.20
13/16	.042	HO-81ST PA	1168048	10	1.92	68048	100	15.60	0401334	1000	89.40
7/8	.042	HO-87ST PA	1168049	10	2.03	68049	100	17.13	0401338	1000	96.60
15/16	.042	HO-93ST PA	1168050	5	1.19	68050	100	19.12	0401340	1000	103.90
1	.042	HO-100ST PA	1168051	5	1.24	68051	100	20.15	0401261	1000	112.20
1-1/16	.050	HO-106ST PA	1168052	5	1.30	68052	100	21.54	0401262	1000	136.70
1-1/8	.050	HO-112ST PA	1168053	5	1.47	68053	100	24.15	0401263	1000	146.80
1-3/16	.050	HO-118ST PA	1168054	5	1.53	68054	100	24.45	0401264	1000	149.80
1-1/4	.050	HO-125ST PA	1168055	5	1.58	68055	100	26.14	0401265	1000	158.10
1-5/16	.050	HO-131ST PA	1168056	5	1.64	68056	100	27.49	0401266	1000	165.40
1-3/8	.050	HO-137ST PA	1168057	5	1.75	68057	100	28.76	0401267	1000	175.90
1-7/16	.050	HO-143ST PA	1168058	5	1.92	68058	100	32.23	0401268	1000	185.20
1-1/2	.050	HO-150ST PA	1168059	5	2.26	68059	100	39.21	0401269	1000	196.10
1-9/16	.062	HO-156ST PA	1168060	3	1.56	68060	100	42.74	0401270	1000	249.10
1-5/8	.062	HO-162ST PA	1168061	3	1.76	68061	100	48.60	0401271	1000	256.40
1-11/16	.062	HO-168ST PA				68062	50	29.36	0401272	1000	271.00
1-3/4	.062	HO-175ST PA	1168063	2	1.76	68063	50	31.32	0401273	1000	306.50
1-13/16	.062	HO-181ST PA				68064	50	32.32	0401274	1000	343.10
1-7/8	.062	HO-187ST PA	1168065	2	1.88	68065	50	34.16	0401275	1000	345.80
1-15/16	.062	HO-193ST PA				68152	50	35.52	0401276	1000	363.40
2	.062	HO-200ST PA	1168066	2	1.92	68066	50	37.02	0401277	1000	387.60

The : symbol after a price denotes that it is a Direct Ship Product (DSP) and shipping, availability & lead times may vary.

INTERNAL RETAINING RINGS

Retaining Rings Cont.



Steel Internal Retaining Rings Metric - DIN 472



Size	Part No.	Pkg. Qty.	Price /Pkg.
M8	35200	100	\$6.70
M9	35201	100	7.21
M10	35202	100	8.24
M11	35203	100	8.76
M12	35204	100	10.30
M13	35205	100	11.18
M14	35206	100	12.48
M15	35207	100	12.88
M16	35208	100	13.93
M17	35209	100	16.19
M18	35210	100	15.81
M19	35211	100	16.39
M20	35212	100	16.07
M21	35213	100	16.61
M22	35214	100	16.48
M23	35215	100	17.00
M24	35216	100	17.51
M25	35217	100	18.54
M26	35218	100	19.57
M27	35219	100	22.66
M28	35220	100	25.75
M29	35221	100	28.84
M30	35222	100	30.90
M31	35223	100	32.96
M32	35224	100	36.05
M33	35225	100	39.14
M34	35226	100	41.20
M35	35227	100	43.26
M36	35228	100	46.35
M37	35229	100	54.27
M38	35230	100	51.50
M39	35231	100	25.00
M40	35232	100	56.65
M41	35233	100	65.56
M42	35234	100	30.90
M43	35235	50	37.49
M44	35236	50	37.08
M45	35237	50	38.11
M46	35238	50	39.14
M47	35239	50	41.78
M48	35240	50	41.20
M49	35241	50	45.00
M50	35242	50	48.07
M51	35243	50	57.00
M52	35244	50	62.50
M53	35245	50	62.00
M54	35246	50	30.50
M55	35247	50	62.00
M56	35248	50	70.00
M57	35249	50	76.00
M58	35250	50	75.00
M60	35251	50	77.50
M62	35252	25	44.25
M63	35253	25	43.25
M65	35254	25	42.50
M67	35255	25	44.50
M68	35256	25	46.50
M70	35257	5	45.25

Size	Part No.	Pkg. Qty.	Price /Pkg.
M72	35258	5	\$46.50
M75	35259	5	9.55
M77	35260	5	10.10
M78	35261	5	10.60
M80	35262	5	10.30
M82	35263	5	11.05
M85	35264	5	12.90
M87	35265	5	14.00
M88	35266	5	14.85
M90	35267	5	15.75
M92	35268	5	16.00
M95	35269	5	19.00
M97	35270	5	19.35
M98	35271	5	20.60
M100	35272	2	8.76

Stainless Steel Internal Retaining Rings

- Meet ASME Standards
- Stainless Steel Rings are made from PH 15-7 Mo stainless steel
- Rings are compressed into a bore or housing
- The portion of the ring protruding from the groove holds an assembly in place
- Easily installed and removed by the plier holes



Size	Part No.	Vendor No.	Price /Ea
1/4	0423382	HO-25SS	\$0.64
5/16	0423383	HO-31SS	0.65
3/8	0423384	HO-37SS	0.67
7/16	0423385	HO-43SS	0.69
1/2	0423386	HO-50SS	0.73
9/16	0423387	HO-56SS	0.78
5/8	0423388	HO-62SS	0.81
11/16	0423389	HO-68SS	0.85
3/4	0423390	HO-75SS	0.89
13/16	0423392	HO-81SS	1.02
7/8	0423393	HO-87SS	1.08
15/16	0423395	HO-93SS	1.12
1	0423396	HO-100SS	1.20
1 1/16	0423398	HO-106SS	1.50
1 1/8	0423399	HO-112SS	1.57
1 3/16	0423400	HO-118SS	1.64
1 1/4	0423401	HO-125SS	1.71
1 5/16	0423402	HO-131SS	1.80
1 3/8	0423403	HO-137SS	1.87
1 7/16	0423404	HO-143SS	1.97
1 1/2	0423405	HO-150SS	2.05
1 9/16	0423406	HO-156SS	2.72
1 5/8	0423407	HO-162SS	2.83
1 11/16	0423408	HO-168SS	2.96
1 3/4	0423409	HO-175SS	3.34
1 7/8	0423410	HO-187SS	3.58
2	0423411	HO-200SS	3.89



Fractional Internal Retaining Ring Hand Kit Part #99109

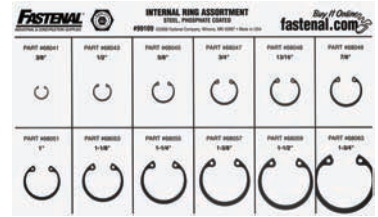

Part No.	Price /Each
99109	\$40.71

Contains the following Retaining Rings:

Trade Size	Part No.	Qty.
3/8	68041	25
1/2	68043	25
5/8	68045	25
3/4	68047	25
13/16	68048	25
7/8	68049	15
1	68051	15
1-1/8	68053	15
1-1/4	68055	10
1-3/8	68057	10
1-1/2	68059	5
1-3/4	68063	5

Metric Internal Retaining Ring Hand Kit Part # 0431275

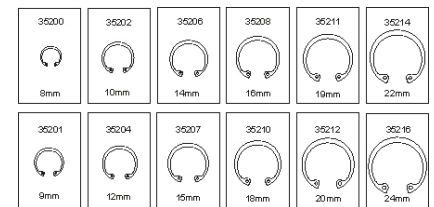

Part No.	Price /Each
0431275	\$39.00

Size	Part No.	Qty.
8mm	35200	20
9mm	35201	20
10mm	35202	20
12mm	35204	20
14mm	35206	20
15mm	35207	20
16mm	35208	20
18mm	35210	20
19mm	35211	20
20mm	35212	20
22mm	35214	20
24mm	35216	20

RETAINING RINGS & SPIRAL RINGS

Retaining Rings Cont.

FASTENAL®



Internal Retaining Ring Drawer Kit Part #99345



Use in conjunction with insert card #99346 and drawer (not included).

Part No.	Price /Each
99345	\$72.37

Contains the following Retaining Rings:

Shaft Dia.	Part No.	Qty.
7/16	68042	25
1/2	68043	15
9/16	68044	25
5/8	68045	15
11/16	68046	15
3/4	68047	15
13/16	68048	15
7/8	68049	15
15/16	68050	15
1	68051	10
1-1/16	68052	10
1-1/8	68053	10
1-1/4	68055	10
1-5/16	68056	25
1-3/8	68057	5
1-7/16	68058	25
1-1/2	68059	5
1-9/16	68060	10
1-5/8	68061	5
1-3/4	68063	5
1-7/8	68065	5
2	68066	5



Retaining Ring Pliers

- Crafted from drop forged chrome vanadium steel
- Single piece design provides superior strength and durability
- Internal and external styles available



Pn. 0266479



Pn. 0266480



Pn. 0266481



Pn. 0266482

Part No.	Length	Description	Price
0266479	7"	Straight Nose Internal Snap Ring Pliers	\$8.28
0266480	7"	Bent Nose Internal Snap Ring Pliers	9.04
0266481	7"	Straight Nose External Snap Ring Pliers	9.34
0266482	7"	Bent Nose External Snap Ring Pliers	8.29

Spiral Rings



External Light Duty



Size	Part No.	Vendor No.	Price /Each
1/2	0428209	VS-050	\$0.18
3/4	0428210	VS-075	0.21
7/8	0428211	VS-087	0.27
1	0428212	VS-100	0.27
1-1/8	0428213	VS-112	0.30
1-5/16	0428214	VS-131	0.32
1-3/8	0428215	VS-137	0.43
1-7/16	0428216	VS-143	0.48
1-5/8	0428217	VS-162	0.54
1-13/16	0428218	VS-181	0.59
1-15/16	0428219	VS-193	0.64
2	0428220	VS-200	0.70

Internal Light Duty



Size	Part No.	Vendor No.	Price /Each
1/2	0428221	VH-050	\$0.17
5/8	0428222	VH-062	0.24
3/4	0428223	VH-075	0.24
7/8	0428224	VH-087	0.25
1	0428225	VH-100	0.26
1-1/8	0428226	VH-112	0.27
1-1/4	0428227	VH-125	0.30
1-5/16	0428228	VH-131	0.32
1-3/8	0428229	VH-137	0.39
1-7/16	0428230	VH-143	0.43
1-1/2	0428231	VH-150	0.44
1-5/8	0428232	VH-162	0.51
1-3/4	0428233	VH-175	0.54
1-7/8	0428234	VH-187	0.54
2	0428235	VH-200	0.59

Internal Medium Duty



Size	Part No.	Vendor No.	Price /Each
1/2	0428236	WH-050	\$0.27
9/16	0428237	WH-056	0.29
19/32	0428238	WH-059	0.31
3/4	0428239	WH-075	0.33
7/8	0428240	WH-087	0.35
1	0428241	WH-100	0.38
1-1/8	0428242	WH-112	0.40
1-1/4	0428243	WH-125	0.42
1-5/16	0428244	WH-131	0.44
1-3/8	0428245	WH-137	0.46
1-7/16	0428246	WH-143	0.48
1-1/2	0428247	WH-150	0.50
1-5/8	0428248	WH-162	0.63
2	0428249	WH-200	0.89

External Medium Duty



Size	Part No.	Vendor No.	Price /Each
1/2	0428250	WS-050	\$0.30
5/8	0428251	WS-062	0.38
3/4	0428252	WS-075	0.36
7/8	0428253	WS-087	0.39
1	0428254	WS-100	0.43
1-1/4	0428255	WS-125	0.48
1-5/16	0428256	WS-131	0.51
1-3/8	0428257	WS-137	0.54
1-1/2	0428258	WS-150	0.64
1-5/8	0428259	WS-162	0.70
1-3/4	0428260	WS-175	0.75
2	0428261	WS-200	1.02

Internal Heavy Duty



Size	Part No.	Vendor No.	Price /Each
1/2	0428262	WHM-050	\$0.27
5/8	0428263	WHM-062	0.29
3/4	0428264	WHM-075	0.31
7/8	0428265	WHM-087	0.60
15/16	0428266	WHM-093	0.73
1-1/8	0428267	WHM-112	0.74
1-1/4	0428268	WHM-125	0.75
1-5/16	0428269	WHM-131	0.77
1-3/8	0428270	WHM-137	0.77
1-1/2	0428271	WHM-150	0.79
1-9/16	0428272	WHM-156	0.80
1-3/4	0428273	WHM-175	0.81
2	0428274	WHM-200	0.83

External Heavy Duty



Size	Part No.	Vendor No.	Price /Each
1/2	0428275	WSM-050	\$0.27
5/8	0428276	WSM-062	0.32
3/4	0428277	WSM-075	0.86
7/8	0428278	WSM-087	0.91
1	0428279	WSM-100	0.96
1-1/4	0428280	WSM-125	1.08
1-3/8	0428281	WSM-137	1.11
1-1/2	0428282	WSM-150	1.12
1-9/16	0428283	WSM-156	1.14
1-3/4	0428284	WSM-175	1.19
2	0428285	WSM-200	1.24

Miscellaneous

GREASE FITTINGS

Grease Fittings

Grease Fittings Zerk



45° Fitting

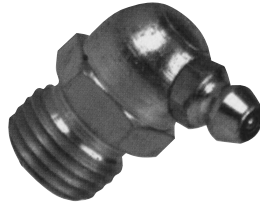

90° Fitting



Straight Fitting



Description	Features	Utility Line			Alemite Brand			Lincoln Brand		
		Part No.	Vendor No.	Price /Each	Part No.	Vendor No.	Price /Each	Part No.	Vendor No.	Price /Each
1/8 NPT	Straight - Short	58750	H1644	\$0.36	58793	1644-B	\$0.54			
1/8" NPT	Straight - Standard	60102	H1610*	0.29	58794	1610-BL	0.43	58836	5000	\$0.38
1/8 NPT	Straight - Long (1-1/4)	58752	H1607	0.73	58795	1607-B	1.15	58837	5003	1.61
1/8 NPT	Straight-Extra Long (1-3/4)	58753	H1669	0.96	58796	1669-B	1.77			
1/8 NPT	Straight-Super Long (2-5/8)	58754	H1684	1.11	58797	1684-B	2.80			
1/8 NPT	30° Angle	58755	H1611	0.48	58798	1611-B	1.36			
1/8" NPT	45° Angle	60103	H1688*	0.64	58799	1688-B	1.30	58838	5200	1.58
1/8 NPT	65° Angle	58757	H1612	0.57	58800	1612-B	1.51	58839	5300	1.18
1/8" NPT	90° Angle	60104	H1613*	0.58	58801	1613-B	0.86	58840	5400	1.33
1/8 NPT Female	Straight	58759	H1618	0.98	58802	1618-B	2.15	58841	5505	2.52
1/4 NPT	Straight	58760	H1627	0.73	58803	1627-B	0.91	58842	5050	0.98
1/4 NPT	67-1/2° Angle	58761	H1629	0.96	58804	1629-B	1.83	58843	5350	2.08
1/4"-28	Straight - Standard	60105	H1641*	0.20	58805	1641-B	0.23	58844	5010	0.47
1/4-28	Straight-Long Shank (11/16)	58763	H1652	0.30	58806	1652-B	0.38	58845	5013	0.68
1/4-28	Straight-Long (31/32)	58764	H1680	0.49	58807	1680-B	0.96			
1/4-28	Straight-Very Long (1-39/64)	58765	H3014	1.50	58808	3014-B	2.68			
1/4"-28	45° Angle	60106	H1637*	0.51	58809	1637-B1	0.80	58847	5210	1.58
1/4-28	45° Angle - Long (31/32)	58767	H1636	0.55						
1/4-28	65° Angle	58768	H3010	0.47	58811	3010-B	0.96	58848	700396	1.43
1/4"-28	90° Angle	60107	H1911*	0.51	58812	1911-B1	0.70	58849	5410	0.98
1/4-28	90° Angle-Long (51/64)	58770	H1790	0.68						
1/4-28 UNF-2A	Straight-Short Threads	58771	H1792	0.20	58814	1792-B	0.32	58850	5527	0.47
1/4-28 UNF-2A	45° Angle-Short Threads	58772	H1770	0.87	58815	1770-B1	1.34			
5/16-24 UNF 2A	Straight	58773	H1711	0.33	58816	1711-B	0.75			
3/8-24 UNF 2A	Straight	58774	H1710	0.36						
1/8 Drive	Straight - No Ball Check	58775	H3019	0.54	58818	3019	0.54			
3/16" Drive	Straight	60108	H1728*	0.23	58819	1728-B	0.32	58851	5033	0.58
3/16 Drive	Straight - No Ball Check	58777	H1633	0.31	58820	1633	0.43			
3/16 Drive	45° Angle	58778	H1992	0.88	58821	1992-B1	1.34			
1/4 Drive	Straight	58779	H1743	0.24	58822	1743-B	0.32			
1/4 Drive	Straight - No Ball Check	58780	H1952	0.31	58823	1952	0.43			
1/4 Drive	65° Angle	58781	H1744	0.88	58824	1744-B1	1.46			
5/16 Drive	Straight	58782	H1608	0.30	58825	1608-B	0.38	58854	5031	0.32
3/8 Drive	Straight - No Ball Check	58783	H1666	0.47	58826	1666	1.29			
1/8 NPT Button	Straight - Ball Check	58784	H1184	1.06	58828	A-1184	2.31	58855	5701	2.00
1/4 NPT Button	Straight - Ball Check	58785	H1186	1.30	58829	A-1186	2.53			
3/8 NPT Button	Straight - Ball Check	58786	H1188	1.74	58830	A-1188	3.22	58857	571	2.48
1/8 NPT	Self-Tapping Straight	58787	H1720	0.32	58831	1720-B	0.70			
1/8 NPT	Self-Tapping 45° Angle	58788	H1724	0.80						
1/8 NPT	Self-Tapping 90° Angle	58789	H1723	0.69	58833	1723-B	1.02			
1/4-28	Self-Tapping Straight	58790	H3038	0.67	58834	3038-B	0.27	58861	205010	0.47
1/4-28	Self-Tapping 45° Angle	58791	H3053	0.64	58835	3053-B	0.80			
1/4-28	Self-Tapping 90° Angle	58792	H3054	0.72	58817	3054-B	1.08			

*Most commonly used.

GREASE FITTINGS & OIL ACCESSORIES

Grease Fittings Cont.



Metric Grease Fittings



Part No.	Description	Features	Vendor No.	Price /Each
0496000	6mm x 1.0	Straight	H2106	\$0.36
0496001	6mm x 1.0	45° Angle	H2107	0.78
0496002	6mm x 1.0	90° Angle	H2108	0.84
0496003	8mm x 1.0	Straight	H2103	0.49
0496004	8mm x 1.0	45° Angle	H2104	0.96
0496005	8mm x 1.0	90° Angle	H2105	1.03
0496006	10mm x 1.0	Straight	H2109	0.49
0496007	10mm x 1.0	45° Angle	H2110	1.02
0496008	10mm x 1.0	90° Angle	H2111	1.02

Stainless Grease Fittings



Part No.	Description	Features	Vendor No.	Price /Each
0496009	1/8" NPT	Straight	H1610S	\$2.54
0496010	1/8" NPT	45° Angle	H1688S	4.63
0496011	1/8" NPT	85° (90°)	H1613S	4.63
0496012	1/4"-1/8" NPT	Straight	H1627S	6.15
0496013	1/4"-28	Straight	H1641S	1.40
0496014	1/4"-28	45° Angle	H1637S	3.63
0496015	1/4"-28	90° Angle	H1911S	3.99
0496016	3/16" Drive	Straight	H1728S	1.81
0496017	1/4" Drive	Straight	H1743S	1.97

Grease Fitting Hand Kit Part #99112



Part No.	99112
Price/Each	\$59.32

Contains the following Fittings:

Part No.	Description	Features	Quantity
60105	1/4-28	Straight	30
60106	1/4-28	45° Angle	10
60107	1/4-28	90° Angle	10
60102	1/8 NPT	Straight	30
60103	1/8 NPT	45° Angle	5
60104	1/8 NPT	90° Angle	5

Oil Accessories



Grease Guns & Accessories



Part No.	Description	Price /Each
58864	Needle Nozzle	\$11.99
58865	Coupler; Grease Gun, Standard	3.40
58866	Coupler; Grease Gun, Heavy Duty	6.76
58867	360° Grease Coupler	20.22
58868	12" Grease Hose w/ Spring Guard	13.13
58869	36" Grease Hose	26.69
58870	Nipple, 1/4" Linc, 1/4" MNPT	2.89
58871	1/4" Female NPT Coupler - 2 pack	9.33
58880	12" Grease Hose	7.67
58881	18" Grease Hose	12.72
58882	Grease Gun Filler Pump	70.42

Oil Cans



Part No.	Vendor No.	Description	Price /Each
0489563	719	4 Qt.	\$23.29
0489564	715	1 Qt.	16.29

Fill Can



Part No.	Vendor No.	Description	Price /Each
0489565	743	4 Qt.	\$60.69

Oil Drain Pans



3-1/2 Gallon Model



7 Gallon Model

Part No.	Vendor No.	Description	Price /Each
0489566	721	3-1/2 Gallons	\$11.37
0489567	723	7 Gallons	36.86

Funnels



14" Flex Model



1 Qt. Galvanized Model



5 Qt. Off Set Model

Part No.	Vendor No.	Description	Price /Each
0489568	86	14" Flex	\$10.89
0489569	701	1 Qt. Galvanized	8.09
0489570	705	5 Qt. Off Set	31.77

Hand Oilers With Rigid Spout

Corrosion resistant finish. Heavy duty steel bodies. Available in 6 oz., 12 oz., 16oz., and 1qt. sizes.



Part No.	Vendor No.	Description	Price /Each
0489610	G503	6 oz. Hand Oiler - Flex Spout	\$11.28
0489608	G504	12 oz. Hand Oiler - Flex Spout	13.23
0489609	G507	16 oz. Hand Oiler - Flex Spout	15.75
0400211	50-347	1 Quart Hand Oiler-Flex Spout	22.89

GREASE GUNS

Grease Guns

Industrial Lubricants
& Equipment



12V Cordless Grease Gun

Cordless grease gun with 12V hi-torque motor. Powered by 12V Ni-Cd battery.

Features

- 3' ultra flexible hose with 8000 PSI working pressure
- Industrial grease coupler
- Air bleeder valve
- One hour charger
- Optimized air flow to maximize motor cooling
- Heavy Duty carrying case



Part No.	Description	Price /Each
0401433	Single Battery Included	\$249.00
0401434	Two Batteries Included	299.99

Cordless Grease Gun Accessories

Part No.	Description	Price /Each
0401435	12V Battery Charger	\$49.25
0401436	12V Spare Battery	81.20
0401437	12V Carry Strap	10.90
0401440	12V Battery Car Charger	49.05



Rechargeable 12 volt cordless grease flow at up to 6000 PSI. Machined and hardened piston. Locking follower rod and accessible check valve. Uses standard 14 oz. grease cartridges or can be filled for bulk filler, optional nipple needed. Will dispense three 14 oz. tubes of grease on a single charge.



Part No.	Price /Each
0489611	\$259.75

Same as above part number 0489611, however this kit includes 2 batteries.

Part No.	Price /Each
0489612	\$319.50

Many Types of Greases Available on page 10-173.

The source for all your lubrication equipment needs

Grease guns, fitting, pumps, meters and much more. Alemite manufactures a complete line of lubrication and fluid handling products and systems. Our high-performance products are engineered with one goal in mind - to improve the efficiency of your lubrication operation.

BLACKSTONE™

Air Operated Grease Gun

Air operated grease gun that features ergonomic handle and cylinder design. Uses 14 oz. grease cartridge. Has 1/4" NPT air inlet with an input pressure of 60-100 PSI.



Part No.	Price /Each
58872	\$59.80

Mini Grease Gun

A compact "tool box" size grease gun perfect for hard-to-reach jobs. Ideal for do-it-yourself automotive, industrial, farm, and RV applications. Corrosion resistant finish.

For use with 3 oz. grease tubes Part No. 58885



Part No.	Price /Each
58873	\$23.39

Grease Guns Cont.

BLACKSTONE™

Heavy Duty Pistol Grip Grease Guns

Convenient one hand operation. Uses 14 oz. grease cartridge or can be bulk filled. Non-slip, knurling on a heavy duty steel barrel.



4" Rigid Model 18" Flexible Extension Model

Part No.	Description	Price /Each
58874	18" Flexible Extension Hose	\$26.96
58875	4" Rigid	26.19

Lever Action Grease Gun

Will accommodate any standard 14 oz. grease cartridge. Features include electrostatic corrosion resistant finish and non-slip knurling for better grip.



Part No.	Price /Each
58876	\$14.14

Heavy-Duty Industrial Lever Action Grease Gun

Made for the punishing day-in and day-out service required by industrial customers. Rugged, fully zinc plated finish. Dual port head cap with bulk loader fitting. Comes with 6" rigid extension and coupler. 14 oz. cartridge.



Part No.	Price /Each
58879	\$23.39

Suction Gun

A rugged tool designed for all-purpose draining and filling of clutches, differentials, and transmissions. Use with any type of non-corrosive lubricants. Needs no priming. 18 oz. capacity with 12" flexible hose.



Part No.	Price /Each
58883	\$15.95

LINCOLN®

Super Heavy Duty Pistol Grip Grease Gun

This grease gun features 3-way loading: cartridge, suction or bulk. The variable stroke design delivers both high pressure and high volume. Includes one gun with a heavy-duty 18" flexible hose with coupler and rigid 4" tube. (Lincoln part number is 1134.)



Part No.	Price /ea
0401781	\$47.86

Super Heavy Duty Lever Grease Guns

Jam-proof toggle mechanism prevents binding or accidental bending of plunger. Precision fit and hardened plunger prevents lubricant bypass, resists scoring for longer life. Rugged cast iron pump head for strength and durability. Delivers fast, dependable lubrication. Follower rod locks into follower to force prime. Exclusive "Flip-Over" follower allows a superior seal for either cartridge or bulk loading applications. Tough, resilient and impervious to lubricant; Extra-heavy follower spring insures positive priming and uninterrupted pumping action.



Part No.	Price /Each
0489615	\$29.50

Same as above part number 0489615, however this gun has an 18" whip hose extension. (Vendor # 1147)

Part No.	Price /Each
0489674	\$42.25

Heavy Duty Bucket Pump

Fits 25-50 lb. buckets. Includes pump, drum cover, and 4' delivery hose. Perfect for transferring transmission fluids or heavier fluids.



Part No.	Price /Each
58878	\$43.85

BLACKSTONE™

Heavy-Duty Barrel Pump

Fits 30-55 gallon drums. Pump delivers 10 ounces per stroke. Comes with standard bung bushing. Designed for efficient transfer of petroleum-based, non-corrosive fluids. Rugged, corrosive-resistant finish prevents rusting.



Part No.	Price /Each
58877	\$35.50

Grease

CONOCO

#2 Megaplex XD-5 Moly Gray Lithium Complex Grease

- Suitable for use in heavy equipment
- Meets caterpillar and Terex requirements for 5% moly grease
- 14 oz cartridge



Part No.	Vendor No.	Description	Qty.	Price /Ea
0411137	1044178	MEGAPLEX XD-5 #2	14 oz Tube	\$6.49

CRC

E-P Moly-Graph® Multi-Purpose Lithium Grease

The best general-purpose grease for a wide range of industrial applications. Added "moly" and graphite establish fine micron plating on all working surfaces. Use on bushings, slides, and U-joints.



Part No.	Description	Price /Each
63295	14 oz. Cartridge	\$5.95
63292	14 oz. Can	\$6.15
63293	35 lb. Pail	129.54:
63294	7 lb. Pail	37.39

Super White™ Multi-Purpose Grease

A stable, water-resistant lithium base grease with white lubricating solids designed to meet NLGI #1.5 grade specs. Use for ball and roller bearings, sleeves, bushings and brake parts.



Part No.	Description	Price /Each
63296	14 oz. Cartridge	\$6.34
63297	14 oz. Can	7.08
63298	35 lb. Pail	143.94:

Lithium General Purpose Grease

A versatile, lithium base grease designed for light-duty applications requiring long grease life. Will not break down or run out. Use with bushings, slides, cables, and motor bearings.



Part No.	Description	Price /Each
63308	14 oz Cartridge	\$5.85
63309	14 oz. Can	4.91
63310	35 lb. Pail	103.42:

GREASE & INDUSTRIAL LUBRICANTS

Grease Cont.



Constant Velocity (C.V.) Joint Grease

Extremely stable lithium base grease fortified with Molybdenum disulfide which greatly extends the life of CV Joints. Will not attack or run out of C.V. boot. Protects against rust and corrosion.



Part No.	Description	Price /Each
63304	4 oz. Tube	\$5.51



#2 Dynalife GC-LB Red Lithium Multi Complex Grease

- Suitable for wheel bearings in cars, trucks, and buses
- Contains an EP additive and tackifier
- 14 oz cartridge



Vendor Part No.	Vendor No.	Description	Qty.	Price /Ea
0411136	1044158	DYNALIFE GC-LB#2	14 oz Tube	\$4.89



Sta-Plex® Premium Red Grease

A superior multi-purpose, NLGI #2 Certified lithium complex grease known for its versatility and high-temperature lubrication. Use on equipment exposed to severe operational conditions.



Part No.	Description	Price /Each
63306	14 oz. Cartridge	\$7.96
63307	35 lb. Pail	236.57:

Ball and Roller Bearing Hi-Temp Grease

Specially-treated petroleum base stocks, rust and oxidation inhibitors and extreme pressures additives with an aluminum complex thickener. Use for heavy-loaded bushings. 14 oz. cartridge.



Part No.	Price /Each
63313	\$7.14

Hi-Temp Disc Brake Wheel Bearing Grease

A very stable, aluminum complex grease made from highly refined base oils, with rust and oxidation inhibitors. Extends the parts' life and reduces down-time. Use on farm and transportation equipment.



Part No.	Description	Price /Each
63300	14 oz. Cartridge	\$6.54
63301	14 oz. Can	6.87
63303	7 lb. Pail	41.81
63302	35 lb. Pail	98.76:



#2 Omniguard Tan/Brown Calcium Complex Grease

- Multi-Purpose EP Grease
- Suitable for high temperatures, corrosive environments and exposure to water
- 14 oz cartridge



Vendor Part No.	Vendor No.	Description	Qty.	Price /Ea
0411135	1044208	OMNIGUARD #2	14 oz Tube	\$6.89



Boat Trailer Wheel Bearing Grease

A distinctive blue, tacky grease with natural water resistance. Resists washout under the most severe water conditions. For marine use, including trailer wheel bearings, steering quadrants, blocks, and slides.



Part No.	Description	Price /Each
63286	14 oz. Cartridge	\$6.09
63287	14 oz. Can	7.31
63288	35 lb. Pail	105.27:

Permatherm™ High Temperature Synthetic Grease

A high-performance synthetic grease with a non-melting thickener. Exceptional anti-wear properties at temperatures up to 600°F. Use on fan and oven bearings and paper-machine dryers. 14 oz. cartridge.



Part No.	Description	Price /Each
63312	14 oz. Cartridge	\$24.34

Heavy Duty Drum Brake Wheel Bearing Grease

Sodium-based grease for autos and trucks with drum brake systems and slow-speed industrial bearings. Economical, fibrous, and heat resistant grease with good adhesiveness.



Part No.	Description	Price /Each
63289	14 oz. Can	\$4.99
63291	7 lb. Pail	23.24
63290	35 lb. Pail	88.28:



Marine and Trailer Wheel Bearing Grease

A high quality calcium sulfonate based, multi-purpose grease that performs well under a temperature range of 0° to 550°F. Highly water insoluble and washout resistant. Fully fortified with additives to protect against rust, oxidation, extreme pressure, and wear. A recommended leader for medium slow to medium high speed bearings and greased chassis points. NLGI Grade 2. USDA H2. 3 oz. cartridge with 2 per blister card. 3 oz cartridges for use with Fastenal part # 58873 (mini grease gun)



Part No.	Price /Each
58885	\$10.49

Miscellaneous Industrial Lubricants



Hydraulic Fluid 5 Gallon Pail Long Life Hydraulic Fluid

- High quality antiwear hydraulic oil
- Excellent oxidation stability and water separation
- Long oxidation life



Part No.	Vendor No.	Description	Price /Ea
0411095	1040359	32-5 GAL PAIL	\$83.79
0411096	1040370	68-5 GAL PAIL	83.79

5 Gallon Pail High Dielectric Strength Hydraulic Fluid MV32

- High viscosity index
- Excellent low and high temperature performance
- Long oxidation life



Part No.	Vendor No.	Description	Price /Ea
0411097	1040352	MV32-5 GAL PAIL	\$90.49

Miscellaneous Industrial Lubricants Cont.



CONOCO Ecoterra® Hydraulic Fluid 32

- Outstanding oxidation stability
- Environmentally friendly, zinc free
- Inherently biodegradable



Part No.	Vendor No.	Description	Size	Price /Ea
0411098	1040839	Ecoterra Hydraulic Fluid 32	5 Gal.	\$99.19

Multi-Way Machine Lubricant

- Excellent control of lubricant run-off, excellent stick/slip prevention
- Tested and approved by Bijur and Cincinnati Machine



Part No.	Vendor No.	Description	Size	Price /Ea
0411105	9111000	Multi-way Lubricant 68	5 Gal.	\$102.79
0411106	9116000	Multi-way Lubricant 220	5 Gal.	103.89

Gear Oil

- Extreme-pressure gear oil that resists foaming and has long service life
- Long oxidation life.



Part No.	Vendor No.	Description	Size	Price /Ea
0411107	1040309	Gear Oil 220	5 Gal.	\$106.59
0411108	1040580	Gear Oil 460	5 Gal.	106.59



Gear Oil Bottle

- APR/GL-4 Multipurpose gear oil
- Low pour point and high temperature properties to provide lubrication over a wide temperature range
- Contains anti-rust and anti-wear EP additives to provide corrosion protection in drives and hoid gears



Part No.	Description	Size	Price
0604162	85W90 Gear Oil	32 oz.	\$6.42

Hydraulic & Jack Oil

- Medium weight hydraulic oil for use in Hydraulic systems and fluid drive units
- Blended using a high quality paraffinic base oil with anti-rust, anti-oxidation, anti-foam, anti-wear and seal swell additives
- May be added to existing fluids
- Not for use in hydraulic brakes



Part No.	Size	Price /Each
63339	1 Quart Bottle	\$7.92
63340	1 Gallon Bottle	24.23



Powertran Fluid

- Multifunctional fluid for transmission, final drive, wet brakes, and hydraulic systems



Part No.	Vendor No.	Size	Price /Ea
0411109	1040631	5 Gal. Pail	\$99.19



CatOil Compressor and Air Tool Lubricant

CatOil Compressor & Air Tool Lubricant is the only non-foaming lubricant that conditions and protects gaskets, seals, o-rings and metal. It's anti-friction, anti corrosive properties will:

CatOil Compressor & Air Tool Lubricant will not build up and create a residue that will attract airborne contaminant's. It also protects your compressors and air tools against condensation. Even in extremely cold weather anti-freeze is not necessary. Use CatOil Compressor & Air Tool Lubricant according to your compressor and air tool manufacturers' instructions.

- Decreases Operating Temperatures
- Decreases Fuel/power Consumption
- Decreases Maintenance and Repair Costs



Part No.	Size	Price /Each
0286070	4 oz.	\$6.29
0286031	1 qt.	24.95
0286125	1 gallon	74.95
0286545	5 gallons	299.00



Air Tool Oil

A special lubricant designed for pneumatic tools. Protects against rust and corrosive attack from water and corrosive materials contained in compressed air. **Use for pneumatic wrenches, drills, hammers, saws and grinders.**



Part No.	Description	Price /Each
63341	15 oz. Bottle	\$6.46



Kendall Synthetic Blend Motor Oil

- Premium-quality, part-synthetic motor oil for passenger cars, vans, light trucks, and SUVs.
- Meets or exceeds APR Service SM
- Energy Conserving for improved fuel economy



Part No.	Vendor No.	Description	Pkg. Qty.	Price /Qt.
0411145	1042939	5W20 Motor Oil	12 Qts	\$4.79
0411146	1042954	5W30 Motor Oil	12 Qts	4.69
0411147	1042106	10W30 Motor Oil	12 Qts	4.65

Kendall Super-D3 Diesel Engine Oil

- Premium-quality universal fleet engine oil for on- and off-highway diesel equipment.
- Can also be used in passenger cars and light trucks
- Meets or exceeds APR CI-4 Plus
- Outstanding soot control
- SAE15W-40 Engine Oil



Part No.	Vendor No.	Pkg. Qty.	Price /Gal.
0411148	1043442	6 Gals	\$17.99



Universal 2 Cycle Oil

- Specially formulated for air cooled and small horsepower engines
- Produces minimal smoke
- Protects against rust and high heat
- Minimizes plug fouling, port plugging, ring stretching, carbon deposits, and piston seizure



Part No.	Size	Price /Each
0123323	8 oz Bottle	\$3.70
0123324	15 oz Bottle	\$6.99

OIL AND GREASE PUMPS

Oil and Grease Pumps



Air Operated Oil Pumps

- For use with a variety of different oils (gear, hydraulic, machine, cutting, etc.)
- Easy maintenance, constructed with 50% fewer parts than most comparable pumps
- Reliable operation, backed by five year warranty
- Low noise, only 80-dbs (2"), 85-dbs (3")
- Bung adaptor included
- Stub style pump - Female threaded inlet allows pump to be mounted independent of source tank



Air Motor Size	Pump Ratio	Cont. Size	Max. Flow GPM	Out Pressure Max. PSI	Air Inlet NPT(F)	Fluid Inlet /Outlet NPTF	Vendor No.	Ship Wt. (lbs)	Part No.	Price /Each
3.0	5.1	Stub	6	500	1/4	11/2 -1/2	LM2305A-11	16	0470136	\$899.00
3.0	5.1	16 Gallon	6	500	1/4	11/2 -1/2	LM2305A-31	29	0470137	949.00
3.0	5.1	55 Gallon	6	500	1/4	11/2 -1/2	LM2305A-41	29	0470138	999.00

Gear Oil Pump Package with Meter

Includes: Pump, pint/gallon meter, control handle, drum cover, six feet of hose and roller dolly. Container not included.



Air Motor Size	Pump Ratio	Cont. Size	Max. Flow GPM	Out Pressure Max. PSI	Air Inlet NPT(F)	Fluid Inlet /Outlet NPTF	Vendor No.	Ship Wt. (lbs)	Part No.	Price /Each
2.0	3:1	16 Gallon	6	500	1/4	3/4-1/2	LP2100-1	37	0470142	\$1195.50

Grease Pump Packages

- Part numbers **0470139** and **0470140** include: pump, follower plate, drum cover, air coupler/connector, six foot hose, and high-pressure gun. Part number **0470141** lacks the gun and follower plate
- Perfect for all multi-purpose greases
- Easy installation
- Reliable operation, backed by industry leading five year warranty
- Low noise, only 80-dbs (2"), 85-dbs (3")
- Roller dolly included with 0470140



0470139 0470141

Air Motor Size	Size	Max. Lbs. /Min.	Pump Ratio	Vendor No.	Ship Wt. (lbs)	Part No.	Price /Each
2.0	5 Gal./35 lb.	9.0	50:1	LP2002-1-B	24.0	0470139	\$1064.41
2.0	16 Gal./120 lb.	9.	50:1	LP2006-1-B	37.0	0470140	1251.87
3.0	55 Gal./400 lb.	7.5	50:1	LP3005-1	53.0	0470141	1323.55

Metallic Air Operated Diaphragm Pumps

- Self-priming
- No-stall air motor design
- All bolted construction-no leaks
- Quick dump exhaust valve eliminates air motor icing
- Wide variety of housing and diaphragm materials
- Made in the USA
- Manufactured to ISO 9001 Quality Standards



0470127 thru 0470131



0470122 thru 0470125



0400020 thru 0400022

GPM Flow Typical	Max. Flow GPM	Max. CFM	Max. Pressure	Pump Body Material	Diaphragm Material	Air Inlet NPT	Inlet /Outlet FNPT	Susp. Solids Max. Dia.	Weight	Vendor No.	Part No.	Price /Each
13	13	20	100	Aluminum	Nitrile	1/4	1/2"	3/32	8.4	PD05P-AAS-PGG	0470122	\$570.52
13	13	20	100	Aluminum	Teflon	1/4	1/2"	3/32	8.4	PD05P-AAS-STT	0470123	856.45
13	13	20	100	Stain. Steel	Teflon	1/4	1/2"	3/32	14.6	PD05P-ASS-STT	0470125	1290.18
35	35	40	120	Stain. Steel	Teflon	1/4	1"	1/8	36	666101-344-C	0470129	1739.85
35	35	40	120	Aluminum	Nitrile	1/4	1"	1/8	19	666100-322-C	0470127	722.50
35	35	40	120	Aluminum	Teflon	1/4	1"	1/8	19	666100-344-C	0470128	1025.00
85	90	112	122	Aluminum	Teflon	1/2	1-1/2"	1/4	51	66615A-244-C	0400016	1655.00
85	90	112	123	Stainless	Teflon	1/2	1-1/2"	1/4	84	66615B-244-C	0400018	3159.00
100	100	110	120	Aluminum	Nitrile	1/2	1-1/2"	1/4	51	666150-322-C	0470131	974.08
125	170	125	124	Aluminum	Teflon	3/4	2"	1/4	64	PD20A-AAS-STT	0400020	1969.75
125	170	125	125	Stainless	Teflon	3/4	2"	1/4	188	PD20C-ASS-STT	0400022	4975.00

Oil and Grease Pumps Cont.



Non-Metallic Air Operated Diaphragm Pumps

Polypropylene pumps offer wide material compatibility (acids, alkalis, stabilizers, aliphatic substances, etc.), high fatigue endurance, and superior abrasion resistance. Flow rate depends on air pressure and fluid viscosity. Maximum flow rates are achieved at 100 PSI for 1/2" pumps and 120 PSI for others. Verify materials of construction with Chemical Resistance Chart listed in the pump section.

- Self-priming (15 ft. wet; 10 ft. dry)
- No-Stall Motor Design
- Maximum Temperature: 150°F



0470113



0470117 thru 0470121



0400012

Max. Flow GPM	Max. CFM	Operating Pressure (PSI)	Pump Body Material	Diaphragm Material	Air Inlet NPT	Inlet /Outlet FNPT	Description	Susp. Solids Max. Dia.	Weight	Part No.	Price /Each
4.6	100	100	Polypropylene	Teflon	1/4	3/8 -1/4	Threaded	1/32	4.1	0470113	\$349.90
13	100	100	Polypropylene	Teflon	1/2	1/2	Threaded	3/32	7.2	0470117	662.40
90	120	100	Polypropylene	Santoprene	1/2	1/2	Threaded	3/32	7.2	0470118	499.00
47	100	100	Polypropylene	Teflon	1	1	Flange	1/8	20.2	0470121	1325.00
100	128	120	Polypropylene	Teflon	1/2	1-1/2	Flange	1/4	108	0400012	2635.00

Diaphragm Drum Packages

- **Includes:** Pump, Bung Adapter, Air Shut-Off, Siphon Tube, Weather Seal, and Base
- Available in polypropylene, aluminum, and stainless steel
- Steel body materials for optimum compatibility
- Stall-free operation
- Bolted construction
- 5-year warranty



GPM	Body Material	Seat	Ball/Diaphragm Material	Fluid Service	Air Inlet NPT	Vendor No.	Part No.	Weight	Price /Each
11	Polypropylene	Polypropylene	Teflon	Mild Acid	1/4	DA005-PPTT-2-A	0470132	8.2	\$785.50
11	Aluminum	Polypropylene	Polypropylene	Oil	1/4	DA005-APNN-2-A	0470133	8.2	749.00
11	Stain. Steel	Stain. Steel	Teflon	Solvent	1/4	DA005-SSTT-2-A	0470135	17	1499.00

Waste Oil Pump Package

Includes: 1" Diaphragm pump, wall mount bracket, 1" pump inlet/outlet hose assembly, airline filter/regulator, 1/4" air inlet hose, and fluid coupler.



GPM	Max. Flow GPM	Max. Flow CFM	Fluid Inlet /Outlet	Vendor No.	Ship Wt. (lbs)	Part No.	Price /Each
17	35	40	1"	612999-4	30	0470143	\$1325.00

Meters

PRESET METER: Automatically shuts off when set quantity of fluids is delivered and meter indicator returns to zero. Totalizer registers to 9,999. **Part Number 0470144.**

ELECTRONIC METER: Designed for precise reliable measurements (pints and gallons). Fast reset, precise, totalizes, and is lightweight. **Part Number 0470145.**



0470144



0470145

Max. Flow GPM	Operating Pressure (PSI)	Fluid Inlet NPTF	Fluid Outlet	Vendor No.	Ship Wt. (lbs)	Part No.	Price /Each
4	1000	1/2	1/2 Non-Drip Tip	635390-2	5.0	0470144	\$589.00
4	1000	1/2	1/2 Non-Drip Tip	635364	6.8	0470145	925.00

LUBE METERS AND THERMOPLASTIC D.O.T TUBING

Lube Meters



Electronic Lube Meters

- **Flow Range:** 0.25 gpm to 6.0 gpm
- **Operating Pressure Range:** 5 to 1500 PSI
- **Operating Temperature Range:** -10 to +110° F
- **Accuracy:** +/- .05%

These meters are designed specifically to dispense typical fluids such as motor oils, gear oils, automatic transmission fluids, and pure antifreeze. Features include: accuracy, field replaceable batteries with low battery indicator, shock resistant housings and more.



Part No.	Price /ea
0401782	\$545.00

Nozzle & tip configuration is a flex straight hose with automatic tip.



Part No.	Price /ea
0401783	\$499.00

Nozzle & tip configuration is a 30° rigid spout with automatic tip.

Thermoplastic D.O.T. Tubing



NT100 Nylon 11

SAE J844 Type A & B DOT FMVSS 571.106

- **Typical Application:** Air brake systems except where temperatures exceed +200°F or where battery acid can drip on tubing.
- **Construction:** Core= NYLON; Braid= POLYAMIDE FIBER (3/8" and larger sizes only); Jacket=NYLON.
- **Temperature Range:** -40°F to +200°F (-40°C to +93°C)
- **Available Colors:** White, black, yellow, orange, blue, red, green, gray. Refer to current price list for availability of colors.
- **Contains:** Ultra-Violet stabilizer in all colors.
- **Note:** 3/16", 1/4" and 5/16" are SAE J844 Type A (not reinforced); 3/8", 1/2", 5/8" and 3/4" are SAE J844 Type B (reinforced).

Part No.	Tube O.D.	Tube Wall	Max. Work Pressure		Min. Burst Pressure	Min. Bend Radius	Lbs./100 ft.	Coil Lgth.
			PSI 70°F	PSI 70°F				
NT10002	**1/8 (.125)	.023	150	1000	1000	.375"	.4	100,500,* 1000
NT10004	1/4 (.250)	.040	150	1200	1200	1.0"	1.2	100,500,* 1000
NT10005	5/16 (.312)	.040	150	1000	1000	1.25"	1.8	100,500,* 1000
NT10006	3/8 (.375)	.062	150	1400	1400	1.5"	2.9	100,500,* 1000
NT10008	1/2 (.500)	.062	150	950	950	2.0"	3.8	100,500,* 1000
NT10010	5/8 (.625)	.092	150	900	900	2.5"	6.8	100, 250
NT10012	3/4 (.750)	.092	150	800	800	3.0"	8.4	100, 250

Tube O.D. - 1/8

Part No.	Color	Vendor No.	Coil Lgth.	Price /Ft
450013-131280	Black	NT10002	100	\$0.26
450014-131280	BK	NT10002	500	0.18

**1/8" NT1002 tubing does not meet DOT standards

Tube O.D. - 3/16

Part No.	Color	Vendor No.	Coil Lgth.	Price /Ft
0450501	BK	NT10003	*1000	\$0.48

Tube O.D. - 1/4

Part No.	Color	Vendor No.	Coil Lgth.	Price /Ft
450016-131280	Black	NT10004	100	\$0.50
0450183	Red	NT10004	100	0.50
0450184	Blue	NT10004	100	0.50
0450185	GN	NT10004	100	0.50
0450186	YW	NT10004	100	0.50
0450187	OR	NT10004	100	0.50
0450188	WH	NT10004	100	0.51
0450192	BR	NT10004	100	0.50
450017-131280	BK	NT10004	500	0.42
0450191	BU	NT10004	500	0.42
0450195	WH	NT10004	500	0.42
450018-131280	BK	NT10004	*1000	0.41
0450197	RD	NT10004	*1000	0.41
0450502	WH	NT10004	*1000	0.41

Tube O.D. - 5/16

Part No.	Color	Vendor No.	Coil Lgth.	Price /Ft
450019-131280	Black	NT10005	100	\$0.49
450020-131280	BK	NT10005	500	0.43
450021-131280	BK	NT10005	*1000	0.41

Tube O.D. - 3/8

Part No.	Color	Vendor No.	Coil Lgth.	Price /Ft
450022-131280	Black	NT10006	100	\$1.24
0450521	Red	NT10006	100	1.24
0450522	Blue	NT10006	100	1.24
0450523	GN	NT10006	100	1.24
0450524	YW	NT10006	100	1.24
0450525	OR	NT10006	100	1.24
0450526	WH	NT10006	100	1.24
450023-131280	BK	NT10006	500	1.05
0450527	RD	NT10006	500	1.05
0450528	BU	NT10006	500	1.05
0450529	GN	NT10006	500	1.05
0450531	OR	NT10006	500	1.05
0450532	WH	NT10006	500	1.05
450024-131280	BK	NT10006	*1000	0.99

Tube O.D. - 1/2

Part No.	Color	Vendor No.	Coil Lgth.	Price /Ft
450025-131280	Black	NT10008	100	\$1.70
0450539	Red	NT10008	100	1.70
0450540	Blue	NT10008	100	1.70
0450541	GN	NT10008	100	1.70
0450543	OR	NT10008	100	1.70
0450544	WH	NT10008	100	1.70
450026-131280	BK	NT10008	500	1.33
0450545	RD	NT10008	500	1.33
0450546	BU	NT10008	500	1.33
0450547	GN	NT10008	500	1.33
450027-131280	BK	NT10008	*1000	1.30

Tube O.D. - 5/8

Part No.	Color	Vendor No.	Coil Lgth.	Price /Ft
450028-131280	Black	NT10010	100	\$1.95
0450557	Red	NT10010	100	1.95
0450558	Blue	NT10010	100	1.95
0450559	GN	NT10010	100	1.95
0450562	WH	NT10010	100	1.95
450029-131280	BK	NT10010	*250	1.88
0450568	WH	NT10010	*250	1.88

Tube O.D. - 3/4

Part No.	Color	Vendor No.	Coil Lgth.	Price /Ft
450030-131280	Black	NT10012	100	\$2.63
450031-131280	BK	NT10012	*250	2.47

DOT PUSH-TO CONNECT FITTINGS

DOT Push-to-Connect Fittings



Specifications:

- Body: Nylon 6.6
- Seal: Low Temp Nitrile
- Pressure: 275psi, 28"HG
- Temp Range: -20°F to 225°F
- Tube Support: Brass
- Meet all applicable requirements of the D.O.T. FMVSS 106 specification.
- Designed for use on all pneumatic circuits other than air brake assemblies between the frame and the axle or between towed and towing vehicle.
- Use in conjunction with D.O.T. rated tubing.



DOT Union Elbow

Part No.	Vendor No.	Tube O.D.	Pkg. Qty.	Price
0451632	3102 04 00DOT	5/32	10	\$3.92
0451576	3102 56 00DOT	1/4	10	4.48
0451612	3102 60 00DOT	3/8	10	8.31
0451563	3102 62 00DOT	1/2	10	9.35

DOT Union Tee



Part No.	Vendor No.	Tube O.D.	Pkg. Qty.	Price
0451627	3104 04 00DOT	5/32	10	\$5.22
0451575	3104 56 00DOT	1/4	10	5.88
0451611	3104 60 00DOT	3/8	10	8.48
0451562	3104 62 00DOT	1/2	10	13.56

DOT Straight Union



Part No.	Vendor No.	Tube O.D.	Pkg. Qty.	Price
0451628	3106 04 00DOT	5/32	10	\$3.47
0451606	3106 55 00DOT	3/16	10	5.43
0451577	3106 56 00DOT	1/4	10	3.86
0451613	3106 60 00DOT	3/8	10	6.32
0451564	3106 62 00DOT	1/2	10	10.34

DOT Male Branch Tee

- Nickel plated brass base with nylon body



Part No.	Vendor No.	Tube O.D.	NPT Size	Pkg. Qty.	Price
0451633	3108 04 14DOT	5/32/4 mm	1/4	10	\$9.88
0451584	3108 56 11DOT	1/4	1/8	10	5.76
0451578	3108 56 14DOT	1/4	1/4	10	6.13
0451589	3108 56 18DOT	1/4	3/8	10	11.05
0451617	3108 60 14DOT	3/8	1/4	10	10.05
0451621	3108 60 18DOT	3/8	3/8	10	11.22
0451614	3108 60 22DOT	3/8	1/2	10	12.96
0451565	3108 62 22DOT	1/2	1/2	10	15.91

DOT Male Elbow

- Nickel plated brass base with nylon body



Part No.	Vendor No.	Tube O.D.	NPT Size	Pkg. Qty.	Price
0451629	3109 04 11DOT	5/32	1/8	10	\$4.86
0451585	3109 56 11DOT	1/4	1/8	10	3.86
0451579	3109 56 14DOT	1/4	1/4	10	4.34
0451590	3109 56 18DOT	1/4	3/8	10	10.82
0451618	3109 60 14DOT	3/8	1/4	10	9.86
0451622	3109 60 18DOT	3/8	3/8	10	10.49
0451615	3109 60 22DOT	3/8	1/2	10	10.82
0451569	3109 62 14DOT	1/2	1/4	10	11.50
0451572	3109 62 18DOT	1/2	3/8	10	11.53
0451566	3109 62 22DOT	1/2	1/2	10	11.67

DOT Straight Female Connector

- Nickel Plated Brass



Part No.	Vendor No.	Tube O.D.	NPT Size	Pkg. Qty.	Price
0400284	3114 04 14DOT	5/32	1/4	10	\$6.62
0400285	3114 55 11DOT	3/16	1/8	10	5.13
0400286	3114 56 11DOT	1/4	1/8	10	4.23
0400287	3114 56 14DOT	1/4	1/4	10	5.44
0400288	3114 60 14DOT	3/8	1/4	10	8.62
0400289	3114 60 18DOT	3/8	3/8	10	8.75

DOT Bulkhead Union



Part No.	Vendor No.	Tube O.D.	Pkg. Qty.	Price
0400305	3116 56 00DOT	1/4	10	\$5.46
0451610	3116 60 00DOT	3/8	10	9.91

DOT Male Connector

- Nickel Plated Brass



Part No.	Vendor No.	Tube O.D.	NPT Size	Pkg. Qty.	Price
0400290	3115 04 11DOT	5/32	1/8	10	\$2.31
0400291	3115 04 14DOT	5/32	1/4	10	3.81
0400292	3115 55 11DOT	3/16	1/8	10	3.08
0400293	3115 55 14DOT	3/16	1/4	10	4.69
0400294	3115 56 11DOT	1/4	1/8	10	2.94
0400295	3115 56 14DOT	1/4	1/4	10	2.94
0400296	3115 56 18DOT	1/4	3/8	10	3.90
0400297	3115 60 11DOT	3/8	1/8	10	5.64
0400298	3115 60 14DOT	3/8	1/4	10	4.16
0400299	3115 60 18DOT	3/8	3/8	10	5.19
0400300	3115 60 22DOT	3/8	1/2	10	7.69
0400301	3115 62 14DOT	1/2	1/4	10	7.07
0400302	3115 62 18DOT	1/2	3/8	10	7.26
0400303	3115 62 22DOT	1/2	1/2	10	7.40

DOT PUSH-TO-CONNECT FITTINGS

DOT Push-to-Connect Fittings Cont.

Hydraulic/Pneumatic Fleet



DOT Union "Y"

- Nylon Body
- Tube to Tube



Part No.	Vendor No.	Tube O.D. x Tube O.D.	Pkg. Qty.	Price
0451640	3140 04 00DOT	5/32/4 mm x 5/32/4 mm	10	\$5.22
0451582	3140 56 00DOT	1/4 x 1/4	10	5.88
0451625	3140 60 00DOT	3/8 x 3/8	10	10.62

DOT Plug-In Elbow

- Nylon Body



Part No.	Vendor No.	O.D.	Pkg. Qty.	Price
0400323	3182 56 00DOT	1/4	10	\$1.88

DOT Plug-In Union Tee

- Nylon Body



Part No.	Vendor No.	O.D.	Pkg. Qty.	Price
0400325	3188 56 00DOT	1/4	10	\$4.94

DOT Tubing

- Ideal for use in transportation and instrumentation markets and pneumatic accessories
- Designed to replace rubber and metal tubing
- Offers superior resistance to oil, grease, gasoline, fuel, salts, moisture and chemicals



Part No.	Vendor No.	Color	I.D.	Tube O.D.	Pkg. Qty.	Price /Roll
0431199	1094P04 01DT	Black	.124	5/32	100	\$37.90
0431201	1094P56 01DT	Black	.210	1/4	100	55.72
0431202	1094P60 01DT	Black	.313	3/18	100	120.71
0431203	1094P62 01DT	Black	.438	1/2	100	172.94

DOT Quick Repair Kit



Part No.	Vendor No.	Description	O.D.	Pkg. Qty.	Price
0400316	3150 00 06 69	DOT Quick Repair Kit		1	\$50.25

Contains the following DOT fittings:

Description	Part No.	Qty.
1/4NPT x 1/8NPT Brass Female to Male Expander	0451681	1
3/8NPT x 1/4NPT Brass Female to Male Expander	0451712	1
3/8ODx3/8NPT DOT Nickel plated Brass Male Elbow P-T-C	0451622	1
1/4"ODx1/4"NPT DOT Male Elbow Nylon Push-to-Connect	0400275	1
3/8OD DOT Nylon Body Straight Union P-T-C	0451613	2
1/4" Tube OD DOT Union Nylon Push-to-Connect	0400257	2
1/4"OD x 3/8"OD DOT Tube Reducer P-T-C	0400320	2
Tube Cutter	-	1

Large DOT Fitting Kit



Part No.	Vendor No.	Description	O.D.	Pkg. Qty.	Price
0400315	3150 00 06 68	DOT Large Fit Kit		1	\$250.13

Description	Part No.	Qty.
3/8"OD x 1/4"NPT DOT Male Connector PTC	0400298	2
3/8"ODx 3/8"NPT DOT Male Connector PTC	0400299	2
1/4"ODx 3/8"NPT DOT Male Connector PTC	0400296	2
1/4"OD x 1/4"NPT DOT Male Connector PTC	0400295	2
1/4"OD x 1/8"NPT DOT Male Connector PTC	0400294	2
1/2"OD x 3/8"NPT DOT Male Connector PTC	0400302	2
1/2"OD x 1/4"NPT DOT Male Connector PTC	0400301	2
3/8OD DOT Nylon Body Union Tee P-T-C	0451611	2
1/4" Tube OD DOT Union Tee Nylon Push-to-Connect	0400252	2
1/4OD x 1/8NPT DOT NkIPtd Brass Male Branch Tee P-T-C	0451584	2
1/2OD DOT Nylon Body Straight Union P-T-C	0451564	2
3/8OD DOT Nylon Body Straight Union P-T-C	0451613	2
1/4" Tube OD DOT Union Nylon Push-to-Connect	0400257	2
1/4OD DOT Nylon Body Tube to Tube Bulkhead Union P-T-C	0400305	2
3/8OD DOT Nylon Body Elbow Union	0451612	2
1/4" Tube OD DOT Union Elbow Nylon Push-to-Connect	0400235	2
1/4"ODx3/8"NPT DOT Male Elbow Nylon Push-to-Connect	0400276	2
1/4"ODx1/4"NPT DOT Male Elbow Nylon Push-to-Connect	0400275	2
1/4"ODx1/8"NPT DOT Male Elbow Nylon Push-to-Connect	0400274	2
1/2ODx3/8NPT DOT NkIPtd Brass Male Elbow P-T-C	0451572	2
3/8ODx3/8NPT DOT NkIPtd Brass Male Elbow P-T-C	0451622	2
3/8ODx1/4NPT DOT NkIPtd Brass Male Elbow P-T-C	0451618	2

Quick Connect Air Brake®



Plugs, Pressure (Nylon)

Quick Connect Air Brake® fittings used with NT100 Nylon Tubing - SAEJ844. Meets DOT FMVSS 571.106 and SAE J1131 air brake system performance requirements.

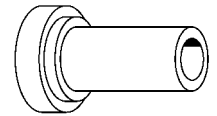

Tube O.D.	Part No.	Price /Each
1/4	0441574	\$0.72
3/8	0441575	1.01
1/2	0441576	1.05

Encapsulated Cartridge

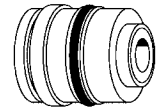

Tube O.D.	Part No.	Price /Each
1/4	0441579	\$4.48
3/8	0441580	4.98
1/2	0441581	5.96
5/8	0441582	9.15

Union

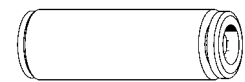

Tube O.D.	Part No.	Price /Each
5/32	0441584	\$7.34
1/4	0441585	8.47
3/8	0441586	9.64
1/2	0441587	11.72
5/8	0441588	15.90

Quick Connect Air Brake® Cont.

EATON | Weatherhead

Union Tee

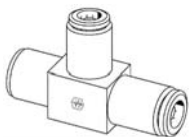

Tube O.D.	Part No.	Price /Each
1/4	0441589	\$12.52
3/8	0441590	15.16
1/2	0441591	17.92

Union Elbow

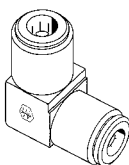

Tube O.D.	Part No.	Price /Each
1/4	0441592	\$8.43
3/8	0441593	11.27
1/2	0441594	15.98

Female Connector

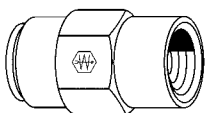

Tube O.D.	FPT	Part No.	Price /Each
1/4	1/8	0441595	\$7.15
1/4	1/4	0441596	7.42
3/8	1/4	0441597	7.55
3/8	1/8	0441598	11.72
3/8	3/8	0441599	7.63
1/2	1/4	0441601	9.43
1/2	1/2	0441602	12.65

Male Connector



Tube O.D.	MPT	Part No.	Price /Each
5/32	1/8	0441603	\$3.64
5/32	1/16	0441604	3.95
3/16	1/8	0441605	5.00
1/4	1/8	0441606	3.40
1/4	1/4	0441607	5.27
1/4	3/8	0441608	6.60
3/8	1/8	0441609	12.32
3/8	1/4	0441610	6.80
3/8	3/8	0441611	8.90
3/8	1/2	0441612	9.07
1/2	1/4	0441613	9.47
1/2	3/8	0441614	11.25
1/2	1/2	0441615	14.44
5/8	3/8	0441616	11.83
5/8	1/2	0441617	11.48
3/4	1/2	0441618	15.74

Male Elbow 90°



Tube O.D.	MPT	Part No.	Price /Each
5/32	1/8	0441619	\$5.15
5/32	1/16	0441620	5.25
3/16	1/8	0441621	5.63
1/4	1/8	0441622	5.91
1/4	1/4	0441624	6.44
1/4	3/8	0441626	7.62
3/8	1/4	0441628	8.79
3/8	1/8	0441630	9.58
3/8	3/8	0441632	9.16
3/8	1/2	0441634	11.47
1/2	3/8	0441636	13.15
1/2	1/4	0441638	14.39
1/2	1/2	0441640	13.33
5/8	1/2	0441642	15.36
5/8	3/8	0441644	13.90

Swivel Male Elbow 90°

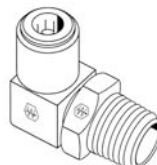

Tube O.D.	MPT	Part No.	Price /Each
1/4	1/8	0441623	\$8.04
1/4	1/4	0441625	8.76
1/4	3/8	0441627	10.17
3/8	1/4	0441629	11.38
3/8	1/8	0441631	12.28
3/8	3/8	0441633	11.83
3/8	1/2	0441635	13.48
1/2	3/8	0441637	15.67
1/2	1/4	0441639	16.00
1/2	1/2	0441641	17.75
5/8	1/2	0441643	18.25
5/8	3/8	0441645	18.45

Female Elbow



Tube O.D.	FPT	Part No.	Price /Each
1/4	1/8	0441646	\$7.31
1/4	1/4	0441647	10.60
3/8	1/4	0441648	10.73
3/8	1/8	0441649	16.13
3/8	3/8	0441650	12.09
1/2	3/8	0441651	13.04
1/2	1/4	0441652	13.28
1/2	1/2	0441653	13.90

Male Run Tee

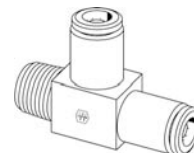

Tube O.D.	MPT	Part No.	Price /Each
1/4	1/8	0441654	\$10.18
1/4	1/4	0441656	10.62
3/8	1/4	0441658	11.78
3/8	3/8	0441660	12.08
3/8	1/2	0441662	18.51
1/2	3/8	0441663	18.08

Swivel Male Run Tee

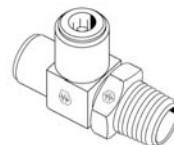

Tube O.D.	MPT	Part No.	Price /Each
1/4	1/8	0441655	\$10.86
1/4	1/4	0441657	12.58
3/8	1/4	0441659	14.85
3/8	3/8	0441661	17.95
1/2	3/8	0441664	19.67
1/2	1/4	0441665	19.30
1/2	1/2	0441666	22.93

Male Branch Tee

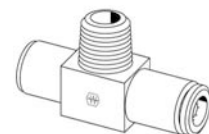

Tube O.D.	MPT	Part No.	Price /Each
1/4	1/8	0441668	\$9.88
1/4	1/4	0441670	10.23
3/8	1/4	0441672	11.49
3/8	3/8	0441675	11.81
1/2	3/8	0441677	16.10
1/2	1/4	0441679	17.17
1/2	1/2	0441681	20.04

Swivel Male Branch Tee

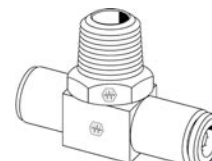

Tube O.D.	MPT	Part No.	Price /Each
1/4	1/8	0441669	\$11.19
1/4	1/4	0441671	12.83
3/8	1/4	0441673	15.65
3/8	1/8	0441674	17.36
3/8	3/8	0441676	16.69
1/2	3/8	0441678	21.50
1/2	1/4	0441680	21.73
1/2	1/2	0441682	23.12

QUICK CONNECT & BRASS AIR BRAKE FITTINGS

Quick Connect Air Brake® Cont.

EATON | Weatherhead

Female Bulkhead Union

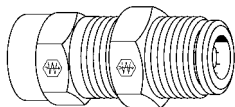

Tube O.D.	FPT	Part No.	Price /Each
1/4	1/4	0441683	\$11.50
3/8	3/8	0441684	15.97
1/2	1/2	0441685	19.87

Quick Connect Bulkhead Union

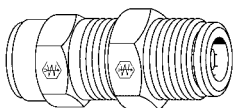

Tube O.D.	Part No.	Price /Each
1/4	0441686	\$10.62
3/8	0441687	14.47
1/2	0441688	16.64
5/8	0441689	20.90

Male Elbow 45°

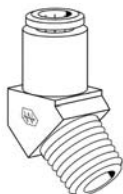

Tube O.D.	MPT	Part No.	Price /Each
1/4	1/8	0441690	\$6.98
1/4	1/4	0441692	12.21
3/8	1/4	0441694	9.55
3/8	1/8	0441696	10.70
3/8	3/8	0441698	11.25
3/8	1/2	0441700	12.36
1/2	3/8	0441701	11.13
1/2	1/4	0441703	11.35
1/2	1/2	0441705	11.93
5/8	1/2	0441707	15.14
3/4	1/2	0441709	21.39

Swivel Male Elbow 45°

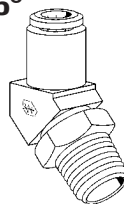

Tube O.D.	MPT	Part No.	Price /Each
1/4	1/8	0441691	\$8.42
1/4	1/4	0441693	10.17
3/8	1/4	0441695	12.02
3/8	1/8	0441697	12.32
3/8	3/8	0441699	16.34
1/2	3/8	0441702	16.75
1/2	1/4	0441704	15.12
1/2	1/2	0441706	16.48

Brass Air Brake Fittings For Nylon Tubing

Brass air brake fittings for nylon tubing are compression style, flareless fittings that meet SAE and DOT specifications.



Sleeve

Tube O.D.	Vendor No.	Part No.	Price /Each	Utility
1/4	1460X4	67800	\$0.14	
3/8	1460X6	67801	0.18	
1/2	1460X8	67802	0.24	
5/8	1460X10	67803	0.51	
3/4	1460X12	67804	1.05	

EATON | Weatherhead

Nut

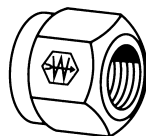

Tube O.D.	Vendor No.	Weatherhead		Utility	
		Part No.	Price /Each	Part No.	Price /Each
1/4	1461X4	440750-131280	\$0.52	67770	\$0.39
3/8	1461X6	440751-131280	0.45	67771	0.44
1/2	1461X8	440752-131280	0.86	67772	0.75
5/8	1461X10	440753-131280	1.49	67773	1.45
3/4	1461X12	440754-131280	2.27	67774	2.17

Insert

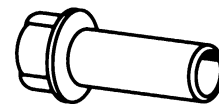

Tube O.D.	Vendor No.	Weatherhead		Utility	
		Part No.	Price /Each	Part No.	Price /Each
1/4	1484X4	440755-131280	\$0.19	67765	\$0.18
3/8	1484X6	440756-131280	0.21	67766	0.19
1/2	1484X8	440757-131280	0.33	67767	0.31
5/8	1484X10	440758-131280	0.75	67768	0.62
3/4	1484X12	440759-131280	0.91	67769	0.84

Union

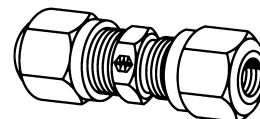

Tube O.D.	Vendor No.	Weatherhead		Utility	
		Part No.	Price /Each	Part No.	Price /Each
1/4	1462X4	440760-131280	\$1.95	67812	\$1.90
3/8	1462X6	440761-131280	2.55	67813	2.49
1/2	1462X8	440762-131280	3.83	67814	3.79
5/8	1462X10	440763-131280	8.49	67815	8.46
3/4	1462X12	440764-131280	14.77	67816	11.56

Female Connector

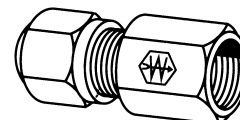

Tube O.D.	FPT	Vendor No.	Weatherhead		Utility	
			Part No.	Price /Each	Part No.	Price /Each
1/4	1/8				67353	\$2.07
1/4	1/4				67352	5.93
3/8	1/8				67825	3.94
3/8	1/4	1466X6	440766-131280	2.65	67826	3.28
3/8	3/8	1466X6X6	440767-131280	4.28	67827	2.71
1/2	3/8	1466X8	440768-131280	4.35	67828	6.96
1/2	1/2				67829	7.15

BRASS AIR BRAKE FITTING FOR NYLON TUBING

Brass Air Brake Fittings For Nylon Tubing

FAT-N | Weatherhead

Male Connector

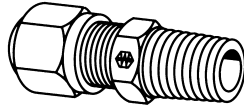

Tube O.D.	MPT	Vendor No.	Weatherhead		Utility	
			Part No.	Price /Each	Part No.	Price /Each
1/4	1/16	1468X4X1	440770-131280	\$3.31		
1/4	1/8	1468X4	440771-131280	1.45	67830	\$1.40
1/4	1/4	1468X4X4	440772-131280	1.69	67831	1.66
1/4	3/8	1468X4X6	440773-131280	1.98	67832	1.95
3/8	1/8	1468X6X2	440774-131280	1.79	67833	1.77
3/8	1/4	1468X6	440775-131280	1.73	67834	1.66
3/8*	3/8	1468X6X6	440776-131280	1.94	67835	1.85
3/8	1/2	1468X6X8	440777-131280	2.85	67836	2.78
1/2*	1/4	1468X8X4	440778-131280	3.25	67837	3.21
1/2	3/8	1468X8	440779-131280	2.72	67838	2.61
1/2	1/2	1468X8X8	440780-131280	3.28	67839	3.16
1/2	3/4	1468X8X12	440781-131280	9.36		
5/8	3/8	1468X10X6	440782-131280	5.29	67840	5.25
5/8	1/2	1468X10	440783-131280	4.55	67841	3.90
5/8	3/4	1468X10X12	440784-131280	14.78		
3/4	1/2	1468X12	440785-131280	7.45	67842	7.44
3/4	3/4	1468X12X12	440786-131280	10.35	67843	10.31

Union Tee

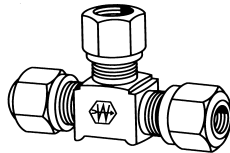

Tube O.D. x Tube O.D.	Vendor No.	Weatherhead		Utility	
		Part No.	Price /Each	Part No.	Price /Each
1/4	1464X4	440787-131280	\$4.15	67817	\$4.13
3/8 x3/8 x1/4	1464X6X6X4	440789-131280	12.21		
3/8	1464x6	440790-131280	4.69	67818	4.65
1/2 x1/2 x3/8	1464X8X8X6	440793-131280	20.33		
1/2	1464X8	440794-131280	7.85	67819	7.04
5/8				67820	25.20

*Reducing

Male Branch Tee

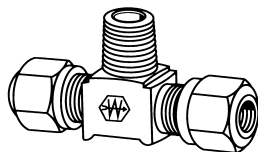

Tube x Tube x MPT	Vendor No.	Weatherhead		Utility	
		Part No.	Price /Each	Part No.	Price /Each
1/4 x1/4 x1/8	1472X4	440796-131280	\$4.29	67867	\$4.25
1/4 x1/4 x1/4				67868	4.28
3/8 x1/4 x1/4	1472X6X4X4	440797-131280	9.79		
3/8 x3/8 x1/8				67869	4.90
3/8 x3/8 x1/4	1472X6	440799-131280	3.89	67870	3.76
3/8 x3/8 x3/8	1472X6X6X6	440800-131280	4.46	67871	4.30
1/2 x3/8 x3/8	1472X8X6X6	440801-131280	12.31		
1/2 x1/2 x1/4	1472X8X8X4	440802-131280	14.45		
1/2 x1/2 x3/8	1472X8	440803-131280	5.65	67872	5.60
1/2 x1/2 x1/2				67873	7.59
5/8 x5/8 x1/2				67874	24.12

Bulkhead Union

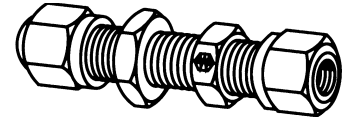

Tube O.D.	Vendor No.	Weatherhead		Utility	
		Part No.	Price /Each	Part No.	Price /Each
1/4	1474X4	440805-131280	\$7.84		
3/8	1474X6	440806-131280	6.92	67810	\$6.03
1/2				67811	7.34

Male Run Tee

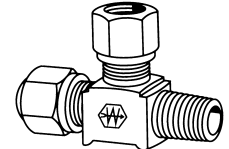

Tube x Tube x MPT	Vendor No.	Weatherhead		Utility	
		Part No.	Price /Each	Part No.	Price /Each
1/4 x1/4 x1/8	1471X4	440809-131280	\$4.52	67861	\$4.48
1/4 x1/4 x1/4				67351	6.35
3/8 x1/4 x1/4	1471X6X4X4	440810-131280	9.78		
3/8 x3/8 x1/4	1471X6	440811-131280	3.98	67862	3.87
3/8 x3/8 x3/8	1471X6X6X6	440812-131280	4.62	67863	4.57
1/2 x1/2 x3/8				67864	7.20
1/2 x1/2 x1/2				67865	8.34
5/8 x5/8 x1/2				67866	20.58

90° Union Elbow

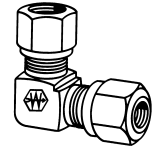

Tube O.D.	Part No.	Price /Each
1/4	67821	\$5.95
3/8	67822	3.81
1/2	67823	9.05
5/8	67824	10.07

90° Male Elbow

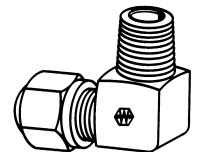

Tube O.D.	MPT	Vendor No.	Weatherhead		Utility	
			Part No.	Price /Each	Part No.	Price /Each
1/4	1/8	1469X4	440818-131280	\$1.79	67844	\$1.75
1/4	1/4	1469X4X4	440819-131280	1.88	67845	1.85
1/4	3/8	1469X4X6	440820-131280	6.99		
3/8	1/8	1469X6X2	440821-131280	2.22	67846	2.17
3/8	1/4	1469X6	440822-131280	2.25	67847	2.11
3/8	3/8	1469X6X6	440823-131280	2.57	67848	2.53
3/8	1/2	1469X6X8	440824-131280	3.23	67849	3.07
1/2	1/4	1469X8X4	440825-131280	3.52	67850	3.31
1/2	3/8	1469X8	440826-131280	3.35	67851	3.33
1/2	1/2	1469X8X8	440827-131280	4.33	67852	4.23
5/8	3/8	1469X10X6	440828-131280	8.99	67853	8.92
5/8	1/2	1469X10	440829-131280	9.41	67854	9.35
5/8	3/4	1469X10X12	440830-131280	26.75		
3/4	1/2	1469X12	440832-131280	11.56	67855	10.83

Hydraulic/Pneumatic
Fleet

BRASS FITTINGS FOR NYLON & COPPER TUBING

Brass Air Brake Fittings For Nylon Tubing Cont.

90° Female Elbow

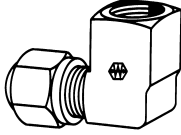

Tube O.D.	FPT	Utility Price Part No.	Price /Each
3/8	1/8	67856	\$2.74
3/8	1/4	67857	3.73
3/8	3/8	67858	4.41
1/2	3/8	67859	6.12
1/2	1/2	67860	13.25

EATON | Weatherhead

45° Male Elbow

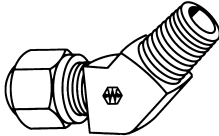

Tube O.D.	MPT	Vendor No.	Weatherhead		Utility	
			Part No.	Price /Each	Part No.	Price /Each
1/4	1/8	1480X4	440837-131280	\$4.15	67875	\$4.10
1/4	1/4				67876	4.01
3/8	1/8				67877	6.57
3/8	1/4	1480X6	440838-131280	3.21	67878	2.99
3/8	3/8	1480X6X6	440839-131280	3.78	67879	3.73
3/8	1/2				67880	6.43
1/2	1/4	1480X8X4	440840-131280	7.71	67881	6.56
1/2	3/8	1480X8	440841-131280	4.62	67882	4.54
1/2	1/2	1480X8X8	440842-131280	6.48	67883	6.25
5/8	1/2	1480X10	440843-131280	9.98	67884	9.93

90° Male Elbow (Long)

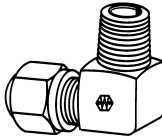

Tube O.D.	MPT	Vendor No.	Part No.	Price /Each
3/8	1/4	1469X6L	440845-131280	\$6.54
1/2	3/8	1469X8L	440846-131280	8.43

Female Branch Tee

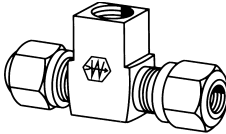

Tube x Tube x FPT	Vendor No.	Part No.	Price /Each
3/8 x 3/8 x 1/4	1477X6	440848-131280	\$16.27
5/8 x 5/8 x 1/4	1477X10X10X4	440850-131280	16.29

Gage Ring



Tube O.D.	Vendor No.	Part No.	Price /Each
1/4	1485X4	440855-131280	\$0.30
3/8	1485X6	440856-131280	0.38
1/2	1485X8	440857-131280	0.32
5/8	1485X10	440858-131280	0.34
3/4	1485X12	440859-131280	0.37

Brass Air Brake Fittings For Copper Tubing

EATON | Weatherhead

Brass air brake fittings for copper tubing are compression style, flareless fittings that meet SAE and DOT specifications.

Sleeve

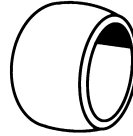

Tube O.D.	Vendor No.	Weatherhead		Utility	
		Part No.	Price /Each	Part No.	Price /Each
1/4	1360X4	440860-131280	\$0.13	69401	\$0.10
3/8	1360X6	440861-131280	0.21	69402	0.19
1/2	1360X8	440862-131280	0.26	69403	0.26
5/8	1360X10	440863-131280	0.52	69404	0.49
3/4	1360X12	440864-131280	1.15	69405	1.09

Nut

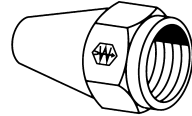

Tube O.D.	Vendor No.	Weatherhead		Utility	
		Part No.	Price /Each	Part No.	Price /Each
1/4	1361X4	440865-131280	\$0.52	69473	\$0.48
3/8	1361X6	440866-131280	0.71	69474	0.68
1/2	1361X8	440867-131280	1.22	69475	1.15
5/8	1361X10	440868-131280	1.57	69476	1.49
3/4	1361X12	440870-131280	3.07		

Compressor Nut with V-groove Hex.

Insert (To Convert To Nylon Tubing)

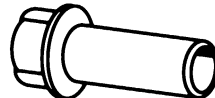

Tube O.D.	Vendor No.	Weatherhead		Utility	
		Part No.	Price /Each	Part No.	Price /Each
1/4	1484X4	440755-131280	\$0.19	67765	\$0.18
3/8	1484X6	440756-131280	0.21	67766	0.19
1/2	1484X8	440757-131280	0.33	67767	0.31
5/8	1484X10	440758-131280	0.75	67768	0.62
3/4	1484X12	440759-131280	0.91	67769	0.84

Sleeve (To Convert To Nylon Tubing)



Tube O.D.	Vendor No.	Weatherhead		Price /Each
		Part No.	Price /Each	
1/4	1460X4	440745-131280	\$0.15	
3/8	1460X6	440746-131280	0.18	
1/2	1460X8	440747-131280	0.23	
5/8	1460X10	440748-131280	0.50	
3/4	1460X12	440749-131280	0.82	

Nut (To Convert To Nylon Tubing)

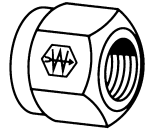

Tube O.D.	Vendor No.	Weatherhead		Utility	
		Part No.	Price /Each	Part No.	Price /Each
1/4	1461X4	440750-131280	\$0.52	67770	\$0.39
3/8	1461X6	440751-131280	0.45	67771	0.44
1/2	1461X8	440752-131280	0.86	67772	0.75
5/8	1461X10	440753-131280	1.49	67773	1.45
3/4	1461X12	440754-131280	2.27	67774	2.17

Union



Tube O.D.	Vendor No.	Weatherhead		Utility	
		Part No.	Price /Each	Part No.	Price /Each
1/4	1362X4	440871-131280	\$1.89	69407	\$1.81
3/8	1362X6	440872-131280	2.23	69408	1.93
1/2	1362X8	440873-131280	4.59	69409	3.76
5/8	1362X10	440874-131280	5.71	69410	4.86
3/4	1362X12	440875-131280	9.23	69411	7.99

90° Union Elbow

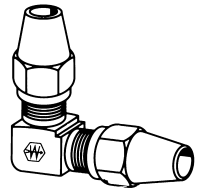

Tube O.D.	Utility	
	Price Part No.	/Each
1/4	67779	\$6.11
3/8	67780	4.05
1/2	67781	7.28
5/8	67782	14.49

BRASS AIR BRAKE FITTINGS FOR COPPER TUBING

Brass Air Brake Fittings For Copper Tubing Cont.

EATON | Weatherhead

Male Connector

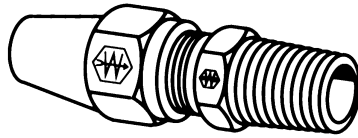

Tube O.D.	MPT	Vendor No.	Weatherhead		Utility	
			Part No.	Price /Each	Part No.	Price /Each
1/4	1/8	1368X4	440880-131280	\$0.95	69417	\$0.84
1/4	1/4	1368X4X4	440881-131280	1.15	69418	1.00
3/8	1/8	1368X6X2	440882-131280	1.62	69420	1.53
3/8	1/4	1368X6	440883-131280	1.62	69421	1.53
3/8	3/8	1368X6X6	440884-131280	1.95	69422	1.88
3/8	1/2	1368X6X8	440885-131280	4.55	69423	4.49
1/2	1/4	1368X8X4	440886-131280	2.36	69424	2.05
1/2	3/8	1368X8	440887-131280	2.20	69425	1.91
1/2	1/2	1368X8X8	440888-131280	2.64	69426	2.28
5/8	3/8	1368X10X6	440889-131280	4.27	69427	3.52
5/8	1/2	1368X10	440890-131280	3.19	69428	2.76
3/4	1/2	1368X12	440891-131280	11.93		
3/4	3/4	1368X12X12	440892-131280	14.47	69452	14.30

Female Connector

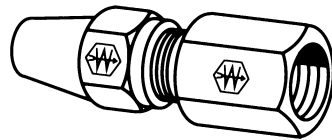

Tube O.D.	FPT	Vendor No.	Weatherhead		Utility	
			Part No.	Price /Each	Part No.	Price /Each
1/4	1/8				67783	\$1.16
1/4	1/4				67784	1.31
3/8	1/8				67785	4.58
3/8	1/4	1366X6	440894-131280	4.38	67786	4.31
3/8	3/8	1366X6X6	440895-131280	4.82	67787	3.25
1/2	3/8	1366X8	440896-131280	6.34	67788	5.98
1/2	1/2				67789	10.38

90° Male Elbow

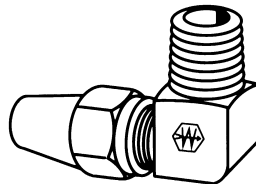

Tube O.D.	MPT	Vendor No.	Weatherhead		Utility	
			Part No.	Price /Each	Part No.	Price /Each
1/4	1/8	1369X4	440897-131280	\$1.48	69430	\$1.29
1/4	1/4	1369X4X4	440898-131280	1.61	69431	1.39
3/8	1/8	1369X6X2	440899-131280	2.24	69433	2.14
3/8	1/4	1369X6	440900-131280	2.45	69434	2.34
3/8	3/8	1369X6X6	440901-131280	2.86	69435	2.77
3/8	1/2	1369X6X8	440902-131280	6.65	69436	3.60
1/2	1/4	1369X8X4	440903-131280	7.76	69437	3.46
1/2	3/8	1369X8	440904-131280	4.41	69438	4.36
1/2	1/2	1369X8X8	440905-131280	4.13	69439	4.05
5/8	3/8	1369X10X6	440906-131280	8.80	69440	5.20
5/8	1/2	1369X10	440907-131280	7.24	69441	6.98
3/4	1/2				69442	9.09
3/4	3/4				69443	11.50

90° Female Elbow

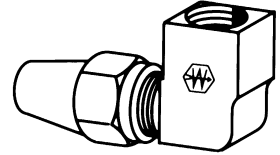

Tube O.D.	Price FPT	Utility	
		Part No.	/Each
3/8	1/8	67357	\$2.01
3/8	1/4	67791	3.21
3/8	3/8	67792	3.53
1/2	3/8	67356	3.28
1/2	1/2	67793	4.07
5/8	1/2	67794	10.54

45° Male Elbow

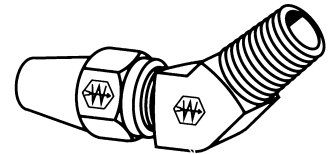

Tube O.D.	MPT	Vendor No.	Weatherhead		Utility	
			Part No.	Price /Each	Part No.	Price /Each
1/4	1/8				69455	\$2.80
3/8	1/8				69457	5.94
3/8	1/4	1380X6	440911-131280	4.74	69458	3.56
3/8	3/8	1380X6X6	440912-131280	4.41	69459	4.20
1/2	3/8	1380X8	440913-131280	4.33	69461	4.25
5/8	1/2	1380X10	440914-131280	12.76	69463	7.09
3/8	1/2				69460	5.04
1/2	1/2				69462	5.00

Union Tee

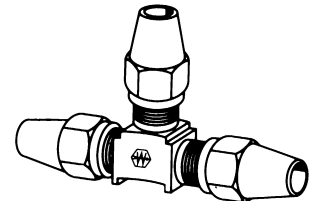

Tube O.D.	Vendor No.	Weatherhead		Utility	
		Part No.	Price /Each	Part No.	Price /Each
1/4				67775	\$3.19
3/8	1364X6	440915-131280	5.95	67776	5.89
1/2	1364X8	440917-131280	9.48	67777	7.14
5/8				67778	9.89

Male Run Tee

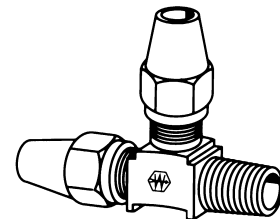

Tube O.D.	MPT	Vendor No.	Weatherhead		Utility	
			Part No.	Price /Each	Part No.	Price /Each
1/4	1/8				69466	\$3.09
1/4	1/4				69467	4.28
3/8	1/4	1371X6	440918-131280	6.74	69470	3.97
3/8	3/8	1371X6X6X6	440919-131280	7.95	69471	4.95
1/2	3/8				69472	5.88
1/2	1/2				67355	5.88

Hydraulic/Pneumatic
Fleet

The : symbol after a price denotes that it is a Direct Ship Product (DSP) and shipping, availability & lead times may vary.

BRASS FITTINGS FOR COPPER TUBING & HOSE

Brass Air Brake Fittings For Copper Tubing Cont.

FAT•N | Weatherhead

Male Branch Tee

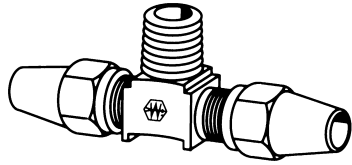

Tube O.D.	MPT	Vendor No.	Weatherhead		Utility	
			Part No.	Price /Each	Part No.	Price /Each
1/4	1/8				69444	\$3.48
3/8	1/8				69446	4.11
3/8	1/4	1372X6	440922-131280	4.28	69447	3.90
3/8	3/8	1372X6X6X6	440923-131280	7.51	69448	6.72
1/2	3/8	1372X8	440924-131280	10.79	69449	9.76
1/2	1/2				69450	7.28

90° Male Elbow - Long

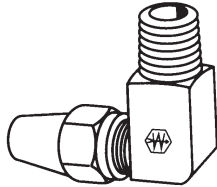

Tube O.D.	MPT	Vendor No.	Part No.	Price /Each
3/8	1/4	1369X6L	440926-131280	\$5.62
1/2	3/8	1369X8L	440927-131280	8.55

Bulkhead Coupling (F x L)

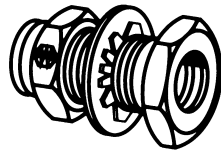

FPT	Length	Vendor No.	Part No.	Price /Each
1/4	1.5	1344	440113-131280	\$5.21
1/4	.94	1345	440112-131280	4.51
3/8	-	1346	440114-131280	7.09

Bulkhead Coupling (M x F x L)



MPT	FPT	Length	Vendor No.	Part No.	Price /Each
1/2	1/4	2.16	1340	440930-131280	\$7.54
1/2	1/4	2.53	1341	440931-131280	7.94
1/2	1/4	2.94	1342	440932-131280	11.66
1/2	1/4	3.94	1343	440933-131280	13.31

Truck Hydraulic Hose

FAT•N | Weatherhead

*** ALL STARRED ITEMS ARE BULK QUANTITIES ***

H069 General Purpose Truck Hose SAE 100R5 - SAE J1402 Type II* - DOT All*

*Sizes 4 through 12 only

• **Typical Application:** General purpose truck and hydraulic hose. For use in air brake, fuel, grease lines, high temperature petroleum oils and medium pressure hydraulic applications. -16 through -48 sizes are not SAE or DOT approved for air brake applications.

• **Inner Tube:** Nitrile

• **Reinforcement:** 1 Fiber Braid; 1 Steel Braid

• **Cover:** Fiber Braid

• **Temperature Range: Air brake:** -40°F to +200°F (-40°C to +93°C)

• **Hydraulic Fluid:** -40°F to +212°F (-40°C to +100°C)

• **Hose Ends:** Coll-O-Crimp 069 E-Series except for 40 and 48 Sizes; Field Attachable 069 D-Series; 247 N-Series



Specifications

Vendor No.	Hose I.D.	Hose O.D.	Work Pressure (PSI)	Min. Burst Pressure (PSI)	Min. Bend Radii	Wt./100 (ft)	Length
H06904	3/16	33/64	3000	12000	3	16	50', 250'
H06905	1/4	37/64	3000	12000	3-3/8	20	50', 250'
H06906	5/16	43/64	2250	9000	4	23	50', 250'
H06908	13/32	49/64	2000	8000	4-5/8	27	50', 250'
H06910	1/2	59/64	1750	7000	5-1/2	36	50', 250'
H06912	5/8	1-5/64	1500	6000	6-1/2	44	50', 250'
H06916	7/8	1-15/64	800	3200	7-3/8	46	50', 250'
H06920	1-1/8	1-1/2	625	2500	9	51	50', 150'
H06924	1-3/8	1-3/4	500	2000	10-1/2	62	50', 100'
H06932	1-13/16	2-7/32	350	1400	13-1/4	85	50', 100'
H06940	2-3/8	2-7/8	350	1400	24	143	50'
H06948	3	3-9/16	200	800	33	209	50'

Fastenal Branch Personnel: Please Sold Request number of feet when ordering.

Part No.	Vendor No.	Hose I.D.	Price /Ft
400223-131280	H06904-50	3/16	\$4.10
400224-131280	H06904-250	*3/16	3.40
400225-131280	H06905-50	1/4	3.50
400226-131280	H06905-250	*1/4	4.34
400227-131280	H06906-50	5/16	6.62
400228-131280	H06906-250	*5/16	4.10
400229-131280	H06908-50	13/32	4.40
400230-131280	H06908-250	*13/32	4.40
400231-131280	H06910-50	1/2	5.30
400232-131280	H06910-250	*1/2	6.58
400233-131280	H06912-50	5/8	6.53
400234-131280	H06912-250	*5/8	8.08
400235-131280	H06916-50	7/8	7.13
0446958	H06916-250	*7/8	7.08
400236-131280	H06920-50	1-1/8	9.50
0446959	H06920-150	*1-1/8	13.34
400237-131280	H06924-50	1-3/8	14.76
0446960	H06924-100	*1-3/8	20.32
400238-131280	H06932-50	1-13/16	21.88

TRUCK HYDRAULIC HOSE & MISCELLANEOUS FLEET HOSES

Truck Hydraulic Hose Cont.

FAT-N

Weatherhead



H166 Truck Hose SAE DOT AII, SAE J1402 Type AII

- **Typical Application:** General-purpose truck and air brake hose. For use in air brake, fuel, diesel fuel and high temperatures petroleum oil applications
- **Inner Tube:** Nitrile
- **Reinforcement:** 1 Fiber Braid; 1 Stainless Steel Braid
- **Cover:** Fiber Braid
- **Temperature Range: Air Brake:** -40°F to +200°F (-40°C to +93°C)
Hot Oil: -40°F to +302°F (-40°C to +150°C) **Hydraulic Fluid:** -40°F to +212°F (-40°C to +100°C)
- **Note:** 16 and 20 Sizes are not SAE or DOT approved.
- **Hose Ends:** Coll-O-Crimp® 069 E-Series; Field Attachable 069 D-Series; 247 N-Series

Specifications

Vendor No.	Hose I.D.	Hose O.D.	Work Pressure (PSI)	Min. Burst Pressure (PSI)	Min. Bend Radii	Wt./100 (ft)	Length
H16604	3/16	33/64	1500	6000	1-1/2	11	50', 250'
H16605	1/4	37/64	500	2000	1-3/4	13	50', 250'
H16606	5/16	43/64	500	2000	2	18	50', 250'
H16608	13/32	49/64	500	2000	2-5/16	21	50', 250'
H16610	1/2	59/64	450	1800	2-3/4	29	50', 250'
H16612	5/8	1-5/64	450	1800	3-1/4	37	50', 250'
H16616	7/8	1-15/64	250	1000	4	38	50', 250'
H16620	1-1/8	1-33/64	250	1000	5-1/2	46	50'

Part No.	Vendor No.	Hose I.D.	Price /Ft
400209-131280	H16604-50	3/16	\$4.75
400211-131280	H16605-50	1/4	5.05
400213-131280	H16606-50	5/16	5.80
400215-131280	H16608-50	13/32	6.13
400217-131280	H16610-50	1/2	7.10

H213 Truck Hose SAE J1402 Type AI, DOT AI



- **Typical Application:** General-purpose truck hose. For use in air brake, fuel, diesel fuel and high temperature petroleum oil applications.
- **Inner Tube:** CPE
- **Reinforcement:** 1 Fiber Braid; 1 Steel Braid
- **Cover:** Fiber Braid
- **Temperature Range: Air Brake:** -40°F to +200°F (-40°C to +93°C)
Hot Oil and Fluids: -50°F to +302°F (-45°C to + 150°C)
- **Note:** 16 Size is not SAE or DOT approved for air brake.
- **Hose Ends:** Field Attachable 213 B-Series.

Specifications

Vendor No.	Hose I.D.	Hose O.D.	Work Pressure (PSI)	Min. Burst Pressure (PSI)	Min. Bend Radii	Wt./100 (ft)	Length
H21304*	3/16	31/64	2000	8000	3/4	12	50', 250'
H21305*	1/4	35/64	1500	6000	1	13	50', 250'
H21306*	5/16	39/64	1500	6000	1-1/4	16	50', 250'
H21308*	13/32	47/64	1250	5000	1-3/4	19	50', 250'
H21310*	1/2	53/64	1000	4000	2-1/4	21	50', 250'
H21312*	5/8	61/64	750	3000	2-3/4	26	50', 250'
H21316*	7/8	1-13/64	400	1600	3-1/2	32	50'

Part No.	Vendor No.	Hose I.D.	Price /Ft
400194-131280	H21304-50	3/16	\$3.50
400195-131280	H21304-250	*3/16	3.45
400196-131280	H21305-50	1/4	3.86
400197-131280	H21305-250	*1/4	3.82
400198-131280	H21306-50	5/16	4.22
400199-131280	H21306-250	*5/16	4.12
400200-131280	H21308-50	13/32	4.13
400201-131280	H21308-250	*13/32	4.08
400202-131280	H21310-50	1/2	4.98
400203-131280	H21310-250	*1/2	4.93
400204-131280	H21312-50	5/8	6.33
400205-131280	H21312-250	*5/8	6.28
400206-131280	H21316-50	7/8	7.10

The * symbol after a price denotes that it is a Direct Ship Product (DSP) and shipping, availability & lead times may vary.

H229 Truck Hose SAE J1402 Type AII, DOT AII



- **Typical Application:** General purpose truck hose. High temperature hydraulic, air brake and diesel fuel applications.
- **Inner Tube:** Nitrile
- **Reinforcement:** Two Fiber Braid
- **Cover:** Fiber Braid
- **Temperature Range: Air Brake:** -40° to +200°F (-40° to +93°C)
Hydraulic Fluids: -40° to +300°F (-40° to +150°C)
- **Hose Ends:** Coll-O-Crimp 069 E-Series; 229 P-Series (-4 to -10) except 12 Size; Field Attachable 247 N-Series; 069 D-Series

Specifications

Vendor No.	Hose I.D.	Hose O.D.	Work Pressure (PSI)	Min. Burst Pressure (PSI)	Min. Bend Radii	Length
H22904	3/16	33/64	225	2000	1-1/2	50', 250'
H22906	5/16	43/64	225	2000	2	50', 250'
H22908	13/32	49/64	225	2000	2-5/16	50', 250'
H22910	1/2	59/64	225	1800	2-3/4	50', 250'
H22912	5/8	1-5/64	225	1800	3-1/4	50', 250'

Part No.	Vendor No.	Hose I.D.	Price /Ft
0400644	H22904-50	3/16	\$3.23
0400646	H22906-50	5/16	3.60
0400648	H22908-50	13/32	3.90
0400650	H22910-50	1/2	4.98
0400652	H22912-50	5/8	5.90

Miscellaneous Fleet Hoses

FAT-N

Weatherhead

H338 Air Brake Hose SAE J1402 A Dot AII

- **Typical Application:** Air brake hose lines
- **Inner Tube:** Synthetic EPDM
- **Reinforcement:** Multi-Fiber Spiral
- **Cover:** Synthetic EPDM
- **Temperature Range:** -40°F to +200°F (-40°C to +93°C)
- **Hose Ends:** Coll-O-Crimp® 338 P-Series; Field Attachable 338 B-Series



Specifications

Vendor No.	Hose I.D.	Hose O.D.	Work Pressure (PSI)	Min. Burst Pressure (PSI)	Min. Bend Radii	Wt./100 (ft)	Length
H33806	3/8	3/4	225	900	3-1/2	24	50', 250'
H33808	1/2	7/8	225	900	4	29	50', 250'

Fastenal Branch Personnel: Please Sold Request number of feet when ordering.

Part No.	Vendor No.	Hose I.D.	Price /Ft
400059-131280	H33806-50	3/8	\$1.34
400060-131280	H33806-250	*3/8	1.25
400061-131280	H33808-50	1/2	1.87
400062-131280	H33808-250	*1/2	1.65

MISCELLANEOUS FLEET HOSES

Miscellaneous Fleet Hoses Cont.

Hydraulic/Pneumatic Fleet

FAT•N | Weatherhead

H057 Fuel Line Hose

SAE 30R7

- **Typical Application:** Low-pressure/high-temperature fuel for passenger car and light truck; also small engine applications.
- **Inner Tube:** Nitrile
- **Reinforcement:** 1 Fiber Braid
- **Cover:** Hypalon
- **Temperature Range:** -40°F to +257°F (-40°C to +125°C)
- **Note:** Not intended for fuel injection applications.
- **Hose Ends:** Field Attachable 057 B-Series



Specifications

Vendor No.	Hose I.D.	Hose O.D.	Work Pressure (PSI)	Min. Burst Pressure (PSI)	Min. Bend Radii	Inch Merc. Vacuum	Wt/100 (ft)	Length
H05703	3/16	13/32	50	250	2	24	6	25', 100'
H05704	1/4	1/2	50	250	2-1/2	24	9	25', 100'
H05705	5/16	9/16	50	250	2-3/4	24	11	25', 100'
H05706	3/8	5/8	50	250	3	24	12	25', 50'
H05707	7/16	11/16	35	140	3-1/4	24	16	25', 50'

Fastenal Branch Personnel: Please Sold Request number of feet when ordering.

Part No.	Vendor No.	Hose I.D.	Price /Ft
400049-131280	H05703-25	3/16	\$2.03
400050-131280	H05703-100	*3/16	1.72
400051-131280	H05704-25	1/4	2.18
400052-131280	H05704-100	*1/4	1.78
400053-131280	H05705-25	5/16	2.42
400054-131280	H05705-100	*5/16	1.93
400055-131280	H05706-25	3/8	1.83
400056-131280	H05706-50	*3/8	1.60
400057-131280	H05707-25	7/16	2.82
400058-131280	H05707-50	*7/16	2.59

H077 Fuel Injection Hose

SAE 30R9

- **Typical Application:** Designed specifically for electronic fuel injection systems.
- **Inner Tube:** Fluoroelastomer Veneer
- **Reinforcement:** Multi-Fiber Braid
- **Cover:** ECO (Epichlorohydrin Copolymer)
- **Temperature Range:** -30°F to +275°F (-34°C to +135°C)
- **Hose Ends:** Hose Clamps



Specifications

Vendor No.	Hose I.D.	Hose O.D.	Work Pressure (PSI)	Min. Burst Pressure (PSI)	Min. Bend Radii	Wt/100 (ft)	Length
H07704-10	1/4	1/2	125	900	3	11	10'
H07705-10	5/16	9/16	125	900	3-3/4	13	10'
H07706-10	3/8	5/8	125	900	4-1/2	16	10'

Fastenal Branch Personnel: Please Sold Request number of feet when ordering.

Part No.	Vendor No.	Hose I.D.	Price /Ft
0400610	H07704-10	*1/4	\$7.17
0400611	H07705-10	*5/16	7.79
0400612	H07706-10	*3/8	8.61

H324 Power Steering Hose

SAE J188 Type II

- **Typical Application:** Passenger Car/Light Truck power steering hose (Volumetric Expansion 8-17 cc/ft).
- **Inner Tube:** Neoprene
- **Reinforcement:** 2 Fiber Braids
- **Cover:** Neoprene
- **Temperature Range:** -40°F to +250°F (-40°C to +121°C)
- **Hose Ends:** Coll-O-Crimp® U-Series



Specifications

Vendor No.	Hose I.D.	Hose O.D.	Work Pressure (PSI)	Min. Burst Pressure (PSI)	Min. Bend Radii	Wt/100 (ft)	Length
H32406	3/8	3/4	1500	6000	3-1/8	24	50'

Fastenal Branch Personnel: Please Sold Request number of feet when ordering.

Part No.	Vendor No.	Hose I.D.	Price /Ft
400208-131280	H32406-50	*3/8	\$6.80

H757 Air Conditioning Hose

SAE J2064 Type C Class 1

- **Typical Application:** A refrigerant hose recommended for R134a and R12 applications. Ideal for heavy duty truck use as well as industrial and automotive applications.
- **Inner Tube:** Rubber/Nylon/Rubber
- **Reinforcement:** 1 Fiber Spiral
- **Cover:** Butyl (perforated)
- **Temperature Range:** -22°F to +257°F (-30°C to +125°C)
- **Hose Ends:** Coll-O-Crimp® 757 E-Series



Specifications

Vendor No.	Hose I.D.	Hose O.D.	Work Pressure (PSI)	Min. Burst Pressure (PSI)	Min. Bend Radii	Wt/100 (ft)	Length
H75706	5/16	9/16	400	2000	2	10	50', 100', 250'
H75708	13/32	11/16	400	2000	2-1/2	12	50', 100', 250'
H75710	1/2	3/4	350	1750	3	13	50', 100', 250'
H75712	5/8	15/16	350	1750	4	23	50', 100', 250'

Fastenal Branch Personnel: Please Sold Request number of feet when ordering.

Part No.	Vendor No.	Hose I.D.	Price /Ft
0401066	H75706-50	5/16	\$4.38
0401067	H75706-100	5/16	4.18
0401069	H75708-50	13/32	4.80
0401070	H75708-100	13/32	4.58
0401072	H75710-50	1/2	5.23
0401073	H75710-100	1/2	5.00
0401075	H75712-50	5/8	6.10
0401076	H75712-100	5/8	5.83

338 P-Series Air Brake Hose Ends

EAT•N | Weatherhead

Typical Application: Air brake hose lines
Compatible Hose: H338

Pressure: Determined by hose burst pressure
Material: CA360 Brass

Advantages: Saves time and easy to assemble. Excellent corrosion resistance.

Assemble With: T-400-1, T-410-1, T-420-1, T-440, T-465-1, T-460, T-462-1, T-480 and ET4000.

Label Set: FS-2900

Note: Refer to current price list for availability of cataloged items. Configurations and dimensions subject to change without notice.

Assembly Instructions:

1. Push collar onto hose until bottomed.
2. Push insert into hose until step on insert (or hex) is flush with collar.

Note: Swivel fittings require the use of a mandrel or an assembled adapter to push on the insert for assembly. Adapter can be removed after fitting assembly. Light lubricant may be required to assemble fitting into hose.

3. Check for bottoming by checking collar movement along insert. Hose is bottomed when collar cannot slide along insert.



Male Pipe Rigid

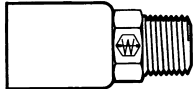

Hose x Pipe	Part No.	Vendor No.	Price /Each
3/8 x 1/4	410700-131280	33806P-104	\$3.07
3/8 x 3/8	410701-131280	33806P-106	3.44
3/8 x 1/2	410702-131280	33806P-108	4.38
1/2 x 3/8	410703-131280	33808P-106	3.67
1/2 x 1/2	410704-131280	33808P-108	4.56

Male Pipe Swivel

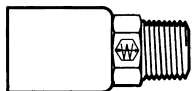

Hose x Pipe	Part No.	Vendor No.	Price /Each
3/8 x 3/8	410706-131280	33806P-J06	\$8.67

SAE 45° Female Swivel



Hose x Pipe	Part No.	Vendor No.	Price /Each
3/8 x 3/8	410707-131280	33806P-406	\$4.27
1/2 x 1/2	410708-131280	33808P-408	6.34

Air Brake Slider Line

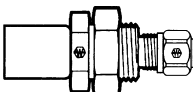

Hose x Pipe	Part No.	Vendor No.	Price /Each
3/8 x 3/8	410709-131280	33806P-Y66	\$13.02
3/8 x 1/2	410710-131280	33806P-Y68	13.96

Air Brake Swivel

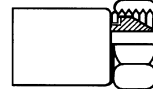

Hose x Pipe	Part No.	Vendor No.	Price /Each
3/8 x 3/8	410711-131280	33806P-Y76	\$5.99
1/2 x 3/8	410712-131280	33808P-Y76	8.09
1/2 x 1/2	410713-131280	33808P-Y78	12.05

Adaptor

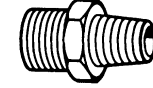

Hose x Pipe	Part No.	Vendor No.	Price /Each
3/8 x 1/4	410726-131280	1390X6	\$2.38
3/8 x 3/8	410727-131280	1390X6X6	2.71
3/8 x 1/2	410728-131280	1390X6X8	6.25

338 B-Series Air Brake Hose Ends

EAT•N | Weatherhead

Typical Application: Air brake hose lines

Compatible Hose: H338

Pressure: Determined by hose burst pressure.

Material: CA360 Brass

Advantages: Can be used for nearly any air brake line. Easy to assemble with a good selection of hose end configurations. Excellent corrosion resistance.

Label Set: FS-800

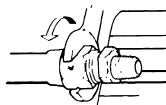

Male Connector

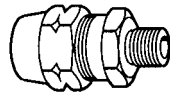

Hose x Pipe	Vendor No.	Weatherhead		Utility	
		Part No.	Price /Each	Part No.	Price /Each
3/8 x 1/4	33806B-Y24	410731-131280	\$6.81	68994	\$4.79
3/8 x 3/8	33806B-Y26	410732-131280	6.27	68995	5.83
3/8 x 1/2	33806B-Y28	410733-131280	8.38	68996	5.32
1/2 x 3/8	33808B-Y26	410734-131280	11.93		
1/2 x 1/2	33808B-Y28	410735-131280	12.37		

Male Connector With Spring Guard

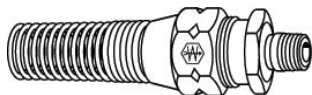

Hose x Pipe	Vendor No.	Weatherhead		Utility	
		Part No.	Price /Each	Part No.	Price /Each
3/8 x 1/4	33806B-Y34	410736-131280	\$6.99	68997	\$5.53
3/8 x 3/8	33806B-Y36	410737-131280	11.23	68998	5.59
3/8 x 1/2	33806B-Y38	410738-131280	10.23	68999	6.23
1/2 x 3/8	33808B-Y36	410739-131280	11.53		
1/2 x 1/2	33808B-Y38	410740-131280	11.02		

Female Connector

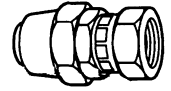

Hose x ABS Thread	Part No.	Vendor No.	Price /Each
3/8 x 3/4-20	410741-131280	33806B-Y76	\$9.33
1/2 x 7/8-20	410742-131280	33808B-Y78	13.81

Steel Nut

Female Connector With Adaptor

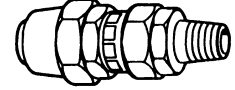

Hose x ABS Thread	Part No.	Vendor No.	Price /Each
3/8 x 3/4-20	410743-131280	33806B-Y84	\$11.24
3/8 x 3/8-20	410744-131280	33806B-Y86	11.88
1/2 x 7/8-20	410745-131280	33808B-Y86	13.34

Steel Nut

Hose Mender

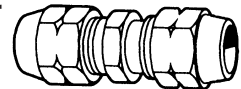

Hose	Part No.	Vendor No.	Price /Each
3/8	410746-131280	33806B-Y06	\$21.45
1/2	410747-131280	33808B-Y08	30.12

Hose Mender Body Only



Hose	Part No.	Vendor No.	Price /Each
3/8	410748-131280	33806-E	\$14.19

Spring Guard

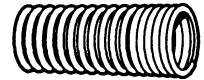

Hose	Part No.	Vendor No.	Price /Each
3/8	410754-131280	33806-C	\$1.60
1/2	410755-131280	33808-C	2.31

Insert Body Only

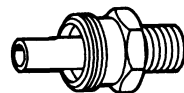

Hose x Pipe	Part No.	Vendor No.	Price /Each
3/8 x 1/4	410756-131280	1391X6	\$5.05
3/8 x 3/8	410757-131280	1391X6X6	5.64
3/8 x 1/2	410758-131280	1391X6X8	4.65
1/2 x 3/8	410759-131280	1391X8	6.19
1/2 x 1/2	410760-131280	1391X8X8	7.13

Sleeve



Hose	Vendor No.	Weatherhead		Utility	
		Part No.	Price /Each	Part No.	Price /Each
3/8	33806-A	410761-131280	\$1.50	68991	\$1.02
1/2	33808-A	410762-131280	2.52		

FIELD ATTACHABLE GENERAL PURPOSE HOSE ENDS

338 B-Series Hose Ends Cont.

EAT-N | Weatherhead

Nut

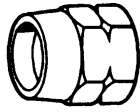

Hose	Vendor No.	WH		Price /Each
		Part No.	Utility Part No.	
3/8	33806-B	410763-131280	68992	\$3.23 \$1.34
1/2	33808-B	410764-131280	3.41	

Nut for Spring Guard

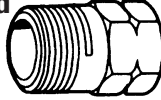

Hose	Part No.	Vendor No.	Price /Each
3/8	33806-D	410765-131280	\$4.39
1/2	33808-D	410766-131280	4.67

069 D-Series Field Attachable Hose Ends

EAT-N | Weatherhead

Typical Application: Medium pressure and high temperature hose lines for a variety of applications including truck, industrial and small engine where temperature may be a problem.

Compatible Hose: H069, H166, H169, H229, H366

Pressure: Determined by hose burst pressure.

Material: AISI/SAE 12L14 Carbon Steel

Plating: Zinc, yellow dichromate finish

Advantages: Very popular in heavy-duty truck markets. Can be used with a variety of hoses allowing for a diverse number of applications.

Assembly Instructions:

1. Lubricate mandrel insert threads and I.D. of hose.
2. Screw hose into socket (left-hand thread) until hose bottoms. Back out 1/4 turn.
3. Place insert on mandrel. Screw insert into socket. When assembling swivel ends, leave 1/32" clearance between swivel nut and socket.

Label Set: FS-600

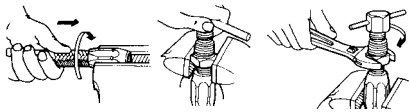

Male Pipe Rigid

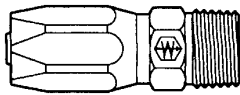

Hose x Pipe	Part No.	Vendor No.	Price /Each
3/16 x 1/8	412387-131280	06904D-102	\$11.10
3/16 x 1/4	412388-131280	06904D-104	4.15
1/4 x 1/4	412389-131280	06905D-104	4.50
5/16 x 1/4	412390-131280	06906D-104	4.28
13/32 x 3/8	412391-131280	06908D-106	17.27
13/32 x 1/2	412392-131280	06908D-108	20.90
1/2 x 1/2	412393-131280	06910D-108	9.48
5/8 x 3/4	412394-131280	06912D-112	42.89
7/8 x 3/4	412395-131280	06916D-112	25.26
7/8 x 1	412396-131280	06916D-116	16.28
1-13/16 x 2	412399-131280	06932D-132	84.50

*Brass Connection

SAE 37° (JIC) Female Swivel

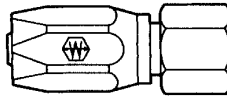

Hose x Tube	Part No.	Vendor No.	SAE OR JIC	Price /Each
3/16 x 1/4	412405-131280*	06904D-604	Both	\$11.70
1/4 x 5/16	412406-131280*	06905D-605	Both	19.41
5/16 x 3/8	412407-131280	06906D-606	SAE	6.29
5/16 x 3/8	412408-131280	06906D-606	Both	5.23
13/32 x 1/2	412409-131280	06908D-608	Both	7.15
1/2 x 5/8	412410-131280*	06910D-610	Both	11.90
5/8 x 3/4	412412-131280	06912D-612	Both	14.04
1-1/8 x 1-1/4	412414-131280	06920D-620	JIC	28.85
1-13/16 x 2	412416-131280	06932D-632	JIC	93.98

*Brass Construction

213 N-Series Field Attachable Hose Ends

EAT-N | Weatherhead

Typical Application:

Medium pressure and high temperature hose lines for a variety of applications including small engine where temperatures exist.

Compatible Hose: H213

Pressure: Determined by hose burst pressure for hose end configuration, whichever is lesser.

Material: AISI/SAE 12L14 Carbon Steel

Plating: Zinc, yellow dichromate finish

Advantages: Very popular in heavy-duty truck markets. Good selection of hose ends, including brass. Non-mandrel assembly.

Assembly Instructions:

1. Lubricate insert threads and I.D. of hose.
2. Screw hose into socket (left-hand thread) until hose bottoms. Back out 1/4 turn.
3. Screw insert into socket until insert touches socket.

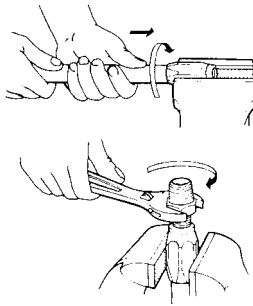

Male Pipe Rigid

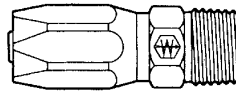

Hose x Pipe	Part No.	Vendor No.	Price /Each
3/16 x 1/8	412424-131280	21304N-102	\$2.36
3/16 x 1/4	412425-131280	21304N-104	5.59
1/4 x 1/4	412426-131280	21305N-104	3.22
5/16 x 3/8	412427-131280	21306N-106	4.81
13/32 x 1/2	412428-131280	21308N-108	19.74
1/2 x 1/2	412429-131280	21310N-108	6.42
5/8 x 3/4	412430-131280	21312N-112	8.72
7/8 x 1	412431-131280	21316N-116	29.47

Inverted Male Swivel Straight



Hose x Tube	Part No.	Vendor No.	Price /Each
5/16 x 1/4	412434-131280	21306N-B04	\$15.78
5/16 x 5/16	412435-131280	21306N-B05	5.98
5/16 x 3/8	412436-131280	21306N-B06	5.44
13/32 x 1/2	412437-131280	21308N-B08	9.78

SAE 37° (JIC) Female Swivel

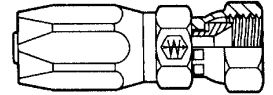

Hose x Tube	Part No.	Vendor No.	SAE OR JIC	Price /Each
3/16 x 1/4	412438-131280	21304N-604	Both	\$3.41
1/4 x 5/16	412439-131280	21305N-605	Both	4.06
5/16 x 3/8	412440-131280	21306N-606	SAE	4.61
5/16 x 3/8	412441-131280	21306N-606	JIC	4.11
13/32 x 1/2	412442-131280	21308N-608	Both	5.76
1/2 x 5/8	412443-131280	21310N-610	Both	10.29
5/8 x 3/4	412444-131280	21312N-612	SAE	23.97
5/8 x 3/4	412445-131280	21312N-612	JIC	21.95
7/8 x 1	412446-131280	21316N-616	JIC	15.92

Inverted Male Swivel 45° Tube Elbow

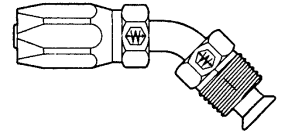

Hose x Tube	Part No.	Vendor No.	Price /Each
3/16 x 1/4	412453-131280	21304N-E44	\$7.20
1/4 x 5/16	412454-131280	21305N-E45	7.84
5/16 x 1/4	412455-131280	21306N-E44	9.34
5/16 x 3/8	412457-131280	21306N-E46	7.80

SAE 37° (JIC) Female Swivel 45° Tube Elbow

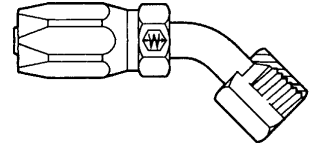

Hose x Tube	Part No.	Vendor No.	SAE OR JIC	Price /Each
3/16 x 1/4	412459-131280	21304N-684	Both	\$9.18
5/16 x 3/8	412461-131280	21306N-486	SAE	8.79
5/16 x 3/8	412462-131280	21306N-686	JIC	10.75
13/32 x 1/2	412463-131280	21308N-688	Both	10.42

Inverted Male Swivel 90° Tube Elbow

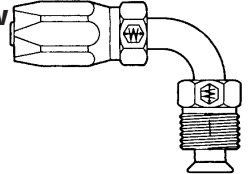

Hose x Tube	Part No.	Vendor No.	Price /Each
3/16 x 1/4	412464-131280	21304N-E04	\$6.73
1/4 x 5/16	412465-131280	21305N-E05	7.20
5/16 x 1/4	412466-131280	21306N-E04	9.77
5/16 x 5/16	412467-131280	21306N-E05	6.68
5/16 x 3/8	412468-131280	21306N-E06	8.04
13/32 x 1/2	412469-131280	21308N-E08	12.93

SAE 37° (JIC) Female Swivel 90° Tube Elbow

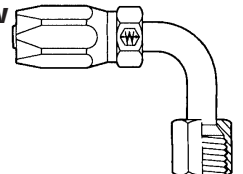

Hose x Tube	Part No.	Vendor No.	SAE OR JIC	Price /Each
3/16 x 1/4	412470-131280	21304N-664	Both	\$8.72
5/16 x 3/8	412472-131280	21306N-466	SAE	10.23
5/16 x 3/8	412473-131280	21306N-666	JIC	8.79
13/32 x 1/2	412474-131280	21308N-668	Both	11.36

FIELD ATTACHABLE HOSE ENDS & FLEET FILTRATION

247 N-Series Field Attachable Hose Ends

EATON Weatherhead

Typical Application: Medium pressure and high temperature hose lines for a variety of applications including truck, industrial and small engine where temperature may be a problem.

Compatible Hose: H059, H069, H166, H169, H229, H366, H569

Pressure: Determined by maximum working pressure for hose size and hose end configuration, whichever is lesser.

Material: AISI/SAE 12L14 Carbon Steel

Plating: Zinc, yellow dichromate finish

Advantages: Very popular in heavy-duty truck markets. Good selection of hose ends. Compatible with a wide variety of hose types allowing for a diverse number of applications. Non-mandrel assembly.

Assembly Instructions:

1. Lubricate insert threads and I.D. of hose.
2. Screw hose into socket (left-hand thread) until hose bottoms. Back out 1/4 turn.
3. Screw insert into socket until insert touches socket.

Label Set: FS-600

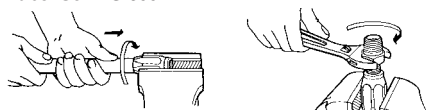

Male Pipe Rigid



Hose x Pipe	Part No.	Vendor No.	Price /Each
3/16 x1/8	411201-131280	24704N-102	\$3.53
3/16 x1/4	411202-131280	24704N-104	3.76
1/4 x1/4	411376-131280	24705N-104	4.96
5/16 x1/4	411203-131280	24706N-104	4.85
5/16 x3/8	411204-131280	24706N-106	6.15
13/32 x3/8	411205-131280	24708N-106	9.50
13/32 x1/2	411206-131280	24708N-108	7.38
1/2 x1/2	411207-131280	24710N-108	8.53
1/2 x3/4	411377-131280	24710N-112	16.33
5/8 x3/4	411208-131280	24712N-112	14.45

SAE 37° (JIC) Male Rigid

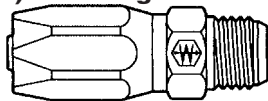

Hose x Tube	Part No.	Vendor No.	Price /Each
3/16 x1/4	411378-131280	24704N-504	\$6.38
1/4 x5/16	411379-131280	24705N-505	18.28
5/16 x3/8	411380-131280	24706N-506	7.80
13/32 x1/2	411381-131280	24708N-508	15.22
1/2 x5/8	411382-131280	24710N-510	16.15
5/8 x3/4	411383-131280	24712N-512	23.36

Flareless Tube Rigid With Nut and Sleeve

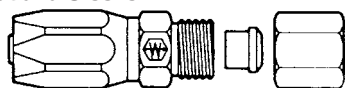

Hose x Tube	Part No.	Vendor No.	Price /Each
5/16 x1/4	411401-131280	24706N-754	\$21.71
5/16 x5/16	411402-131280	24706N-755	15.23
5/16 x3/8	411403-131280	24706N-756	15.30

SAE 37° (JIC) Female Swivel

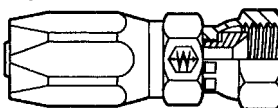

Hose x Tube	Part No.	Vendor No.	SAE OR JIC	Price /Each
3/16 x1/4	411209-131280	24704N-604	Both	\$4.93
1/4 x5/16	411405-131280	24705N-605	Both	6.81
5/16 x1/4	411406-131280	24706N-604	Both	6.23
5/16 x5/16	411407-131280	24706N-605	Both	7.18
5/16 x3/8	411212-131280	24706N-606	JIC 37	6.03
5/16 x1/2	411214-131280	24706N-608	Both	15.11
13/32 x1/2	411210-131280	24708N-608	Both	8.28
1/2 x1/2	411215-131280	24710N-608	Both	21.81
1/2 x5/8	411216-131280	24710N-610	Both	11.38
5/8 x3/4	411211-131280	24712N-612	JIC 37	17.03
7/8 x1	411408-131280	24716N-616	JIC 37	20.97

SAE 45° Flare Female Swivel

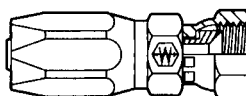

Hose x Tube	Part No.	Vendor No.	Price /Each
5/16 x3/8	411409-131280	24706N-406	\$6.15
13/32 x3/8	411410-131280	24708N-406	15.52

Inverted Male Swivel 45° Tube Elbow

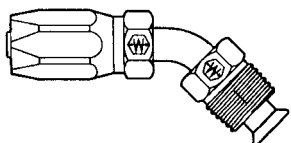

Hose x Tube	Part No.	Vendor No.	Price /Each
1/4 x5/16	411417-131280	24705N-E45	\$11.58

SAE 37° (JIC) Female Swivel 45° Tube Elbow

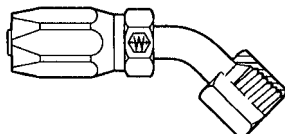

Hose x Tube	Part No.	Vendor No.	SAE OR JIC	Price /Each
3/16 x1/4	411418-131280	24704N-684	Both	\$11.11
1/4 x5/16	411419-131280	24705N-685	Both	14.92
5/16 x3/8	411422-131280	24706N-686	JIC 37	13.54
13/32 x1/2	411423-131280	24708N-688	Both	14.22
1/2 x5/8	411424-131280	24710N-690	Both	22.95
5/8 x3/4	411426-131280	24712N-692	JIC 37	28.72
7/8 x1	411427-131280	24716N-696	JIC 37	28.58

Inverted Male Swivel 90° Tube Elbow

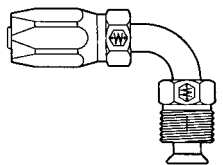

Hose x Tube	Part No.	Vendor No.	Price /Each
3/16 x1/4	411428-131280	24704N-E04	\$8.55
1/4 x5/16	411429-131280	24705N-E05	11.13
5/16 x1/4	411430-131280	24706N-E04	12.85
5/16 x5/16	411431-131280	24706N-E05	13.40
5/16 x3/8	411221-131280	24706N-E06	14.78

SAE 37° (JIC) Female Swivel 90° Tube Elbow

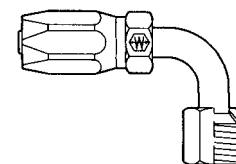

Hose x Tube	Part No.	Vendor No.	SAE OR JIC	Price /Each
3/16 x1/4	411432-131280	24704N-664	Both	\$11.23
1/4 x5/16	411433-131280	24705N-665	Both	15.58
5/16 x3/8	411434-131280	24706N-666	SAE 45	13.83
5/16 x3/8	411435-131280	24706N-666	JIC 37	14.63
13/32 x1/2	411436-131280	24708N-668	Both	20.13
1/2 x5/8	411437-131280	24710N-670	Both	18.65
5/8 x3/4	411439-131280	24712N-672	JIC 37	27.97
7/8 x1	411440-131280	24716N-676	JIC 37	28.60

Fleet Filtration



Donaldson Air Filters

- Expect consistent quality and performance
- Hold over 40 TS and ISO quality and environmental certifications
- Donaldson designs and supplies most original equipment air systems, so our replacement filters are designed to meet or exceed OE standards
- Demand Donaldson!



Pn. 0456481



Pn. 0456172



Pn. 0456689

Air Cleaner/Filter

Part No.	Vendor No.	Description	Length	Price /EA
0456481	P537454	Racor Eco SE W/Side Inlet	19.4	\$122.43
0456172	P537450	Racor Eco CM 13.5 x 24	24	192.98
0456689	P154927	Racor EcoII #71338-002, United F-EcoII 11 x 24	25.75	99.06

FLEET FILTRATION

Fleet Filtration Cont.



Donaldson.



Primary Air Filter

Part No.	Vendor No.	Description	Length	Price /EA
0454641	P607353	John Deere AL78223	12.27	\$93.77
0454701	P771559	Freightliner FLN, EPG11 or FRG11 AC	18.5	35.68
0454756	P778361	Gardner Denver 8507413	13	19.43
0456197	P181014	EBA13 A/C, Ford D5HZ9601D	15	56.49
0455776	P181016	EBA13 A/C, White, Freightliner	26	70.38
0456392	P181028	EBB12 or EGB12 A/C IHC 476741C1	16	47.36
0455446	P544765	ECG11 Air Cleaner	20.04	73.25
0455437	P181082	FTG13 Cyclopac A/C	20	83.30
0456199	P181046	FHG14 Cyclopac A/C	16	39.26
0455971	P181015	EBB14 or EGB14 A/C IHC 476743C1	18	61.79
0455978	P181096	EBB15 A/C, Volvo/White 22005-3202	15	62.06
0455246	P182002	Long Life Version of P181002	18	65.35
0455553	P181009	EBA15 A/C	26	51.28
0455556	P181049	FVG16 Cycloflow A/C	24.03	117.26
0455242	P181186	Vortex VF160R	26	75.30
0455252	P182049	Long Life Version of P181049	24.03	144.89
0455639	P181095	EBB16 A/C, Volvo/White 22005-3201	15.5	68.19
0454984	P181099	EBB16, IHC, GMC	18.06	63.30
0455924	P181189	Ford E2HZ9601B	10	80.66
Konepac				
0456173	P129472	EBA09- Treated W/CVR Gasket	28	66.70
0455753	P129396	EBA11- Treated W/CVR Gasket	28	78.81
0455682	P141317	IHC 574844C1	22	70.66
0455760	P150694	ECG11 - Stand.	28	61.79
0455762	P151097	EBA11 - Stand.	28	77.26
0455786	P522293	EBA11	28	75.51
0455552	P150695	ECG11	28.02	86.92
0455217	P155842	Short ECG11 A/C, GMC 15527863	20.02	76.06
0455561	P521598	EBA13, Kenworth, Peterbilt	24	79.79
0455551	P142100	EBA13 - Treated	24	100.96
0455550	P141228	EBA13 Air Cleaner	28	115.18
PowerCore				
0455993	P607960	Freightliner M2 Series Flame Retardant	7.99	93.28
0455992	P607955	Freightliner M2 Series High HP	7.99	65.81
0455646	P607965	Freightliner M2 Series High HP	7.99	98.81
Radial Seal				
0456030	P534096	Peterbilt Truck, Model 385	23.03	66.64
0456212	P537355	ERA11 Air Clnr, Freightliner Classic	24.61	66.65
0454895	P533930	EPG13 Air Cleaners	15.15	52.64
0455265	P542753	Peterbilt, ERA13	21.19	78.81
0455988	P532505	Caterpillar 61-2505, 1P-8482	15.02	68.70
0455266	P544243	Peterbilt, ERA15	21.38	83.15
0456685	P534925	Kenworth & Peterbilt Conventionals	25.44	67.15
0455258	P533235	Navistar 2005895C1	18.15	42.98
0455564	P540388	Volvo 8076195	15.94	44.22
0455260	P533938	Ford F6HZ9601CA, Motorcraft FA1637	17.24	92.23

Secondary Air Filter

Part No.	Vendor No.	Description	Length	Price /EA
0454642	P607354	John Deere AL78224	5.2	\$52.59

Safety Air Filter



Part No.	Vendor No.	Description	Length	Price /EA
0454823	P782300	Dynapac 380294	8.89	\$11.85
0456684	P533814	Ford F6HZ9601BA, Motorcraft FA1636	16.85	84.80
0456525	P778906	Volvo 11110176	3.7	26.36

Spin-on Air Dryer



Part No.	Vendor No.	Description	Length	Price /EA
0454805	P781466	Mercedes-Benz: Actros I, Actros II, Atego, Vario	6.5	\$48.56

Ventilation Panel Air Filter

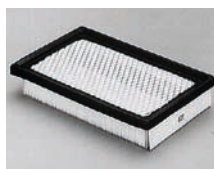

Part No.	Vendor No.	Description	Length	Price /EA
0454565	P607277	Chrysler 53032404AA	2.05	\$42.24

Donaldson Engine Liquid Filters

- Lube, fuel, and coolant diesel engines filters
- Expect consistent quality and performance
- Hold over 40 TS and ISO quality and environmental certifications
- Designed for durability
- Demand Donaldson!



Lube Filters

Part No.	Vendor No.	Description	Length	Price /EA
Cartridge				
0455621	P550425	Volvo 4775565	10.36	\$16.00
Full Flow				
0457741	P550521	Mercedes 1041800109	6.2	7.47
0457744	P550564	Mercedes 6111800009	4.53	14.38
0457746	P550761	Mercedes 0001801709	8.24	15.49
0457749	P550768	Mercedes 0001801609	5.8	14.91
0456383	P550286	Mack 57GC2134	4.58	12.32
0456374	P550769	Mercedes 0001802109	9.76	16.21
Full Flow, Spin-On				
0455892	P169556	Cummins	8.94	78.08
0455102	P550367	Navistar 1819452C1	12.1	23.62

Fuel Filters



Part No.	Vendor No.	Description	Length	Price /EA
Water Separator				
0456234	P558000	Cummins	7.4	\$9.48
0456061	P551001	Cummins Celest & Quantum Engines	7.98	17.64
0456067	P558010	Detroit Diesel 23512317	7.36	15.19
0455455	P552020	Racor 2020SM	9.63	8.57
0457001	P550730	Ford F1HZ9365A, Carrier 30-01079	5.1	23.60
Primary, Spin-On				
0454908	P551315	Caterpillar 1R-0759	6.93	11.60
0456450	P550105	Cummins 154709	5.35	4.37
0456479	P557440	Cat 1R-0711, 1P-2299, 6I-7440, KTSU 600-311-8290	6.85	5.11
0456925	P550372	Volvo 420799	8.13	9.10
0456142	P554470	Mack 483-GB-470M	7.95	12.64
0456128	P550219	Mack 483-GB-219A	7.89	9.25
0455950	P555823	Cat 4N-5823	10.6	12.34
Primary, Cartridge				
0456822	P550632	Mercedes 0000901551	3.98	17.96
0456825	P550762	Mercedes 5410900151	7.97	14.09
0455622	P550463	Davco 380/382 Series Detroit Diesel Engines	6.74	7.28
Secondary, Spin-On				
0456319	P551313	Caterpillar 1R-0750	6.95	11.52
0456064	P552200	Cummins 4088272, Fleetguard FF2200	9.18	15.50
0455949	P554471	Mack 483GB471M	10.3	15.56
0455946	P550431	Mack 483-GB-431	10.31	12.61
0455832	P552603	IHC 672603C1	7.98	10.87

Coolant Filters



Part No.	Vendor No.	Description	Length	Price /EA
Spin-On				
0456272	P554860	Mack 25-MF-314A	5.35	\$9.60
0456464	P554019	Volvo 3645411	5.35	14.80
0454949	P552071	Cummins 3315116	4.15	7.59

Coolant Additive

Part No.	Vendor No.	Description	Price /Each
0456506	X006136	1Pint/16oz SCA Formula	\$3.92