

EMISSION SUB SYSTEMS - Evaporative Emission Control System

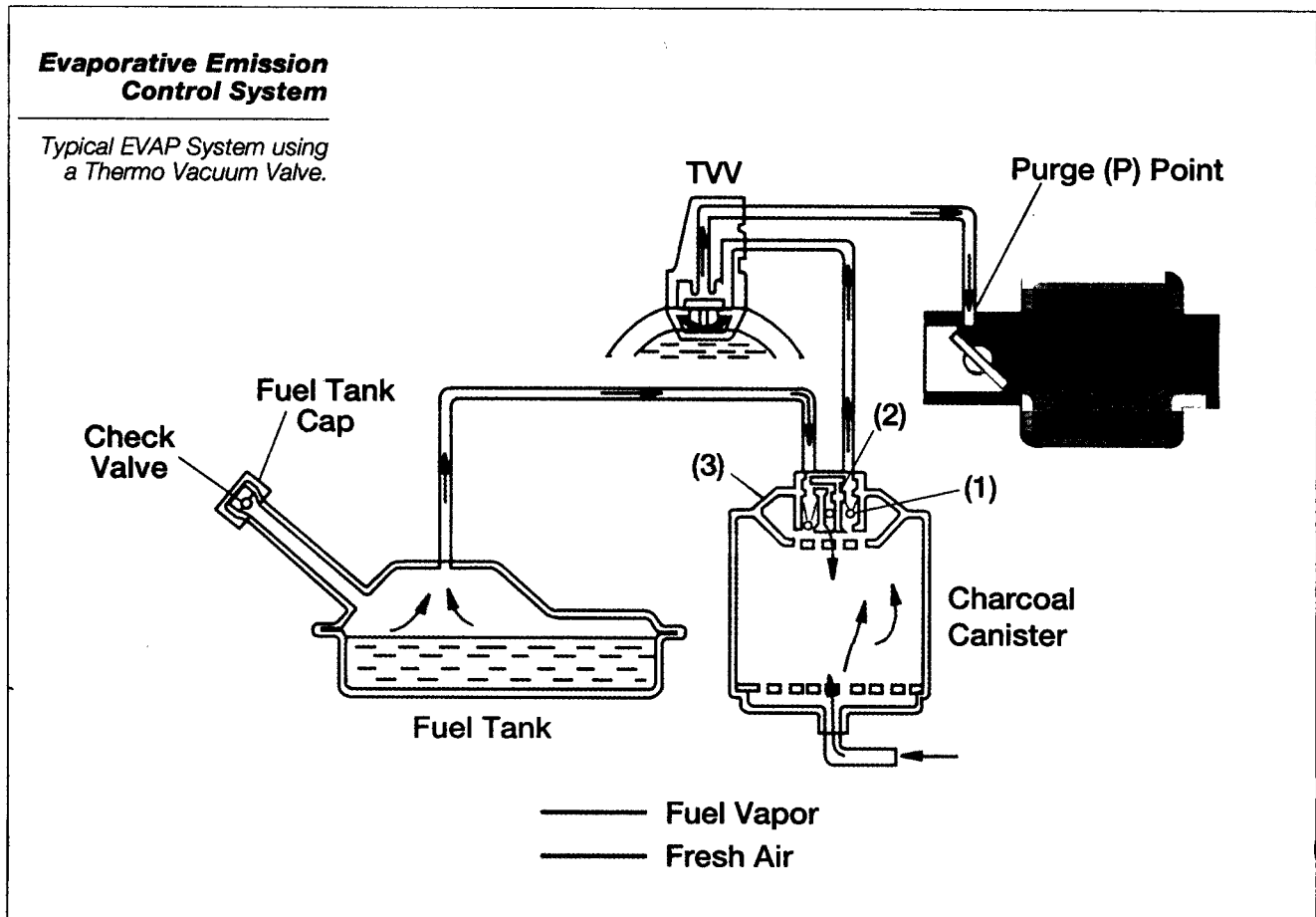

Evaporative Emission Control System

Approximately 20% of all hydrocarbon (HC) emissions from the automobile originate from evaporative sources. The Evaporative Emission Control (EVAP) system is designed to store and dispose of fuel vapors normally created in the fuel system; thereby, preventing its escape to the atmosphere. The EVAP system delivers these vapors to the intake manifold to be burned with the normal air/fuel mixture. This fuel charge is added during periods of closed loop operation when the additional enrichment can be managed by the closed loop fuel control system. Improper operation of the EVAP system may cause rich driveability problems, as well as failure of the Two Speed Idle test or Enhanced I/M evaporative pressure or purge test.

The EVAP system is a fully closed system designed to maintain stable fuel tank pressures without allowing fuel vapors to escape to the atmosphere. Fuel vapor is normally created in the fuel tank as a result of evaporation. It is then transferred to the EVAP system charcoal canister when tank vapor pressures become excessive. When operating conditions can tolerate additional enrichment, these stored fuel vapors are purged into the intake manifold and added to the incoming air/fuel mixture.

EMISSION SUB SYSTEMS - Evaporative Emission Control System

Toyota vehicles use two different types of evaporative emission control systems:

- **Non-ECM controlled EVAP systems** use solely mechanical means to collect and purge stored fuel vapors. Typically, these systems use a ported vacuum purge port and a Thermo Vacuum Valve (TVV) to prohibit cold engine operation.
- **ECM controlled EVAP systems** uses a manifold vacuum purge source in conjunction with a duty cycled Vacuum Switching Valve (VSV). This type of EVAP system has the ability to provide more precise control of purge flow volume and inhibit operation.

Non-ECM Controlled EVAP System

Non-ECM controlled EVAP systems typically use the following components:

- Fuel tank
- Fuel tank cap (with vacuum check valve)
- Charcoal canister (with vacuum & pressure check valves)
- Thermo Vacuum Valve (TVV)
- Ported vacuum purge port (port P; on throttle body)

EVAP System Operation

Under some conditions, the fuel tank operates under a slight pressure to reduce the possibility of pump cavitation due to fuel vaporization. Pressure is created by unused fuel returning to the tank and is maintained by check valve #2 in the charcoal canister and the check valve in the fuel tank cap.

Under other conditions, as fuel is drawn from the tank, a vacuum can be created in the tank causing it to collapse. This is prevented by allowing atmospheric pressure to enter the tank through check valve #3 in the charcoal canister or the fuel tank cap check valve. The EVAP system is designed to limit maximum vacuum and pressure in the fuel tank in this manner.

When the engine is running, stored fuel vapors are purged from the canister whenever the throttle has opened past the purge port (port P) and coolant temperature is above a certain point (usually around 129° F). Fuel vapors flow from the high pressure area in the canister, past check valve #1 in the canister, through the Thermo Vacuum Valve (TVV), to the low pressure area in the throttle body. Atmospheric pressure is allowed into the canister through a filter located on the bottom of the canister. This ensures that purge flow is constantly maintained whenever purge vacuum is applied to the canister.

When coolant temperature falls below a certain point (usually around 95°F), the TVV prevents purge from taking place by blocking the vacuum signal to check valve #1.

EMISSION SUB SYSTEMS - Evaporative Emission Control System

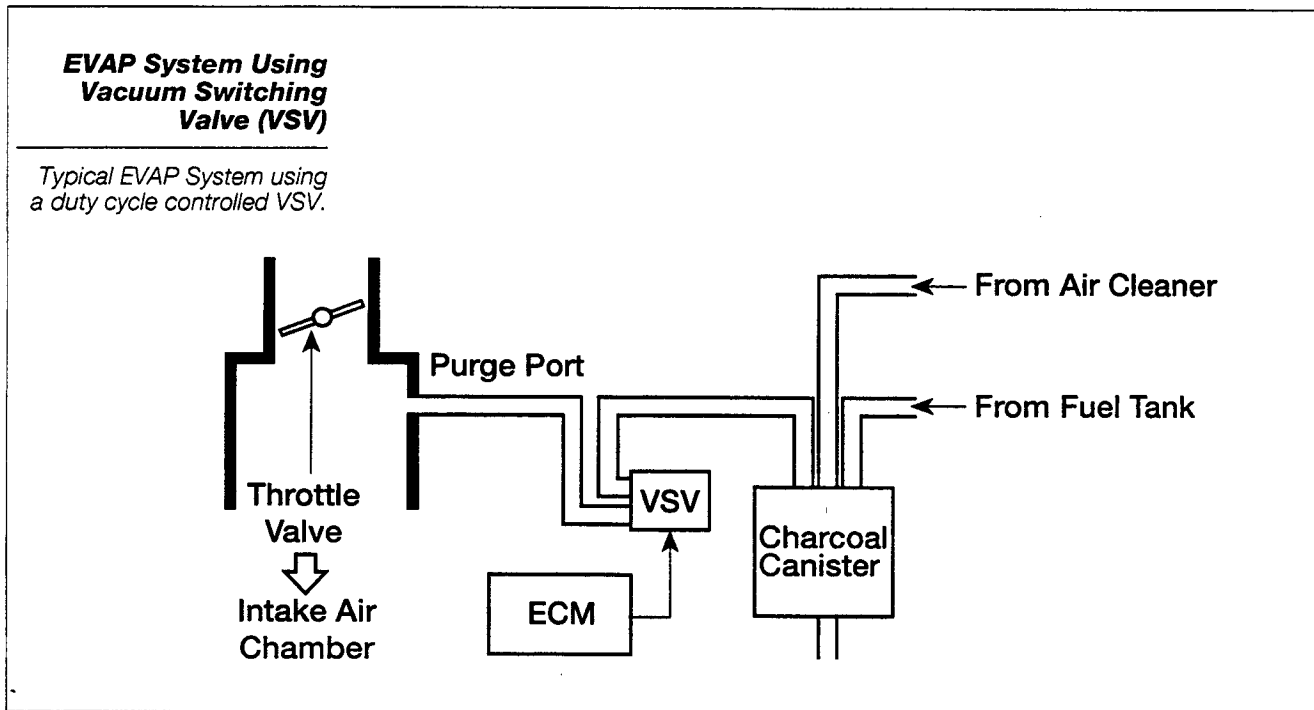

ECM Controlled EVAP System Operation

Introduced on the '95 Avalon for CA, this system is similar to the Non-ECM controlled systems, except that an ECM controlled Vacuum Switching Valve (VSV) is used in place of the Thermo Vacuum Valve (TVV). The VSV is normally closed and duty cycle controlled, which means the ECM rapidly opens and closes the VSV passage to provide precise, variable control of purge flow volume and inhibit operation.

Because this system uses a manifold vacuum purge port, it may provide slight purge flow during idle if conditions can tolerate its enrichment. The ECM uses engine speed, intake air volume, coolant temperature, and oxygen sensor information to control EVAP operation.

EVAP Purge System Monitoring

By monitoring the oxygen sensor and injection pulse width as the canister is being purged, the ECM can detect the reduction of exhaust oxygen content and corresponding decrease in injection pulse width to correct for this momentary rich condition. In this manner, the ECM can detect a failure in the EVAP purge control system and store a DTC to alert the vehicle operator of the malfunction. Purge flow monitoring is only used on '95 and later OBD-II equipped vehicles.

EVAP Effect on Emissions and Driveability

During Two Speed Idle tests, it is not uncommon for vehicles to fail off idle tailpipe tests for excessive CO emissions due to normal evaporative purge cycle operation. It is also possible for the charcoal canister to become saturated with liquid fuel to the degree that it becomes unserviceable.

EMISSION SUB SYSTEMS - Evaporative Emission Control System

To avoid emissions failures due to normal evaporative emissions purge cycle, the vehicle should not be tested after long hot soak periods, prolonged idle or after having been left in sitting in the sun on a hot day. All of these conditions will cause large amounts of fuel vapor to store in the charcoal canister. To put the EVAP system through it's normal purge cycle, the vehicle can be driven at highway speeds for five minutes. This should purge any vapor from the canister which would normally accumulate during the above mentioned conditions.

If the canister continues to cause high CO emissions after a normal purge cycle has been performed, it is possible that the canister is irrecoverably saturated. If the EVAP is suspected as potential cause of high CO emissions failure or rich driveability problems, the following checks should be made:

- Isolate the EVAP system from the engine intake by removing the purge port hose from throttle body port.
- Test vehicle with EVAP system isolated.

If the EVAP system is determined to be at fault, use procedures in the appropriate Repair Manual to inspect the charcoal canister, filter, check valves, TVV or VSV and the related vacuum plumbing.

EMISSION SUB SYSTEMS - Evaporative Emission Control System

Enhanced I/M EVAP Purge and Pressure Test Diagnosis

Evaporative System Purge and Pressure Tests will be required as a part of Enhanced I/M testing. If the vehicle fails for either purge or pressure, checks can be made to verify the operation and integrity of evaporative control system.

EVAP System Pressure Test Diagnosis

The Enhanced I/M Evaporative Pressure Test is performed by filling the EVAP vapor line and fuel tank with nitrogen to a pressure of 14 inches of water (approximately 0.5 psi). If the system maintains at least 8 inches of water pressure after 2 minutes, it passes the test.

Warning!

Because of difficulty regulating compressed air, and the hazardous nature of introducing oxygen to stored fuel vapors, never attempt to pressurize the EVAP system using shop air!

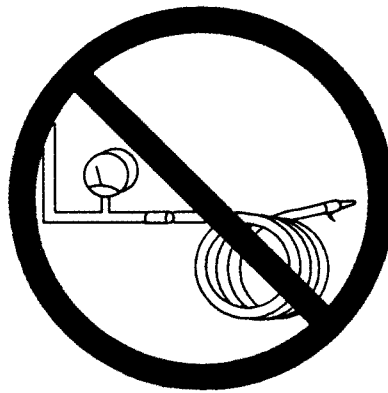

If the EVAP system fails the pressure test, a leak exists either in the vapor vent line between the canister and tank, the fuel tank itself, or the fuel cap. Visual checks may or may not identify the source of leak(s) in the system; however, you should never pressurize the EVAP system with shop air! Doing this would introduce oxygen into the EVAP system where it could combine with fuel vapors and create a very explosive condition. Secondly, the system is tested at very low pressure which would make accurate, pressure regulation difficult. If the system was accidentally pressurized beyond this point, severe damage to the system may result.

EMISSION SUB SYSTEMS - Evaporative Emission Control System

EVAP Pressure Testing (Using Special Test Equipment)

Aftermarket test equipment may be used to accurately pressure test the EVAP system similar to the method used in IM240.

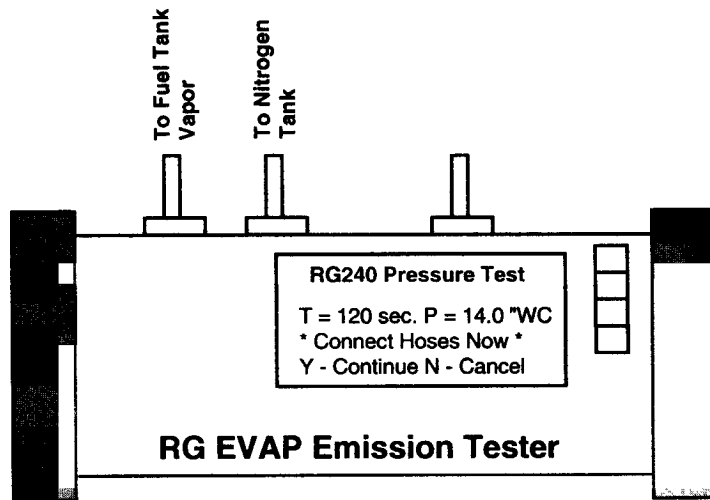

EMISSION SUB SYSTEMS - Evaporative Emission Control System

EVAP Pressure Testing Using Special Test Equipment

The best way to test and identify leak(s) that cause a pressure test failure is to use special EVAP pressure testing equipment available from aftermarket suppliers. This equipment allows you to perform an actual pressure test, in addition to having features that help you locate the leak. There are many variations and differences between test equipment and procedures, but for the sake of example, here is the test procedure for an EVAP pressure tester that uses pressurized nitrogen gas:

1. Disconnect the fuel tank vapor line from the canister and attach the pressure tester to this line.

Note: The tester may have an adapter that allows you to connect the pressure line between the tank filler neck and the fuel cap.

2. Activate the tester and pressurize the line until 14 inches of water pressure is maintained.
3. Observe the pressure gauge and note if the pressure begins to drop.

Note: It is normal for pressure to initially rise or fall slightly then stabilize after a few seconds. This is caused by the initial temperature variation between the nitrogen and EVAP fuel vapors. Once temperatures stabilize, the pressure will equalize if no leak exist.

4. If the pressure drops dramatically, listen for leaks from the fuel cap, tank seams, and hoses.
5. Check for frayed or cracked hoses, poor connections, damaged fuel tank seams, faulty fuel cap gasket or check valve.
6. The leak may be found by spraying the suspected area with soapy water and looking for bubbles.
7. Special ultrasonic leak detectors are now available that can "listen" for the exact frequencies caused by these low pressure leaks. Another method uses the exhaust analyzer to check for the escape of fuel vapors (HC) from the leaky part/component.

Note: The drawback to using the exhaust analyzer is the limited amount of fuel vapors that exist in EVAP system (fuel tank). If the leak is not quickly identified, all HC vapors will escape leaving only a nitrogen (inert gas) leak to locate.

8. If the leak cannot be identified by the completion of the test, select the manual mode that provides a constant pressure on the system.
9. Once the leaky part/component is identified, perform the needed repair or replacement.

EMISSION SUB SYSTEMS - Evaporative Emission Control System

EVAP Purge Test Diagnosis

The evaporative purge test is performed during the IM240 transient (drive cycle) test. A flow transducer is placed in series with the purge line between the canister and engine. In order to pass, the system must purge at least 1 liter of flow by the end of the IM240 drive cycle. Toyota vehicles with properly operating EVAP systems normally purge 25 liters or more by the completion of drive cycle.

If the EVAP system fails the purge test, a problem exists with the purge port, the purge hose to the canister, or the charcoal canister itself. Since 1 liter of flow is such a nominal amount, the test really only verifies whether the system is purging or not. There are checks that you can make to confirm vacuum to the canister or the effects of purge flow on the air/fuel mixture; however, the only real way of measure actual flow volume is to use a flow transducer, similar to the one used in the actual purge test.

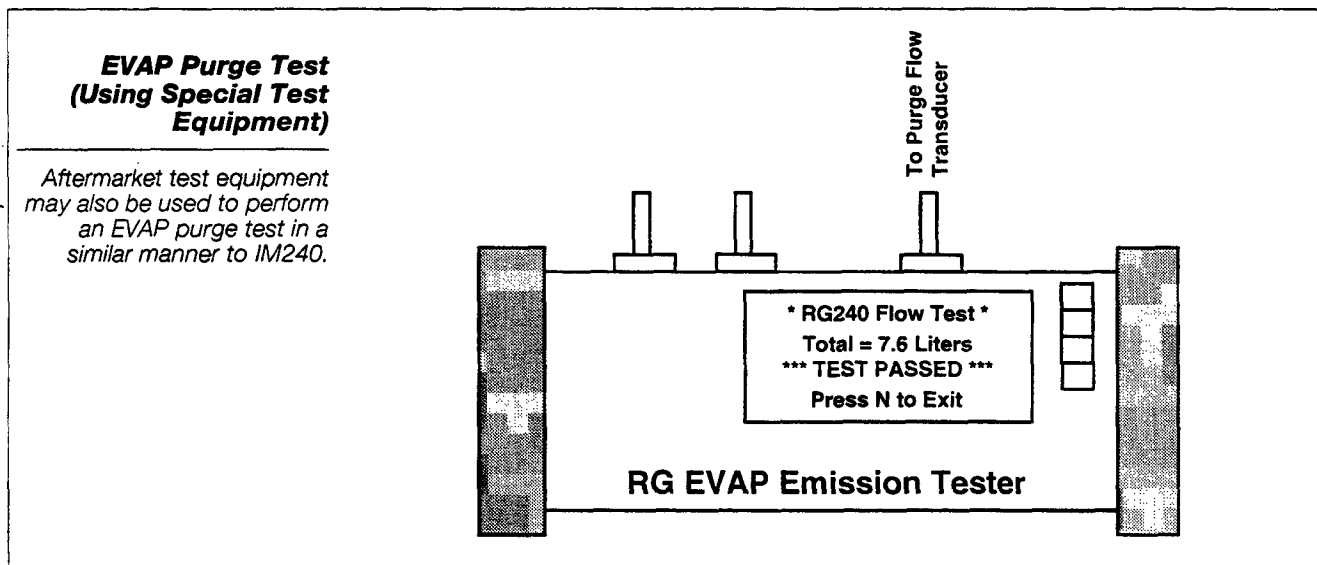

EVAP Purge Test Using Special Equipment

The most accurate method of checking EVAP purge flow is to check the system in the same manner in which it was tested. EVAP purge flow testers (sometimes combined with pressure testers) are currently available from aftermarket sources and typically operates as follows:

1. Precondition the vehicle by running the engine until it reaches operating temperature.
2. Connect the tester's flow transducer into the EVAP purge line between the engine and evaporative canister.
3. With the engine off, zero the tester to calibrate the purge flow reading.
4. Next, with the engine idling, start the timer and observe the purge flow rate and accumulated purge volume on the tester display.

EMISSION SUB SYSTEMS - Evaporative Emission Control System

Note: On TVV equipped systems that use a ported vacuum purge source, no purge should take place during idle, however, on systems using a VSV, the ECM may command a very slight amount of flow during idle.

5. Slowly raise engine speed and maintain a steady 2500 rpm. During this period purge flow should increase dramatically and, on a properly functioning EVAP system, 1 liter of flow should be surpassed in a matter of seconds.
6. If the system does not flow at least 1 liter within the 240 second test period or it marginally passes the test, perform the following functional checks to help identify the suspect parts or components.

Note: Since most vehicles flow 25 liters or more during the same period, marginal passes should also be checked and repaired since these systems are not functioning properly and will probably fail in future tests.

7. Once the problem has been identified and repaired, perform this test again to confirm sufficient improvements in purge volume.

EMISSION SUB SYSTEMS - Evaporative Emission Control System

EVAP System Check

If the system fails the purge flow test or flows very little, the following Evaporative Emission System Check may help identify problems causing no or low purge flow. The following inspection procedures are for a '95 5S-FE Camry:

1. First, visually inspect the fuel tank, fuel cap, canister, lines and connections for any damage, cracks, fuel leakage, or deterioration and repair or replace as necessary.
2. Check the canister for a clogged filter or stuck check valve by performing the following:
 - Apply low pressure compressed air (0.68 psi) into the fuel tank vapor port (port A) of the canister and confirm that air flows out from all other canister ports.

Note: Airflow from canister ports is difficult to detect.

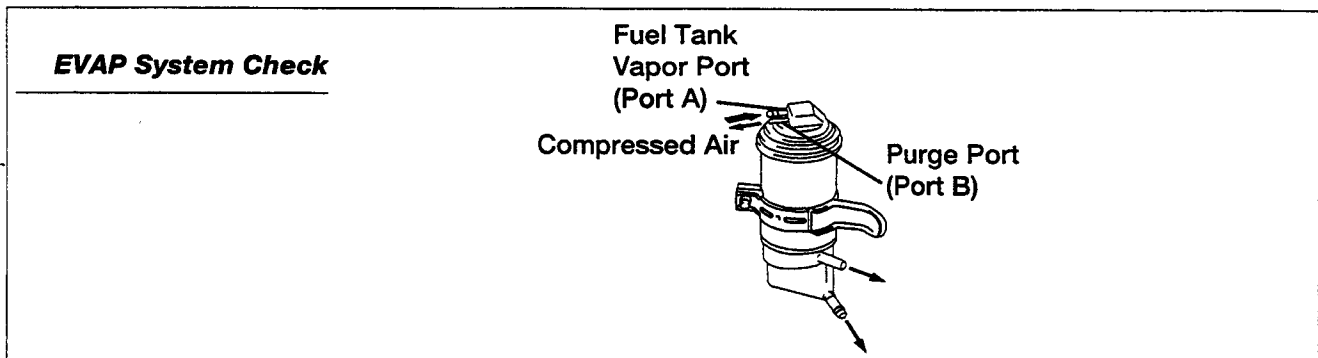

- Next, apply low pressure compressed air to the purge port (port B) of the canister and confirm that air does not flow out from any of the other ports.

Note: Replace the canister if a problem is detected with either of the checks above.

- Clean the canister filter by applying air pressure (43 psi) to the tank vapor port (port A) while holding the purge port (port B) closed with your finger.

Note: If carbon blows out during this test replace the canister.

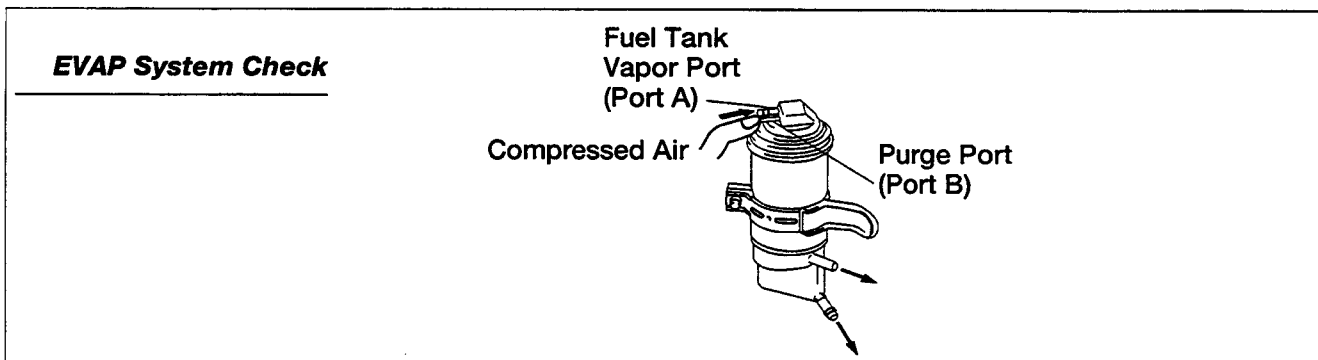

EMISSION SUB SYSTEMS - Evaporative Emission Control System

3. Check the operation of the TVV by performing the following:

- Disconnect the hoses from the TVV and then attach a hand operated vacuum pump to the lower port of the TVV.
- With coolant temperature cold (below 95°F), operate the vacuum pump and confirm that air does not flow (vacuum is held) from the upper port to the lower port.
Note: It is normal for some TVVs to allow a slight amount of airflow when cold.
- Next, allow coolant temperature to rise above 129° F. Operate the vacuum pump and confirm that air now flows (vacuum bleeds off) between the top port and the lower port.

Note: If the TVV fails any of the checks above, replace it.

This EVAP check example systematically confirms the integrity of the evaporative canister and TVV. Once repair or replacement is made, retest the system to confirm sufficient purge improvement needed to pass a retest. Because slight variations exist between evaporative system tests, refer to the Repair Manual for specific EVAP test procedures and specifications.